

FAN USE

Fully controlled, low-pressure RP radial fans intended for the square duct can be universally used for complex air-conditioning, from simple venting installations to sophisticated air-handling systems. Ideally, they can be used along with other components of the Ven-to modular system which ensure inter-compatibility and balanced parameters.

OPERATING CONDITIONS, POSITION

These fans are designed for indoor applications. Outdoor applications are possible providing sufficient roofing is ensured. They are designed to transport air without solid, fibrous, sticky, aggressive, respectively explosive impurities. For outdoor applications it is necessary to finish the fans with a protective coating (except rating plates). The transported air must be free of corrosive chemicals or chemicals aggressive to zinc and/or aluminium. Acceptable temperature of transported air can range from -30 °C to +40 °C, and with certain types up to +70 °C. The maximum nominal values for each fan are included in table 6. The RP fans can work in any position. When positioned under the ceiling, it is advisable to situate the fan with the motor cup directed downwards to ease access to the motor terminal box. However, if the transported air is oversaturated with moisture or if the risk of intensive steam condensation inside the fan exists, it is better to situate the fan's cup upwards. We recommend adding a 1-1.5 m long piece of straight duct to the fan's outlet to reduce pressure losses in an assembly.

DIMENSIONAL RANGE

P fans are manufactured in a range of nine sizes according to the A x B dimensions of the connecting flange. Several fans differing in the number of motor poles are available for each size. When planning the fan for the required air flow and pressure, the following

FIG. 1 – DIMENSIONS

A × B [mm]	
400-200	40-20
500-250	50-25
500-300	50-30
600-300	60-30
600-350	60-35
700-400	70-40
800-500	80-50
900-500	90-50
1000-500	100-50

general rule is applied; the larger fans with higher number of poles reach the required parameters at lower RPM, which results in lower noise and longer service life. Fans with higher number of poles also have lower air velocity in the cross section, which results in lower pressure losses in the duct and accessories, however, at higher investment costs. The standard dimensional and performance range of single-phase and three-phase RP fans enables the designers to optimize all parameters for air flow up to 9,200 m³ per hour.

MATERIALS

The external casing and connecting flanges of RP fans are made of galvanized steel sheets (Zn 275 g/m²). Impeller blades – with forward curved blades are made of galvanized sheet steel, diffusers are made of aluminium. Motors are made of aluminium alloys, copper and plastics.

MOTORS

Compact single-phase and three-phase asynchronous motors with an external rotor and a resistance armature are used as drives. The motors are situated inside the impeller, and during operation are optimally cooled by the flowing air. The motor's high quality enclosed ball bearings with permanent lubricating filling enable the fans to reach a service life above 40,000 operating hours without maintenance. The motor electric protection degree is mostly IP 54 for RP 40-20 and IP 44 for RP 50-25. The motors feature low build-up current.

ELECTRICAL EQUIPMENT

Single-phase motors are equipped with a starting capacitor which is mounted on the fan casing. The wiring is terminated in a terminal box of IP 54 protection degree. For wiring diagrams, refer to the section "The Wiring".

MOTOR PROTECTION

As standard, permanent monitoring of the internal motor temperature is used in all motors. The limit temperature is monitored by thermal contacts (TK-thermo-contacts) situated in the motor winding. The thermo-contacts are miniature thermal tripping elements which after being connected to the protective contactor circuit protect the motor against overheating (damage) due to phase failure, forced motor braking, current protection circuit breakdown or excessive temperature of transported air. Thermal protection by means of thermo-contacts is comprehensive and reliable providing they are correctly connected. This type of protection is essential especially for speed controlled and frequently started motors and motors highly thermally loaded by hot transported air.

Therefore, the fan motors cannot be protected by conventional thermal protection ensured by the motor overcurrent protective elements!

Maximum thermo-contact permanent loading is 1.2 A at 250V / 50 Hz (cos φ 0,6) je 1,2 A (resp. 2 A respectively cos φ 1,0).

FAN OUTPUT CONTROL

The output of all RP fans can be fully controlled by changing the speed. The fan's speed is changed depending on the voltage at the motor terminals. The fan parameter tables contain voltage controllers corresponding to each fan. Generally, several types of control can be used with fans. However, voltage control is the most suitable for RP fans.

Five Stage Voltage Control (Transformer)

Voltage control of single-phase and three-phase RP fans is the most suitable, technically as well as operationally. There is no interference, humming, squeaking or vibration of the motor.

RP fans can be steplessly controlled providing the change in voltage is stepless. In practice, stage voltage controllers are usually used. TRN stage voltage controllers can control the fan output in five stages in 20% steps, refer to Table 1 showing the correlation between the input voltage and selected stage of the controller for single-phase and three-phase motors.

RP fan motors can be operated within a range of approx. from 25 % to 110 % of the rated voltage. All values respect the 400/230 V power supply system. The range of TRN controllers is intended to control the speed, respectively output, of all Vento fans. The possibility of remote control (by manual switch or by a switch in the control unit, respectively by automatic switching of five stages based on the external control signal of 0–10 V from the OSX control unit) is a significant feature of this product line.

This product line includes single-phase and three-phase TRN controllers. These controllers cover every type of Vento fan. Simplified TRR controllers can also be used; however, they do not provide protection function.

Stepless Electronic Control

Stepless electronic voltage control of the output is offered only with single-phase fans. The disadvantage of electronic control provided by PE 5 controllers is greater warming of motors. A partial disadvantage is also the fact that the designer does not have the possibility to exactly define for the user the stage of required output related to the load of the ventilated space. Stepless control can be provided by means of frequency inverters, which can be delivered on request.

ACCESSORIES

RP fans belong in the wide range of Vento modular venting and air-handling system components. Any air-handling set-up, from simple venting to sophisticated comfortable air-conditioning, can be created by selecting suitable elements. Universal duct RP fans can be used along with a wide range of elements and accessories:

- KFD Bag Filters and KF3, KF5, KF7 Filter Inserts
- VFK Insert Air Filters and VF3 Filter Inserts
- VFT metal grease filters and spare VT3 cells
- DV Elastic Connections
- LKR, LKS, LKSX, and LKSF Regulating and Closing Dampers
- PK Pressure Dampers
- PZ Louvers
- TKU Splitter Attenuators
- VO Water Heaters
- SUMX Mixing Sets
- EO, EOS, EOSX Electric Heaters
- CHF Direct Coolers
- CHV Water Coolers
- HRV Plate Heat Exchangers
- SKX Circulating Air Mixing Chambers
- VLH humidification chambers and steam humidifiers
- řídicí jednotky a čidla
- TRN Controllers, ORe 5 controllers, TRRE, TRRD Controllers, respectively PE controllers
- STE, STD Protecting Relays

TABLE 1 – THE INPUT VOLTAGE AND CONTROLLER'S STAGE

MOTOR TYPE	CURVE CHARACTERISTICS – CONTROLLER'S STAGE				
	5	4	3	2	1
1 – phase	230 V	180 V	160 V	130 V	105 V
3 – phase	400 V	280 V	230 V	180 V	140 V

RP
RQ
RO
RE
RF
RPH
EX
TR..
EO..
VO
SUMX
CHV
CHF
HRV
HRZ
PRI

FIGURE 2 – TYPE DESIGNATION OF RP FANS

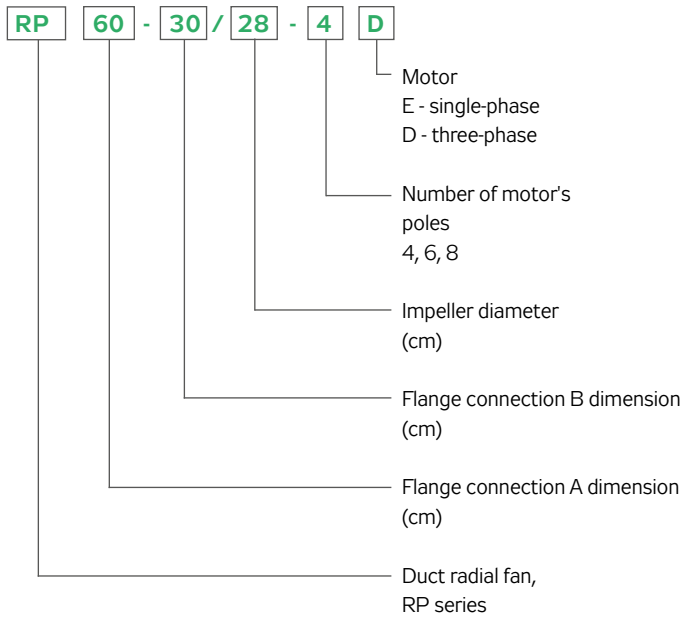

FAN DESCRIPTION AND DESIGNATION

The key for type designation of RP fans in projects and orders is defined in figure # 2.

For example, type designation RP 60-30/28-4D specifies the type of fan, impeller and motor.

The most used names of the fan's individual parts and structure assemblies are defined on the fan's sectional view (see figure # 3).

FIGURE 3 – RP FAN SECTIONAL VIEW

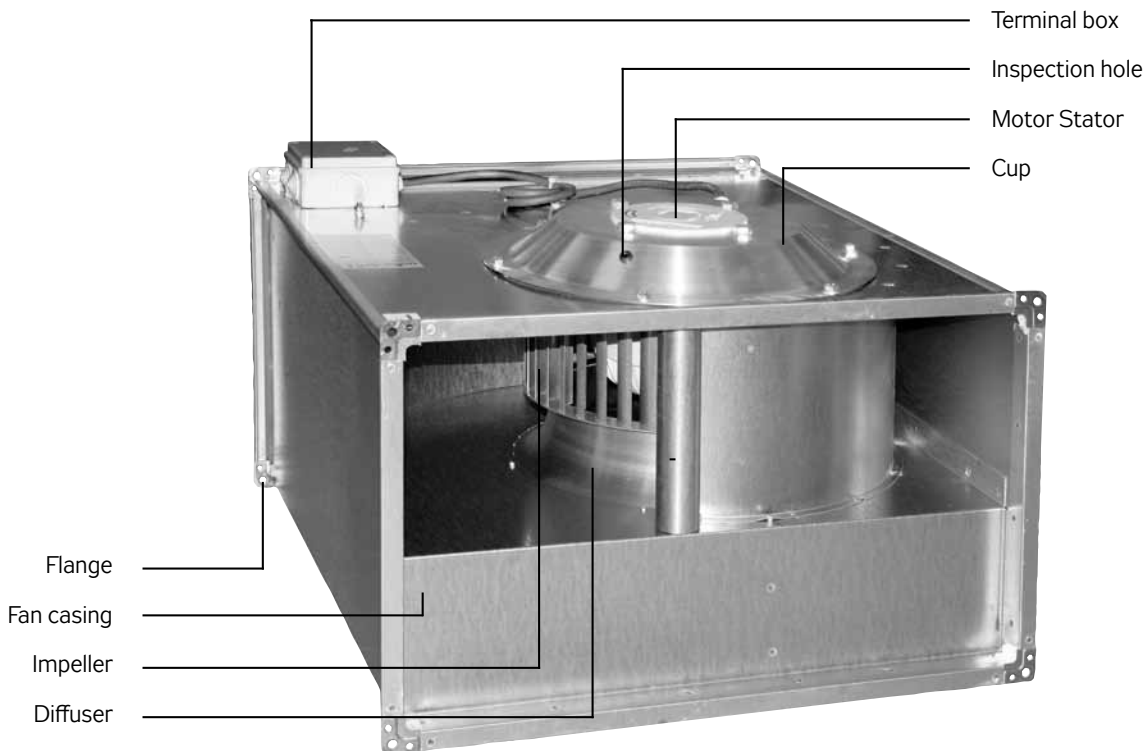

OPERATING CHARACTERISTICS

The output characteristics of RP fans are measured in REMAK testing laboratory for aerodynamic and electric measurements of fans and pressure losses of passive elements. The Remak testing laboratory complies with EN 24 163 and AMCA STANDARD 210-74 Standards. The following text explains the relationships and correlation between important data contained in the "Data Section" of the catalogue.

Output characteristics in the "Data Section" starting on page 17 determine the relationship curve of the air flow rate V (m^3/h) and total fan pressure $\Delta p_t = \Delta p_s + p_d$ (Pa). The example in Graph 1 gives a detailed explanation. All RP fans are fully controllable, and connected to the TRN controller.

Each output stage set on the controller (stage 5, 4, 3, 2, and 1) corresponds to one of the characteristic curves 5 4 3 2 1. If no controller is connected to the fan, the fan can only be operated in accordance with curve 5. The characteristic of the particular duct system has a parabolic map curve of the relation $V-\Delta p_t$ (e.g. curve 6). The effective working point 8 of the fan - duct system will lie at the intersection of the fan curve corresponding to the selected output stage and the curve of the connected duct system. The output of the fan controlled by changing the voltage is dependent on the load. Therefore, not only are the voltage and speed changed but also the current and input. The tables next to the characteristics in the "Data Section" of this catalogue always include changes in these values for three selected points of each working characteristic, e.g. 5a, 5b and 5c of characteristic 5.

Some RP fans have a so-called forbidden area. The forbidden (non-working) area 9 is defined by the dashed lines, and it is marked in the graph when any characteristic ends with point "c", e.g. 5c, which does not lie on the dynamic pressure curve "p_d".

Such fan must not be operated with a free inlet or free outlet; it must always be connected to a duct system of which resistance

characteristic, e.g. 7, does not go through the forbidden area. This fan (if not controlled) must be throttled to the minimum pressure loss Δp_s min in accordance with the data tables. If the fan is operated in the forbidden area without being protected by the prescribed method, the motor can be damaged due to electric overloading. If the protection is performed by the prescribed method, the thermo-contacts will activate the protection, and the fan will be stopped. The characteristics give the total pressure Δp_t (Pa). The fan static pressure value Δp_s can be calculated by subtracting the dynamic pressure p_d , which can also be plotted by curve 10 on the graphs, i.e. $\Delta p_s = \Delta p_t - p_d$.

In the "Data Section" of the catalogue, below each RP fan graph across the entire width of the page you can find a table of fan parameters at selected working points. In this table you can read all important aerodynamic and electric parameters for a selected point. Points 5a, 4a, 3a, 2a, and 1a are characterized by zero air flow, i.e. inlet is fully throttled. At these points the fan's motor has the lowest input, and it works with almost no load. Working points 5b, 4b, 3b, 2b, and 1b are characterized by the highest efficiency, and therefore it is advisable to select the effective working point in this area of the curve for the fan's operation; which of course is not compulsory because the motor can permanently work in any part of the characteristic marked by a solid line, i.e. a - c. Working points 5c, 4c, 3c, 2c, and 1c are characterized by maximum load of the motor and the highest air flow, and if the fan has no forbidden area then these points lie on curve 10 (representing p_d value) when the fan works with free inlet and free outlet, i.e. $\Delta p_s = 0$ Pa. As far as the fan's operation, shape of the working characteristic and the fan's state parameters are concerned it makes no difference whether the fan at the particular air flow rate is throttled to the pressure loss Δp_s in the inlet or outlet, or whether the pressure loss Δp_s is divided. A table showing the most important values is situated next to each fan's characteristic in the "Data Section" of this catalogue (Table 2). These values are also listed on the fan's rating plate.

GRAPH 1

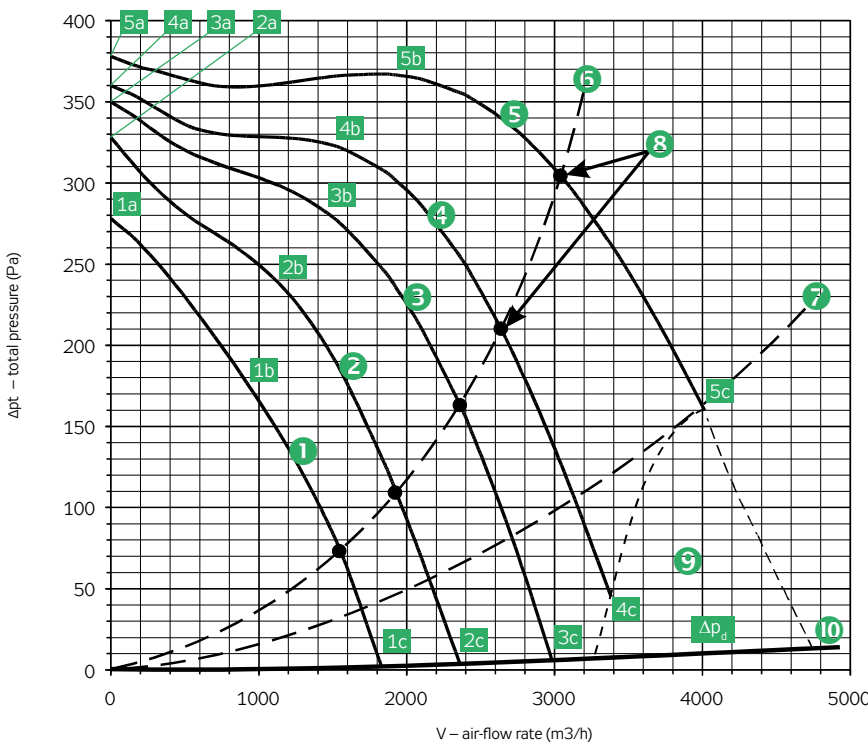

NOISE PARAMETERS

Noise parameters are measured in Remak's special acoustic chamber adjacent to the aerodynamic testing laboratory. The method of measurement enables the acoustic parameters to be measured at the selected fan load in accordance with ČSN EN ISO 3743-2.

The uniform method of evaluation and presentation of noise emissions of air-handling devices has not been constituted yet. Standards in effect allow the use of several methods. The facts mentioned above must always be taken into account when comparing data provided by different manufacturers.

To understand the data contained in this catalogue, refer to the following glossary, the description of used measuring methods, and the assessment outline of the measured data.

Sound Pressure

Sound pressure is the pressure induced by acoustic waves. The waves are a consequence of the noise source's mechanical vibrations, and they are superposed on atmospheric pressure. Sound pressure is directly perceived through the human ear as an effect of acoustic waves at the given observer location. Its value at the measuring site, respectively at the observation site, depends on the distance from the noise source, room size, reflection, acoustic wave absorption capability of insulation materials situated within the source's surrounding, etc. Values of sound pressure [Pa] perceivable by the human ear (from the audibility threshold to the threshold of feeling) lie within the range of several orders, which means that in practice the basic physical unit [Pa] is inapplicable. Therefore, the sound pressure level as a ratio has been implemented in acoustics.

Noise and Noise Level L_p

The sound pressure level, similarly as sound pressure, is a volume criterion at a particular measuring site, respectively observation site. Using this ratio the audible range of acoustic waves (noise, sound, tone, etc.) can be expressed by absolute values around 100 dB, i.e. from 40 dB to 140 dB.

$$L_p = 20 \log \frac{p}{p_0}$$

where p_0 is a reference sound pressure $p_0 = 2 \cdot 10^{-5}$ Pa.

Noise and Noise Level

Noise is a type of acoustic wave. It is characterized by a higher number of non-periodic components and wide spectrum of frequencies. The ear distinguishes not only noise intensity but also perceives its components depending on the frequency, i.e. components with the same sound pressure level but different frequency are perceived differently. Maximum human ear sensitivity ranges from 3500Hz to 4000Hz while this sensitivity drops in higher and lower frequency areas. Each noise component has its own partial sound pressure level. The total sound pressure level in a given location within the surroundings of the noise source is represented by a one-digit value giving the sound volume in this location which can be calculated from the sound pressure levels of its individual frequency components. For practical purposes, noise measure-

ments are performed in accordance with the ČSN EN ISO 3743-2 Standard at frequencies ranging from 45 to 11200Hz. This range is divided into eight parts (octave bands) while the ratio of limiting frequencies is 1:2.

Noise-meters are equipped with transmittance filters corresponding to the respective octave bands, while the value measured in a particular octave band is indicated as the mean frequency of the octave band. The above described differences in human physiological sensitivity to noise components of different frequencies can be simulated by so-called "Correcting Weighting A". Basically, it is a correction of the acoustic pressure level measured value within particular octave bands by correction factors set by the standard (for mean frequencies – refer to Table # 3).

Correction of these measured values is called "Frequency Weighting". Values of the sound pressure in octave bands, corrected by the correction factors for these bands, are expressed as a sound level in octave bands $L_{pA\text{okt}}$. The total sound level L_{pA} can be calculated from the known values of the sound level in octave bands $L_{pA\text{okt}}$

$$L_{pA} = 10 \log \sum_{i=1}^n 10^{\left(\frac{L_{pA\text{okt}i}}{10}\right)}$$

where $L_{pA\text{okt}i}$ is the sound pressure level in the "i" octave band.

Sound Power

As mentioned in the preceding section, the sound pressure, sound pressure level and sound level depend on the actual conditions of measuring (distance from the sound source, room size, reflection, acoustic wave absorption capability of insulation materials situated within the source's surrounding, etc).

Therefore, these values are not suitable to specify the acoustic properties of the device.

The sound power value is used for this purpose; this value specifies the source of acoustic waves, e.g. a fan, independently of the current conditions of the acoustic measurement, and represents the total sound power radiated by the source to its surrounding. The sound power is measured in Watts. The following relationship is valid between sound power and sound pressure

$$W = S \cdot \frac{p^2}{\rho \cdot c}$$

Sound Power Level L_w

Sound power level specifies the source of acoustic waves independently of the environment. Sound power level is defined by the following relationship

$$L_w = 10 \log \frac{W}{W_0}$$

where W_0 is a reference sound power $W_0 = 10^{-12}$ W.

It is necessary to emphasize that the sound power level is not measured but calculated from the measured values of the sound pressure level.

$L_{pA\text{okt}}$ and L_{pA} values are measured with noise sources, for example, fans, using noise meters, then the A-scale sound power level, i.e. L_{wA} can be calculated, which is then used as a value to specify

the acoustic properties of the device in question (fan). In the "Data Section" of this catalogue you can find the LWA value - A-scale sound power level and values L_{WAokt} for individual mean frequencies of octave bands.

Measuring Method Used

It is necessary to stress the fact that the values presented by the manufacturer are measured under conditions specified by the standard used. These values cannot express noise conditions in a particular location or room in which the device, for example, fan, is to be installed. The actual sound level depends on many other factors such as the construction-acoustic properties of the room, respectively space, distance from the noise source, room interior furnishing, etc.

When working on a particular project, first it is necessary to familiarize yourself with the method used by the manufacturer to measure presented parameters, then to analyze the location of the device which is the noise source and make a preliminary calculation of the sound level in the place of movement of persons.

If unfavourable noise conditions are expected, it is necessary to suggest measures to decrease the sound level. Eventually, it is advisable to verify the actual sound level on the site, and if necessary suggest additional measures. The method in accordance with the ČSN EN ISO 3743-2 Standard, i.e. technical methodology for reverberant chambers, was used to determine the noise parameters of fans, i.e. sound power level LWA, presented in this catalogue. In accordance with this Standard, the sound pressure levels in octave bands LPAokt were measured, from which the sound power levels in these octave bands LWAokt were calculated.

In the Data Section of this catalogue you can find, in addition to the characteristic of each fan, the values of sound power level LWA [dB(A)] and LWAokt [dB(A)] for working point 5b on the curve corresponding to nominal voltage, while the sound power presented was calculated from the measurement towards the inlet, outlet and surrounding (Table # 4).

In air-handling equipment, the values of the sound power level will be closer to the values valid for working point 5b.

A schematic drawing of the measured fan position in the room in which the measurement is performed is shown in figure # 4 (towards inlet, outlet, surrounding).

FIGURE 4 – ORIENTATION OF MEASURED FAN

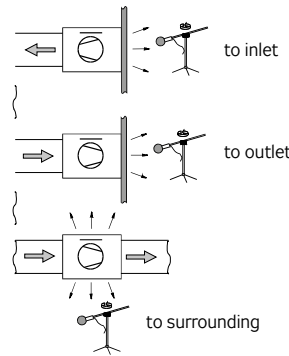

Outline of Noise Attenuation Methods

The fans of the Vento air-handling system are intended for direct installation into duct lines, and thanks to the quality of their design they generally provide very favourable values of noise parameters. In some cases, especially if fans are not located in a separate technical background of the building, and for example are situated in the ceiling, it will be necessary

to consider thoroughly the option of a suitable fan type and its working point which provide the required air flow rate, respectively pressure, at minimum noisiness. Generally, we can say that fan noisiness depends on the following.

- Fan speed, i.e. number of motor's poles (with increasing speed the noisiness is increased significantly)
- Design (backward or forward curved impeller blades and shape of the casing).
- Air flow rate at the given working point.

When considering the noise parameters of the designed equipment, the following procedure is recommended:

- Specify the maximum permissible sound level in the given location.
- The relevant sound power level of the noise source can be calculated from the known, respectively considered data like room size, wall material and its related coefficient of sound absorption, and distance from the noise source.
- If the noise is transmitted via a duct (the fan is situated outside the room) it is necessary to reduce the calculated values of the sound power by the attenuation corresponding to the planned duct line, ventilation grills, attenuators, etc.
- From the catalogue select a suitable fan complying with the calculated value (if the fan is situated directly in the room - maximum value of the sound power, otherwise follow point 3), respectively the fan closest to the given value.
- When selecting the fan, also take into account the option of the working point considering the required sound level. The fan's maximum value of the sound power level is within the area of maximum air flow (i.e. point 5c).
- If no value of sound power listed in this catalogue complies with the requirements, it is possible to consult the manufacturer for values of the sound power of other fan output characteristics, i.e. curves # 4, 3, 2, or 1, or for other working points.
- Apply additional measures to attenuate noise: attenuators (see "Accessories" Catalogue), attenuation by the ceiling, anti-noise insulation, change in the fan's location or duct line, etc.

TABLE 4 – SOUND POWER VALUES

	Inlet	Outlet	Surrounding
Point	5b	5b	5b
Total sound power level LWA [dB(A)]			
L_{WA}	68	74	61
Sound power level LWAokt [dB(A)]			
125 Hz	54	55	44
250 Hz	61	62	53
500 Hz	59	65	54
1000 Hz	62	70	57
2000 Hz	62	68	53
4000 Hz	60	66	49
8000 Hz	53	58	42

Warning: The sound power level indicates the power radiated to the surrounding of the fan, and the sound level in the particular place, respectively in the room, cannot be directly assumed from its values without the appropriate calculation. The sound level values are, due to the influence of the environment (attenuation, directionality, reflection, etc.), numerically significantly lower than the values of the sound power level.

RP

RQ

RO

RE

RF

RPH

EX

TR..

EO..

VO

SUMX

CHV

CHF

HRV

HRZ

PRI

RP

DIMENSIONS, WEIGHTS AND PERFORMANCE

RQ

For important dimensions of RP fans, refer to Figure # 5 and Table # 5. For basic parametrs refer to table # 6.

R0

TABLE 5 – FAN DIMENSIONS

RE

Fan Type	Dimensions in mm							
	A	B	C	D	E	F	G	H
RP 40-20/20..	400	200	420	220	440	240	277	500
RP 50-25/22..	500	250	520	270	540	290	349	530
RP 50-30/25..	500	300	520	320	540	340	399	565
RP 60-30/28..	600	300	620	320	640	340	399	642
RP 60-35/31..	600	350	620	370	640	390	427	720
RP 70-40/35..	700	400	720	420	740	440	477	780
RP 80-50/40..	800	500	820	520	840	540	577	885
RP 90-50/45..	900	500	930	530	960	560	577	985
RP 100-50/45..	1000	500	1030	530	1060	560	577	985

RF

RPH

EX

FIGURE 5 – FAN DIMENSIONAL DIAGRAM

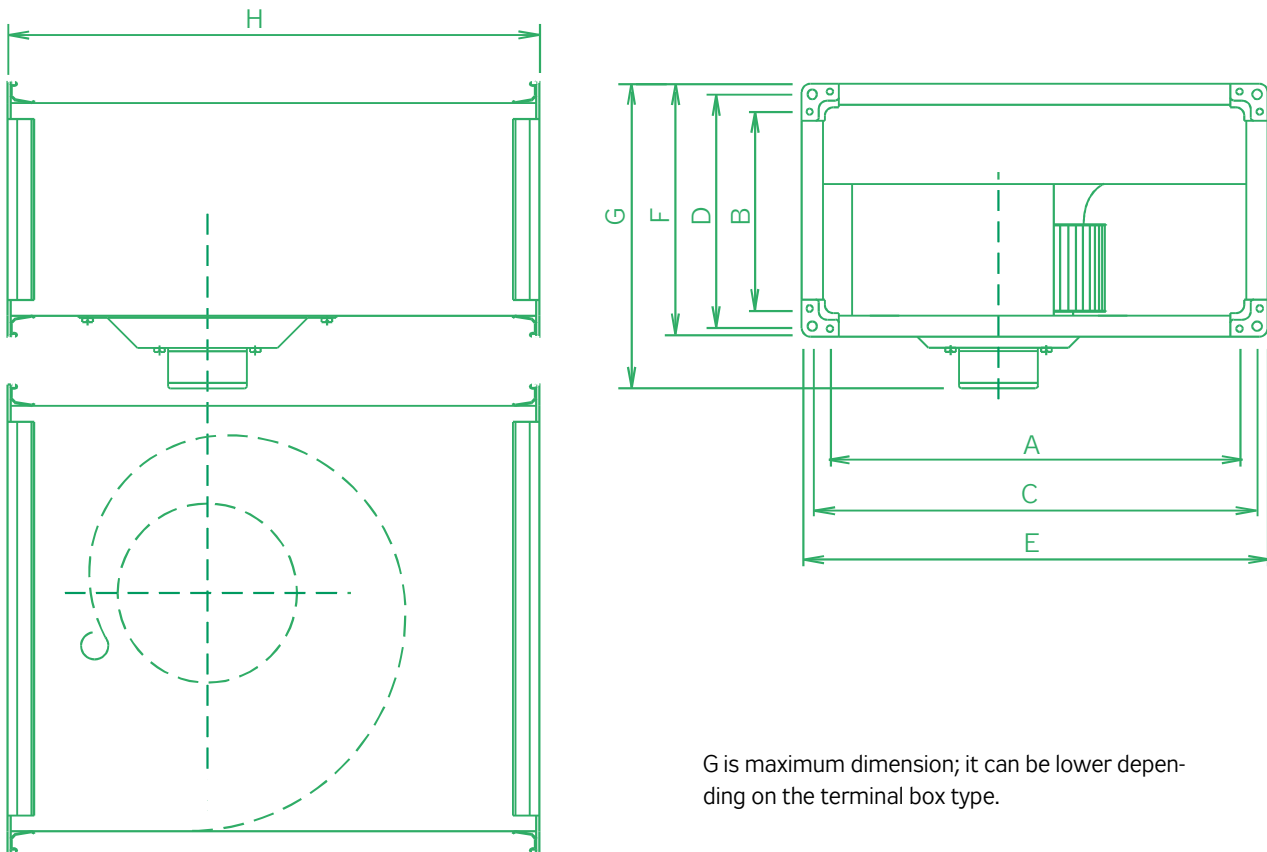

G is maximum dimension; it can be lower depending on the terminal box type.

HRZ

PRI

TABLE 6 – FAN BASIC PARAMETERS AND NOMINAL VALUES

Fan Type	V_{max}	$\Delta p_{t max}$	$\Delta p_{s min}$	n_{nom}	U_{nom}	P_{max}	I_{max}	t_{max}	C	Controller	m	ErP2015	
	m ³ /h	Pa	W	min ⁻¹	V	W	A	°C	µF	type	kg		
SINGLE-PHASE FANS													
RP 40 - 20/20 - 4E	1200	233	0	1420	230	322	1,6	40	5	TRN 2E	13,4	✘	—
RP 50 - 25/22 - 4E	1648	299	55	1420	230	548	2,3	40	8	TRN 4E	18,1	✘	—
RP 50 - 30/25 - 4E	2305	360	0	1380	230	831	3,68	55	14	TRN 4E	22,8	✘	—
RP 60 - 30/28 - 4E	2496	469	152	1400	230	1046	5,1	40	16	TRN 7E	31,7	✘	—
THREE-PHASE FANS													
RP 40 - 20/20 - 4D	1292	236	0	1420	400	291	0,5	70	-	TRN 2D	12,8	✓	η=32.2% (statA) N=44.0 (N44)
RP 50 - 25/22 - 6D	1376	137	0	940	400	222	0,46	55	-	TRN 2D	16	✓	N/A (P1 < 125 W)
RP 50 - 25/22 - 4D	1937	309	0	1440	400	590	1	40	-	TRN 2D	18,1	✘	—
RP 50 - 30/25 - 6D	1811	163	0	940	400	356	0,69	55	-	TRN 2D	18,8	✘	—
RP 50 - 30/25 - 4D	2576	414	0	1450	400	1004	1,97	50	-	TRN 2D	22,5	✘	—
RP 60 - 30/28 - 6D	2531	239	0	960	400	575	1,28	55	-	TRN 2D	25,8	✘	—
RP 60 - 30/28 - 4D	3178	469	0	1450	400	1397	2,38	40	-	TRN 4D	31,5	✓	η=39.2% (statA) N=47.1 (N44)
RP 60 - 35/31 - 6D	3687	281	0	910	400	948	1,86	40	-	TRN 2D	31,2	✘	—
RP 60 - 35/31 - 4D	4512	617	136	1440	400	2464	4,1	40	-	TRN 7 D	38,9	✓	η=38.8% (statA) N=45.9 (N44)
RP 70 - 40/35 - 8D	3669	216	0	670	400	642	1,38	55	-	TRN 2D	44,5	✘	—
RP 70 - 40/35 - 6D	4032	378	151	920	400	1096	2	40	-	TRN 2D	43,5	✓	η=36.6% (statA) N=44.0 (N44)
RP 70 - 40/35 - 4D	5981	806	340	1440	400	3527	6	40	-	TRN 7D	62	✓	η=41.2% (statA) N=46.3 (N44)
RP 80 - 50/40 - 8D	4720	298	0	700	400	1230	2,29	55	-	TRN 4D	57,1	✓	η=37.3% (statA) N=45.6 (N44)
RP 80 - 50/40 - 6D	7357	496	0	960	400	2824	5,11	50	-	TRN 7D	71	✓	η=42.2% (statA) N=48.2 (N44)
RP 80 - 50/40 - 4D	6831	1040	683	1410	400	4919	8,1	40	-	TRN 9D	78	✓	η=44.4% (statA) N=47.9 (N44)
RP 90 - 50/45 - 4D	6558	1498	1014	1260	400	4919	8,3	55	-	TRN 9D	96	✘	—
RP 90 - 50/45 - 6D	9200	667	90	930	400	3780	6,8	55	-	TRN 7D	96	✓	η=42.3% (statA) N=47.3 (N44)
RP 90 - 50/45 - 8D	7810	386	0	690	400	1892	3,88	55	-	TRN 4D	93	✓	η=38.7% (statA) N=45.7 (N44)
RP 100 - 50/45 - 4D	6558	1498	1014	1260	400	4919	8,3	55	-	TRN 9D	96	✘	—
RP 100 - 50/45 - 6D	9200	667	90	930	400	3780	6,8	55	-	TRN 7D	96	✓	η=42.3% (statA) N=47.3 (N44)
RP 100 - 50/45 - 8D	7810	386	0	690	400	1892	3,88	55	-	TRN 4D	93	✓	η=38.7% (statA) N=45.7 (N44)

SYMBOLS USED IN TABLE 6:

- V_{max} maximum air flow rate
- n fan speed measured at the highest efficiency working point (5b), rounded to tens
- U nominal power supply voltage of the motor without control (all values in the table are to this voltage)
- P_{max} electric motor maximal power output
- I_{max} maximum phase current at voltage U (this value must be checked)
- t_{max} maximum permissible transported air temperature at air flow V_{max} .
- C capacitor capacity with single-phase fans
- FM.** frequency inverter
- m** weight of the fan (±10%)

ErP2015

Fan compliance with the requirements of Regulation 2009/125/EC (NOT compliant fans must not be used within EU region)

DATA SECTION

Graph 2 enables quick selection of a suitable fan and alternate comparison of RP fans. Only the highest characteristics of each fan at nominal supply voltage, i.e. without a controller or with a controller set to five stage, are included in this graph. The Data Section of the catalogue contains all important information and measured data of RP fans.

EXAMPLE AND EXPLANATIONS OF FAN DATA

RP 40-20/20-4D

Power supply	Y	3× 400 V	50 Hz
Max. electric input	P_{max}	[W]	291
Max. current (5c)	I_{max}	[A]	0.50
Mean speed	n	[min ⁻¹]	1420
Capacitor	C	[F]	-
Max. working temp.	t_{max}	[°C]	70
Air flow max.	V_{max}	[m ³ /h]	1292
Total pressure max.	$\Delta p_{t,max}$	[Pa]	236
Static pressure min. (5c)	$\Delta p_{s,min}$	[Pa]	0
Weight	m	[kg]	12.8
Five-stage controller	type	TRN 2D	
Protecting relay	type	STD	

The meaning of individual lines is as follows:

- 1 Value of nominal power supply voltage
- 2 Maximum power input of the motor at working point 5c.
- 3 Maximum current at nominal voltage at working point 5c.
- 4 Mean speed, rounded to tens, measured at working point 5b.
- 5 Capacitor capacity with single-phase fans.
- 6 Maximum permissible transported air temperature.
- 7 Maximum air flow at working point 5c.
- 8 Maximum total pressure between points 5a–5c
- 9 Minimum permissible static pressure at point 5c.
- 10 Total weight of the fan.
- 11 Recommended fan output controller.
- 12 Recommended protecting relay of the fan without controller and control unit.

GRAPH 2 – RP FAN CHARACTERISTICS QUICK SELECTION

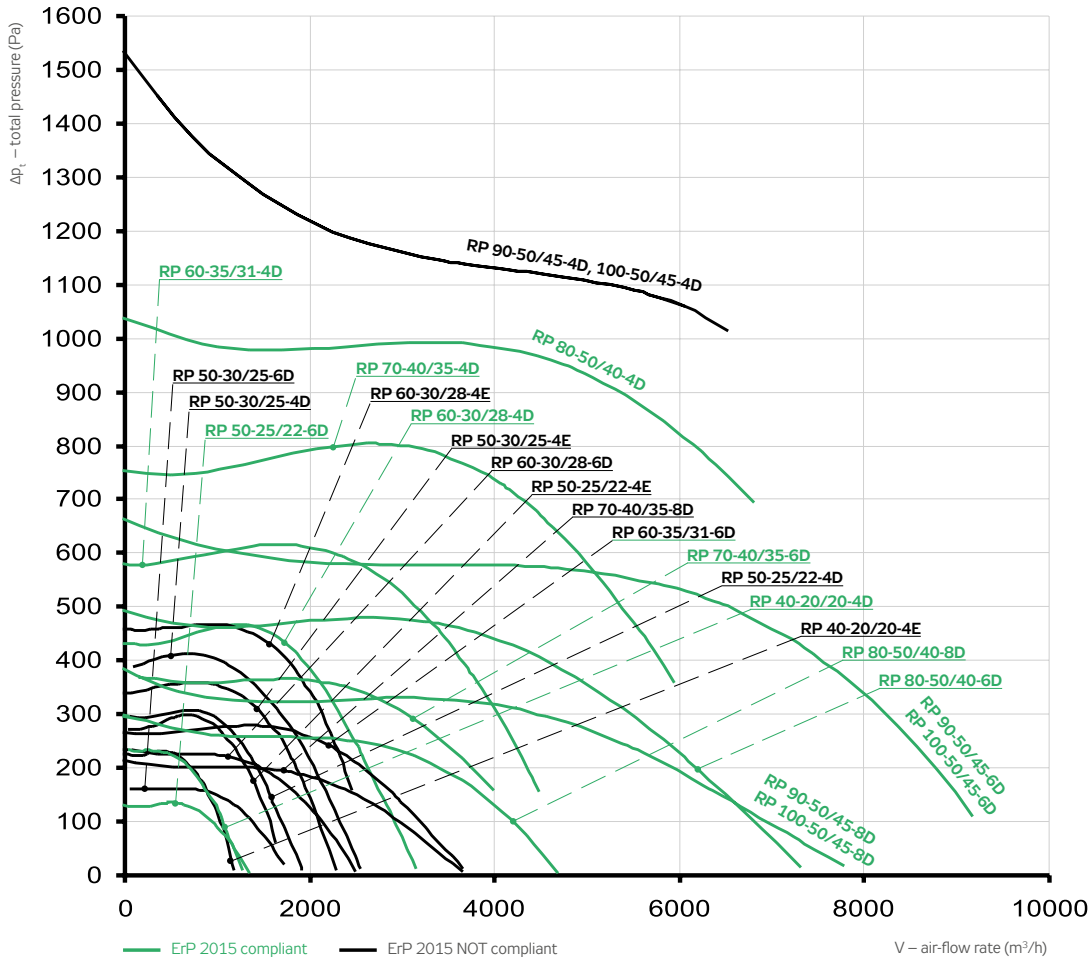

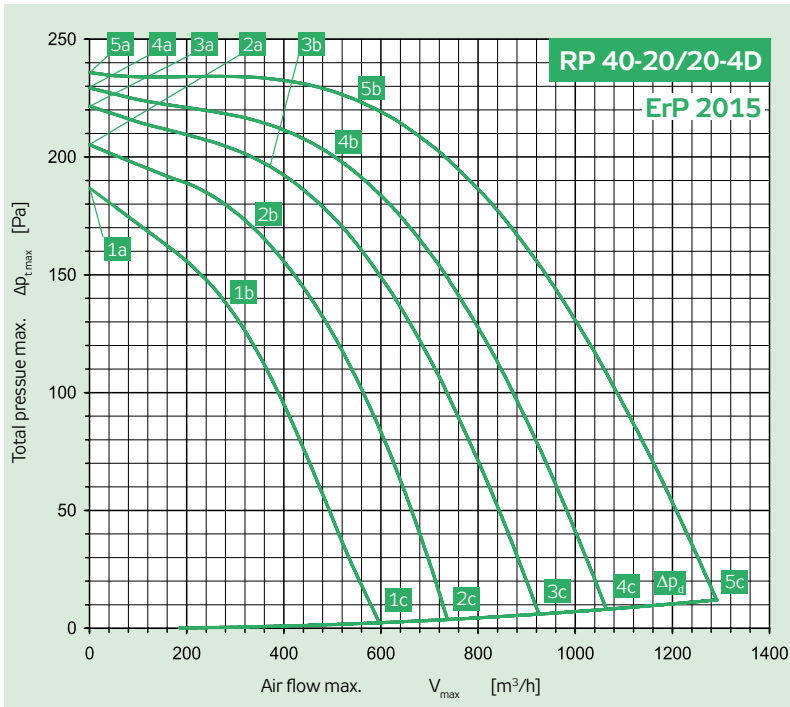

Power supply	Y	3 × 400 V	50 Hz
Max. electric input	P_{max}	[W]	291
Max. current (5c)	I_{max}	[A]	0.50
Mean speed	n	[min ⁻¹]	1420
Capacitor	C	[F]	-
Max. working temp.	t_{max}	[°C]	70
Air flow max.	V_{max}	[m ³ /h]	1292
Total pressure max.	$\Delta p_{t,max}$	[Pa]	236
Static pressure min. (5c)	$\Delta p_{s,min}$	[Pa]	0
Weight	m	[kg]	12.8
Five-stage controller	type		TRN 2D
Protecting relay	type		STD

	Inlet	Outlet	Surrounding
Point	5b	5b	5b
Total sound power level LWA [dB(A)]			
L_{WA}	68	74	61
Sound power level LWAokt [dB(A)]			
125 Hz	54	55	44
250 Hz	61	62	53
500 Hz	59	65	54
1000 Hz	62	70	57
2000 Hz	62	68	53
4000 Hz	60	66	49
8000 Hz	53	58	42

Parameters in selected working points	5a	5b	5c	4a	4b	4c	3a	3b	3c	2a	2b	2c	1a	1b	1c
Voltage U [V]	400			280			230			180			140		
Current I [A]	0.30	0.32	0.50	0.19	0.26	0.50	0.17	0.22	0.47	0.17	0.22	0.43	0.15	0.22	0.37
Input power P [W]	71	125	291	49	98	215	41	71	170	41	60	120	31	49	81
Speed n [min ⁻¹]	1468	1418	1232	1438	1340	1011	1410	1319	892	1329	1226	734	1271	1094	590
Air flow V [m ³ /h]	0	561	1292	0	515	1061	0	383	923	0	345	734	0	296	592
Static pressure Δp_s [Pa]	236	222	0	229	198	0	222	193	0	205	166	0	187	132	0
Total pressure Δp_t [Pa]	236	224	12	229	200	8	222	194	6	205	167	4	187	133	2

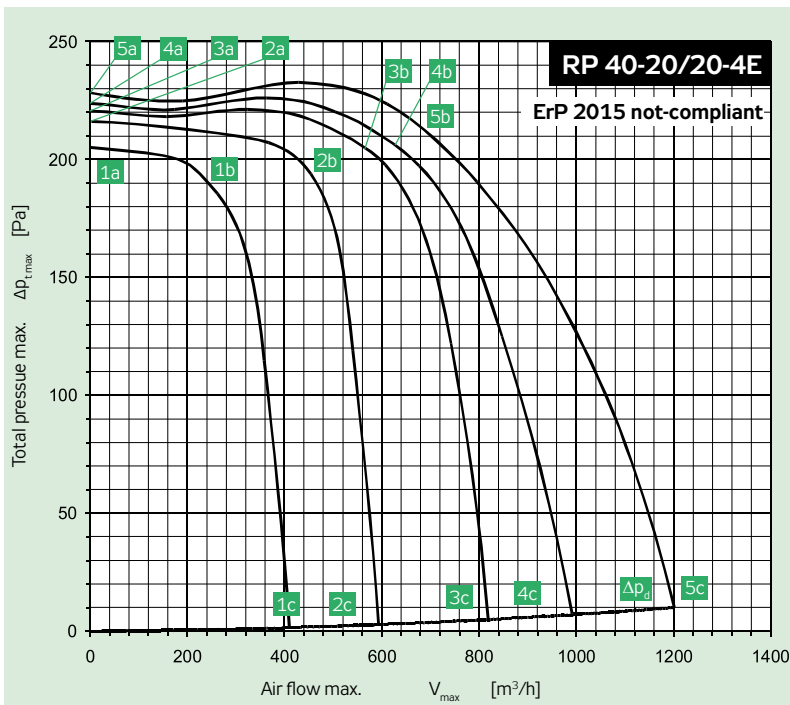

Power supply		230 V	50 Hz
Max. electric input	P_{max}	[W]	322
Max. current (5c)	I_{max}	[A]	1.60
Mean speed	n	[min ⁻¹]	1420
Capacitor	C	[F]	5
Max. working temp.	t_{max}	[°C]	40
Air flow max.	V_{max}	[m ³ /h]	1200
Total pressure max.	$\Delta p_{t,max}$	[Pa]	233
Static pressure min. (5c)	$\Delta p_{s,min}$	[Pa]	0
Weight	m	[kg]	13.4
Five-stage controller	type		TRN 2E
Protecting relay	type		STE

	Inlet	Outlet	Surrounding
Point	5b	5b	5b
Total sound power level LWA [dB(A)]			
L_{WA}	71	78	66
Sound power level LWAokt [dB(A)]			
125 Hz	57	56	50
250 Hz	66	71	63
500 Hz	63	68	58
1000 Hz	63	73	59
2000 Hz	64	71	55
4000 Hz	62	69	50
8000 Hz	53	61	43

Parameters in selected working points	5a	5b	5c	4a	4b	4c	3a	3b	3c	2a	2b	2c	1a	1b	1c
Voltage U [V]	230			180			160			130			105		
Current I [A]	0.99	1.08	1.6	0.56	0.81	1.58	0.49	0.78	1.46	0.46	0.72	1.17	0.48	0.57	0.95
Input power P [W]	144	197	322	91	141	237	77	122	189	62	92	122	49	56	75
Speed n [min ⁻¹]	1388	1416	1244	1459	1387	885	1449	1363	649	1428	1319	520	1391	1337	399
Air flow V [m ³ /h]	0	692	1200	0	629	851	0	576	607	0	459	470	0	254	358
Static pressure Δp_s [Pa]	228	210	0	224	204	0	221	200	0	216	190	0	205	187	0
Total pressure Δp_t [Pa]	228	213	10	224	207	5	221	202	3	216	191	2	205	187	1

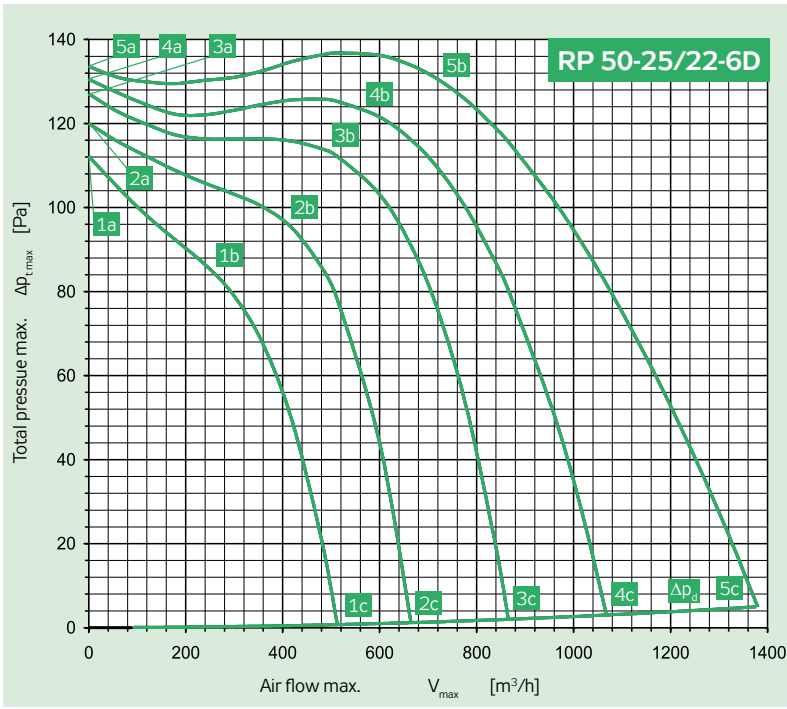

Power supply	Y	3 × 400 V	50 Hz
Max. electric input	P_{max}	[W]	222
Max. current (5c)	I_{max}	[A]	0.46
Mean speed	n	[min ⁻¹]	940
Capacitor	C	[F]	-
Max. working temp.	t_{max}	[°C]	55
Air flow max.	V_{max}	[m ³ /h]	1376
Total pressure max.	$\Delta p_{t,max}$	[Pa]	137
Static pressure min. (5c)	$\Delta p_{s,min}$	[Pa]	0
Weight	m	[kg]	16
Five-stage controller	type		TRN 2D
Protecting relay	type		STD

	Inlet	Outlet	Surrounding
Point	5b	5b	5b
Total sound power level LWA [dB(A)]			
L_{WA}	66	66	57
Sound power level LWAokt [dB(A)]			
125 Hz	58	52	47
250 Hz	62	57	51
500 Hz	57	59	52
1000 Hz	57	60	51
2000 Hz	57	59	45
4000 Hz	54	57	42
8000 Hz	44	48	41

Parameters in selected working points	5a	5b	5c	4a	4b	4c	3a	3b	3c	2a	2b	2c	1a	1b	1c
Voltage U [V]	400			280			230			180			140		
Current I [A]	0.30	0.33	0.46	0.20	0.24	0.42	0.17	0.21	0.38	0.15	0.20	0.33	0.14	0.17	0.27
Input power P [W]	62	110	222	36	68	151	31	56	111	26	44	73	22	30	45
Speed n [min ⁻¹]	986	943	825	971	912	650	954	878	548	921	823	420	873	795	347
Air flow V [m ³ /h]	0	735	1376	0	571	1064	0	490	864	0	399	665	0	259	511
Static pressure Δp_s [Pa]	134	130	0	131	123	0	127	113	0	120	96	0	112	85	0
Total pressure Δp_t [Pa]	134	132	5	131	124	3	127	114	2	120	96	1	112	85	1

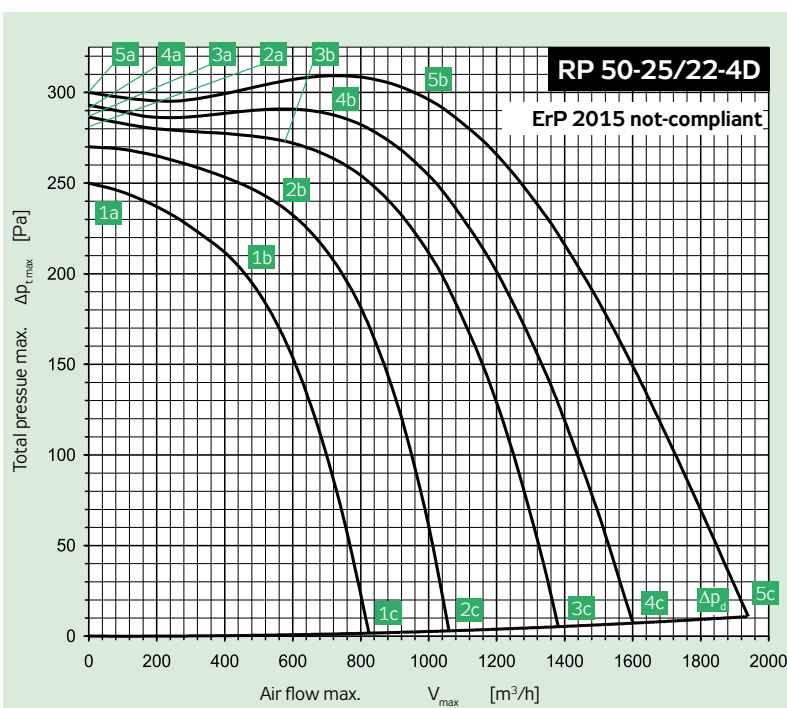

Power supply	Y	3 × 400 V	50 Hz
Max. electric input	P_{max}	[W]	590
Max. current (5c)	I_{max}	[A]	1.00
Mean speed	n	[min ⁻¹]	1440
Capacitor	C	[F]	-
Max. working temp.	t_{max}	[°C]	40
Air flow max.	V_{max}	[m ³ /h]	1937
Total pressure max.	$\Delta p_{t,max}$	[Pa]	309
Static pressure min. (5c)	$\Delta p_{s,min}$	[Pa]	0
Weight	m	[kg]	18.1
Five-stage controller	type		TRN 2D
Protecting relay	type		STD

	Inlet	Outlet	Surrounding
Point	5b	5b	5b
Total sound power level LWA [dB(A)]			
L_{WA}	72	78	64
Sound power level LWAokt [dB(A)]			
125 Hz	65	64	54
250 Hz	66	70	58
500 Hz	62	71	58
1000 Hz	62	73	57
2000 Hz	65	71	56
4000 Hz	62	69	52
8000 Hz	53	61	44

Parameters in selected working points	5a	5b	5c	4a	4b	4c	3a	3b	3c	2a	2b	2c	1a	1b	1c
Voltage U [V]	400			280			230			180			140		
Current I [A]	0.58	0.63	1.00	0.34	0.46	1.07	0.28	0.40	1.00	0.26	0.45	0.97	0.27	0.45	0.84
Input power P [W]	119	249	590	85	174	478	67	131	379	60	121	251	54	96	167
Speed n [min ⁻¹]	1485	1439	1306	1463	1400	1085	1448	1377	948	1409	1284	744	1353	1189	585
Air flow V [m ³ /h]	0	951	1937	0	715	1605	0	592	1379	0	567	1060	0	452	825
Static pressure Δp_s [Pa]	300	300	0	293	284	0	286	272	0	270	234	0	250	198	0
Total pressure Δp_t [Pa]	300	303	11	293	285	7	286	273	5	270	235	3	250	199	2

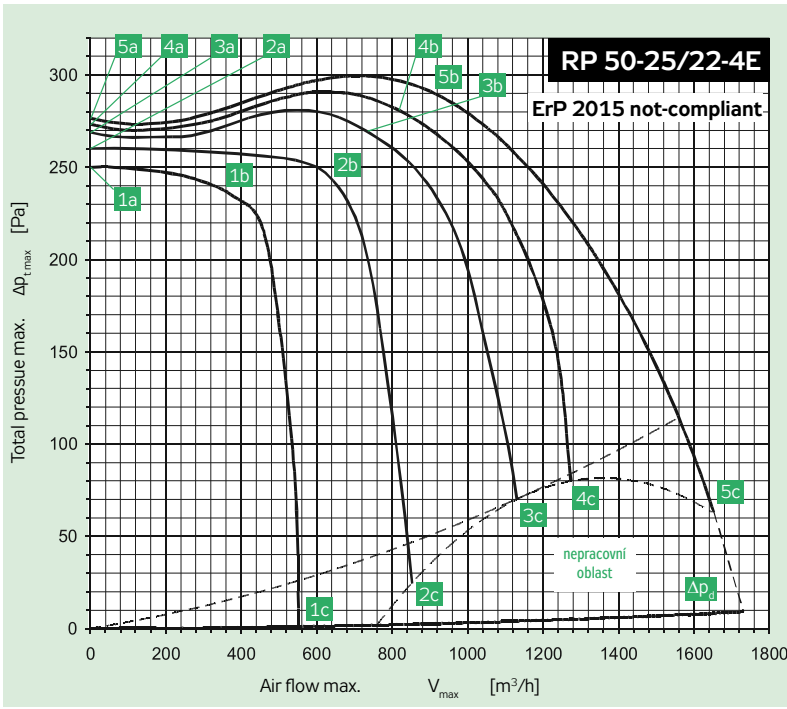

Power supply		230 V	50 Hz
Max. electric input	P_{max}	[W]	499
Max. current (5c)	I_{max}	[A]	2.30
Mean speed	n	[min ⁻¹]	1420
Capacitor	C	[F]	8
Max. working temp.	t_{max}	[°C]	40
Air flow max.	V_{max}	[m ³ /h]	1648
Total pressure max.	$\Delta p_{t,max}$	[Pa]	299
Static pressure min. (5c)	$\Delta p_{s,min}$	[Pa]	55
Weight	m	[kg]	18.1
Five-stage controller	type		TRN 4E
Protecting relay	type		STE

	Inlet	Outlet	Surrounding
Point	5b	5b	5b
Total sound power level LWA [dB(A)]			
L_{WA}	73	77	65
Sound power level LWAokt [dB(A)]			
125 Hz	65	61	57
250 Hz	67	67	59
500 Hz	61	68	57
1000 Hz	64	72	58
2000 Hz	66	70	57
4000 Hz	64	69	52
8000 Hz	56	61	44

Parameters in selected working points	5a	5b	5c	4a	4b	4c	3a	3b	3c	2a	2b	2c	1a	1b	1c
Voltage U [V]		230			180			160			130			105	
Current I [A]	1.07	1.33	2.30	0.69	1.15	2.25	0.66	1.11	2.20	0.70	1.11	2.01	0.66	0.90	1.64
Input power P [W]	181	275	499	124	211	381	108	180	319	95	147	225	73	97	146
Speed n [min ⁻¹]	1471	1419	1259	1466	1398	1081	1456	1373	881	1426	1318	541	1399	1316	416
Air flow V [m ³ /h]	0	914	1648	0	818	1275	0	728	1128	0	614	845	0	350	557
Static pressure Δp_s [Pa]	277	288	55	273	280	75	269	270	70	260	244	25	250	231	0
Total pressure Δp_t [Pa]	277	290	63	273	282	80	269	272	73	260	245	27	250	231	1

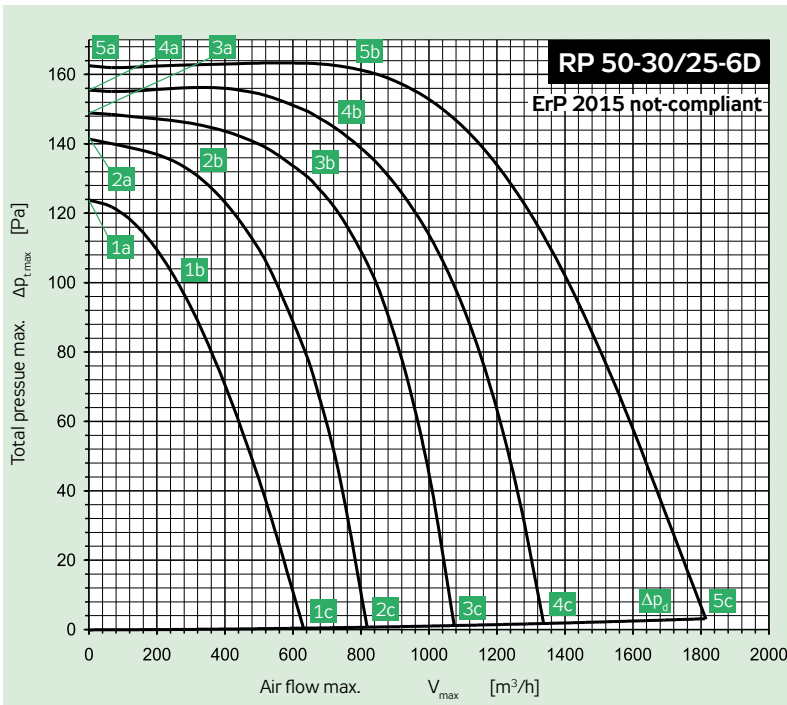

Power supply	Y	3 × 400 V	50 Hz
Max. electric input	P_{max}	[W]	356
Max. current (5c)	I_{max}	[A]	0.69
Mean speed	n	[min ⁻¹]	940
Capacitor	C	[F]	-
Max. working temp.	t_{max}	[°C]	50
Air flow max.	V_{max}	[m ³ /h]	1811
Total pressure max.	$\Delta p_{t,max}$	[Pa]	163
Static pressure min. (5c)	$\Delta p_{s,min}$	[Pa]	0
Weight	m	[kg]	18.8
Five-stage controller	type		TRN 2D
Protecting relay	type		STD

	Inlet	Outlet	Surrounding
Point	5b	5b	5b
Total sound power level LWA [dB(A)]			
L_{WA}	65	68	58
Sound power level LWAokt [dB(A)]			
125 Hz	62	55	45
250 Hz	54	56	51
500 Hz	54	61	52
1000 Hz	55	63	54
2000 Hz	57	62	47
4000 Hz	54	59	43
8000 Hz	43	48	40

Parameters in selected working points	5a	5b	5c	4a	4b	4c	3a	3b	3c	2a	2b	2c	1a	1b	1c
Voltage U [V]		400			280			230			180			140	
Current I [A]	0.42	0.45	0.69	0.30	0.36	0.65	0.25	0.33	0.57	0.21	0.25	0.47	0.21	0.24	0.38
Input power P [W]	76	133	356	49	104	223	42	88	157	37	51	98	33	41	59
Speed n [min ⁻¹]	977	943	770	959	891	593	942	844	481	912	861	377	840	772	306
Air flow V [m ³ /h]	0	776	1811	0	731	1334	0	652	1073	0	324	817	0	259	627
Static pressure Δp_s [Pa]	163	160	0	156	144	0	149	129	0	141	132	0	124	103	0
Total pressure Δp_t [Pa]	163	161	3	156	145	2	149	129	1	141	132	1	124	103	0

RP
RQ
RO
RE
RF
RPH
EX
TR.
EO..
VO
SUMX
CHV
CHF
HRV
HRZ
PRI

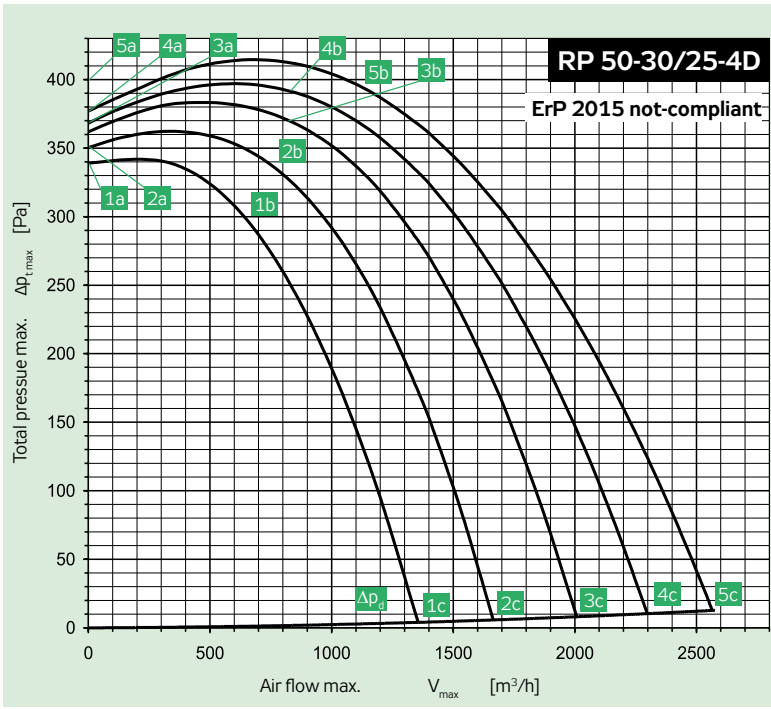

Power supply	Y	3 × 400 V	50 Hz
Max. electric input	P _{max}	[W]	1004
Max. current (5c)	I _{max}	[A]	1.97
Mean speed	n	[min ⁻¹]	1450
Capacitor	C	[F]	-
Max. working temp.	t _{max}	[°C]	50
Air flow max.	V _{max}	[m ³ /h]	2576
Total pressure max.	Δ p _{t,max}	[Pa]	414
Static pressure min. (5c)	Δ p _{s,min}	[Pa]	0
Weight	m	[kg]	22.5
Five-stage controller	type		TRN 2D
Protecting relay	type		STD

	Inlet	Outlet	Surrounding
Point	5b	5b	5b
Total sound power level LWA [dB(A)]			
L _{WA}	74	79	69
Sound power level LWAokt [dB(A)]			
125 Hz	67	63	56
250 Hz	65	67	59
500 Hz	63	71	61
1000 Hz	67	74	65
2000 Hz	68	73	62
4000 Hz	65	71	57
8000 Hz	57	61	49

Parameters in selected working points	5a	5b	5c	4a	4b	4c	3a	3b	3c	2a	2b	2c	1a	1b	1c
Voltage U [V]	400			280			230			180			140		
Current I [A]	1.30	1.37	1.97	0.72	0.88	1.92	0.60	0.89	2.10	0.52	0.90	1.99	0.49	0.93	1.77
Input power P [W]	223	441	1004	133	271	803	120	268	700	114	246	519	97	205	358
Speed n [min ⁻¹]	1479	1454	1362	1469	1417	1216	1457	1387	1096	1434	1336	904	1390	1277	731
Air flow V [m ³ /h]	0	1110	2576	0	804	2306	0	828	2011	0	774	1666	0	679	1363
Static pressure Δp _s [Pa]	377	391	0	368	393	0	362	374	0	350	337	0	339	292	0
Total pressure Δp _t [Pa]	377	394	13	368	395	10	362	375	8	350	339	6	339	293	4

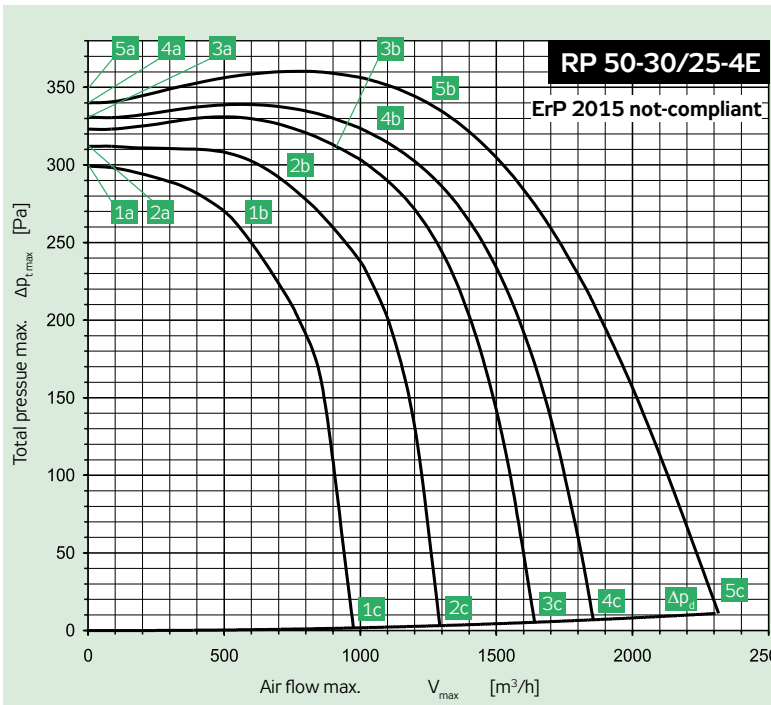

Power supply		230 V	50 Hz
Max. electric input	P _{max}	[W]	831
Max. current (5c)	I _{max}	[A]	3.68
Mean speed	n	[min ⁻¹]	1380
Capacitor	C	[F]	14
Max. working temp.	t _{max}	[°C]	50
Air flow max.	V _{max}	[m ³ /h]	2305
Total pressure max.	Δ p _{t,max}	[Pa]	360
Static pressure min. (5c)	Δ p _{s,min}	[Pa]	0
Weight	m	[kg]	22.8
Five-stage controller	type		TRN 4E
Protecting relay	type		STE

	Inlet	Outlet	Surrounding
Point	5b	5b	5b
Total sound power level LWA [dB(A)]			
L _{WA}	75	81	68
Sound power level LWAokt [dB(A)]			
125 Hz	66	64	57
250 Hz	66	67	60
500 Hz	65	73	61
1000 Hz	68	77	64
2000 Hz	69	74	59
4000 Hz	67	72	55
8000 Hz	58	62	46

Parameters in selected working points	5a	5b	5c	4a	4b	4c	3a	3b	3c	2a	2b	2c	1a	1b	1c
Voltage U [V]	230			180			160			130			105		
Current I [A]	1.23	1.94	3.68	1.11	1.87	3.64	1.09	1.76	3.51	1.02	1.62	3.07	0.98	1.55	2.64
Input power P [W]	270	444	831	199	339	632	174	286	539	135	215	381	107	167	262
Speed n [min ⁻¹]	1453	1382	1162	1436	1336	943	1424	1319	830	1402	1276	664	1368	1205	508
Air flow V [m ³ /h]	0	1230	2305	0	1041	1854	0	915	1638	0	722	1289	0	585	974
Static pressure Δp _s [Pa]	340	338	0	331	320	0	323	308	0	312	286	0	299	253	0
Total pressure Δp _t [Pa]	340	341	11	331	322	7	323	310	5	312	287	3	299	254	2

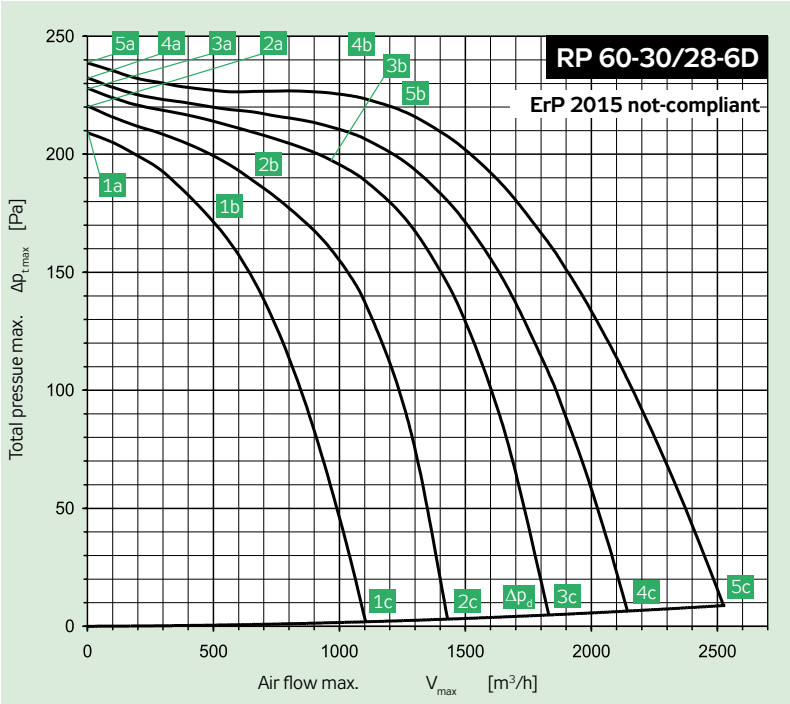

Power supply	Y	3 × 400 V	50 Hz
Max. electric input	P _{max}	[W]	575
Max. current (5c)	I _{max}	[A]	1.28
Mean speed	n	[min ⁻¹]	960
Capacitor	C	[F]	-
Max. working temp.	t _{max}	[°C]	55
Air flow max.	V _{max}	[m ³ /h]	2531
Total pressure max.	Δ p _{t,max}	[Pa]	239
Static pressure min. (5c)	Δ p _{s,min}	[Pa]	0
Weight	m	[kg]	25.8
Five-stage controller	type		TRN 2D
Protecting relay	type		STD

	Inlet	Outlet	Surrounding
Point	5b	5b	5b
Total sound power level LWA [dB(A)]			
L _{WA}	69	73	63
Sound power level LWAokt [dB(A)]			
125 Hz	64	61	57
250 Hz	60	62	56
500 Hz	62	68	57
1000 Hz	60	68	56
2000 Hz	60	65	52
4000 Hz	59	64	47
8000 Hz	48	53	41

Parameters in selected working points	5a	5b	5c	4a	4b	4c	3a	3b	3c	2a	2b	2c	1a	1b	1c
Voltage U [V]	400			280			230			180			140		
Current I [A]	0.30	0.32	0.50	0.19	0.26	0.50	0.17	0.22	0.47	0.17	0.22	0.43	0.15	0.22	0.37
Input power P [W]	71	125	291	49	98	215	41	71	170	41	60	120	31	49	81
Speed n [min ⁻¹]	1468	1418	1232	1438	1340	1011	1410	1319	892	1329	1226	734	1271	1094	590
Air flow V [m ³ /h]	0	561	1292	0	515	1061	0	383	923	0	345	734	0	296	592
Static pressure Δp _s [Pa]	236	222	0	229	198	0	222	193	0	205	166	0	187	132	0
Total pressure Δp _t [Pa]	236	224	12	229	200	8	222	194	6	205	167	4	187	133	2

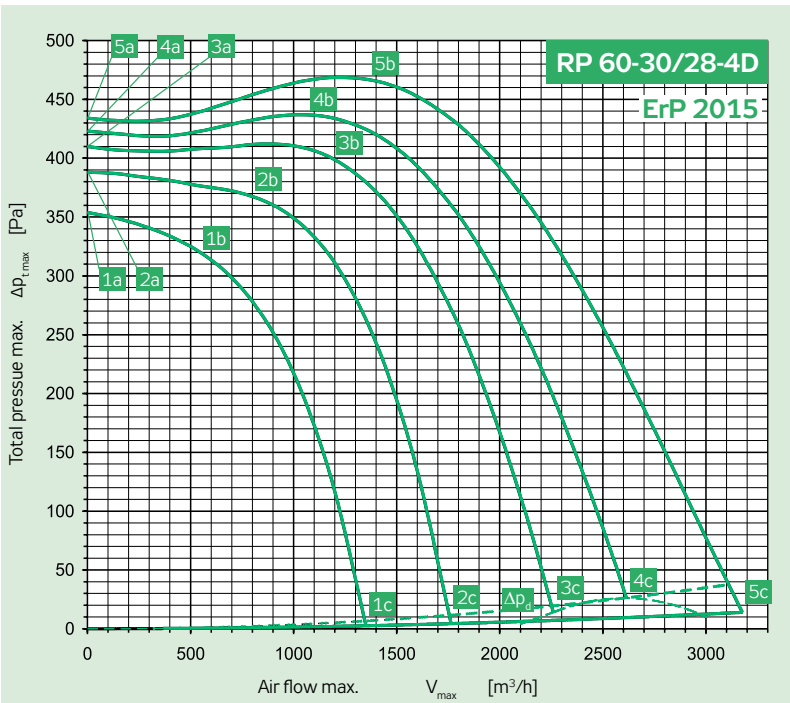

Power supply	Y	3 × 400 V	50 Hz
Max. electric input	P _{max}	[W]	1397
Max. current (5c)	I _{max}	[A]	2.38
Mean speed	n	[min ⁻¹]	1450
Capacitor	C	[F]	-
Max. working temp.	t _{max}	[°C]	40
Air flow max.	V _{max}	[m ³ /h]	3178
Total pressure max.	Δ p _{t,max}	[Pa]	469
Static pressure min. (5c)	Δ p _{s,min}	[Pa]	0
Weight	m	[kg]	31.5
Five-stage controller	type		TRN 4 D
Protecting relay	type		STD

	Inlet	Outlet	Surrounding
Point	5b	5b	5b
Total sound power level LWA [dB(A)]			
L _{WA}	78	83	70
Sound power level LWAokt [dB(A)]			
125 Hz	70	70	59
250 Hz	68	70	61
500 Hz	67	75	62
1000 Hz	72	78	66
2000 Hz	72	77	62
4000 Hz	69	75	58
8000 Hz	61	65	50

Parameters in selected working points	5a	5b	5c	4a	4b	4c	3a	3b	3c	2a	2b	2c	1a	1b	1c
Voltage U [V]	400			280			230			180			140		
Current I [A]	1.04	1.20	2.38	0.69	0.98	2.60	0.62	1.07	2.60	0.62	1.02	2.43	0.66	0.94	2.06
Input power P [W]	267	512	1397	201	380	1088	181	372	870	161	285	612	142	206	393
Speed n [min ⁻¹]	1483	1448	1307	1461	1409	1105	1438	1346	938	1404	1301	736	1344	1246	568
Air flow V [m ³ /h]	0	1330	3178	0	1083	2614	0	1162	2260	0	850	1766	0	552	1348
Static pressure Δp _s [Pa]	434	467	0	423	433	16	410	401	7	388	361	0	354	318	0
Total pressure Δp _t [Pa]	434	469	14	423	435	26	410	403	14	388	362	4	354	318	3

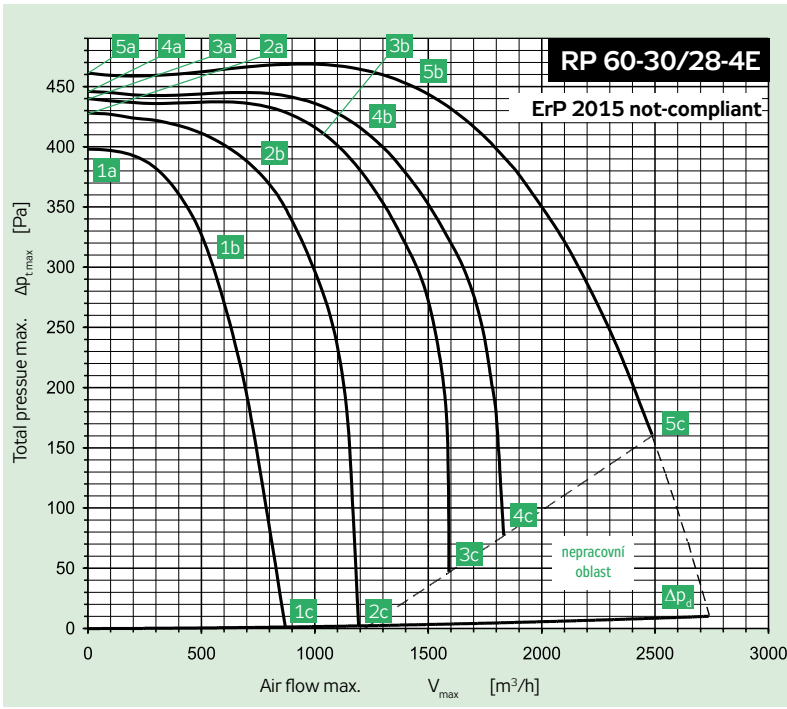

Parameters in selected working points	5a	5b	5c	4a	4b	4c	3a	3b	3c	2a	2b	2c	1a	1b	1c
Voltage U [V]	230			180			160			130			105		
Current I [A]	2.08	2.96	5.10	1.42	2.66	5.10	1.43	2.52	5.10	1.40	2.38	4.30	1.49	2.43	3.48
Input power P [W]	345	603	1046	247	452	775	225	389	681	185	294	457	158	234	294
Speed n [min ⁻¹]	1465	1400	1237	1453	1353	898	1446	1345	760	1422	1288	499	1372	1157	385
Air flow V [m ³ /h]	0	1465	2496	0	1222	1834	0	1054	1592	0	786	1218	0	584	882
Static pressure Δp _s [Pa]	461	439	152	446	411	72	440	406	43	428	369	0	398	294	0
Total pressure Δp _t [Pa]	461	442	161	446	413	77	440	408	47	428	370	2	398	294	1

Power supply		230 V	50 Hz
Max. electric input	P _{max}	[W]	1046
Max. current (5c)	I _{max}	[A]	5.10
Mean speed	n	[min ⁻¹]	1400
Capacitor	C	[F]	16
Max. working temp.	t _{max}	[°C]	40
Air flow max.	V _{max}	[m ³ /h]	2496
Total pressure max.	Δp _{t max}	[Pa]	469
Static pressure min. (5c)	Δp _{s min}	[Pa]	152
Weight	m	[kg]	31.7
Five-stage controller	type		TRN 7E
Protecting relay	type		STE

	Inlet	Outlet	Surrounding
Point	5b	5b	5b
Total sound power level LWA [dB(A)]			
L _{WA}	77	83	70
Sound power level LWAokt [dB(A)]			
125 Hz	71	70	61
250 Hz	68	72	64
500 Hz	67	75	63
1000 Hz	69	78	64
2000 Hz	71	77	61
4000 Hz	67	74	57
8000 Hz	59	65	47

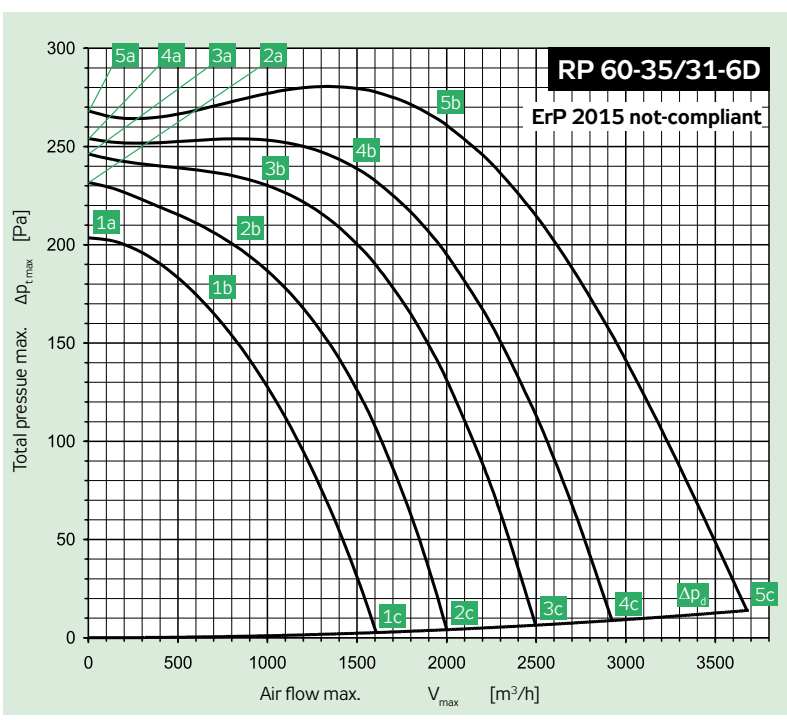

Parameters in selected working points	5a	5b	5c	4a	4b	4c	3a	3b	3c	2a	2b	2c	1a	1b	1c
Voltage U [V]	400			280			230			180			140		
Current I [A]	1.30	1.36	1.86	0.68	0.87	1.56	0.56	0.68	1.42	0.46	0.64	1.23	0.44	0.60	1.02
Input power P [W]	226	476	948	120	287	606	109	186	457	87	152	302	69	110	194
Speed n [min ⁻¹]	977	908	754	959	866	609	940	878	532	909	808	429	866	755	355
Air flow V [m ³ /h]	0	1946	3687	0	1470	2932	0	930	2494	0	873	2000	0	688	1603
Static pressure Δp _s [Pa]	268	260	0	254	235	0	246	233	0	232	198	0	204	169	0
Total pressure Δp _t [Pa]	268	264	14	254	237	9	246	234	6	232	199	4	204	169	3

Power supply	Y	3 × 400 V	50 Hz
Max. electric input	P _{max}	[W]	948
Max. current (5c)	I _{max}	[A]	1.86
Mean speed	n	[min ⁻¹]	910
Capacitor	C	[F]	-
Max. working temp.	t _{max}	[°C]	40
Air flow max.	V _{max}	[m ³ /h]	3687
Total pressure max.	Δp _{t max}	[Pa]	281
Static pressure min. (5c)	Δp _{s min}	[Pa]	0
Weight	m	[kg]	31.2
Five-stage controller	type		TRN 2D
Protecting relay	type		STD

	Inlet	Outlet	Surrounding
Point	5b	5b	5b
Total sound power level LWA [dB(A)]			
L _{WA}	70	75	64
Sound power level LWAokt [dB(A)]			
125 Hz	65	62	58
250 Hz	60	65	56
500 Hz	61	69	58
1000 Hz	62	69	58
2000 Hz	62	68	52
4000 Hz	61	67	49
8000 Hz	49	54	41

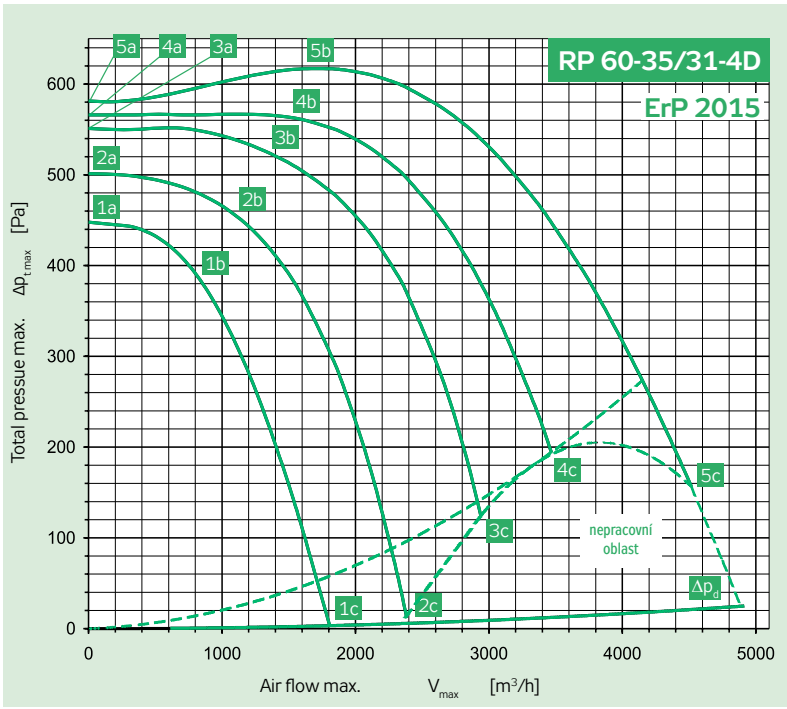

Power supply	Y	3× 400 V	50 Hz
Max. electric input	P_{max}	[W]	2464
Max. current (5c)	I_{max}	[A]	4.10
Mean speed	n	[min ⁻¹]	1440
Capacitor	C	[F]	-
Max. working temp.	t_{max}	[°C]	40
Air flow max.	V_{max}	[m ³ /h]	4512
Total pressure max.	$\Delta p_{t,max}$	[Pa]	617
Static pressure min. (5c)	$\Delta p_{s,min}$	[Pa]	136
Weight	m	[kg]	38.9
Five-stage controller	type		TRN 7D
Protecting relay	type		STD

	Inlet	Outlet	Surrounding
Point	5b	5b	5b
Total sound power level LWA [dB(A)]			
L_{WA}	78	83	72
Sound power level LWAokt [dB(A)]			
125 Hz	72	69	67
250 Hz	67	70	61
500 Hz	67	74	64
1000 Hz	71	78	66
2000 Hz	71	77	63
4000 Hz	69	76	61
8000 Hz	60	66	52

Parameters in selected working points	5a	5b	5c	4a	4b	4c	3a	3b	3c	2a	2b	2c	1a	1b	1c
Voltage U [V]	400			280			230			180			140		
Current I [A]	1.41	1.72	4.10	1.04	1.62	4.10	1.06	1.62	4.10	1.07	1.73	4.10	1.13	1.77	3.39
Input power P [W]	503	832	2464	351	666	1730	343	563	1374	295	484	1007	252	382	629
Speed n [min ⁻¹]	1474	1440	1252	1445	1383	1083	1418	1346	912	1381	1270	603	1321	1164	461
Air flow V [m ³ /h]	0	1754	4512	0	1533	3498	0	1324	2937	0	1064	2372	0	852	1808
Static pressure Δp_s [Pa]	581	614	136	566	561	182	551	524	115	501	460	6	448	383	0
Total pressure Δp_t [Pa]	581	617	157	566	563	194	551	526	124	501	461	12	448	384	3

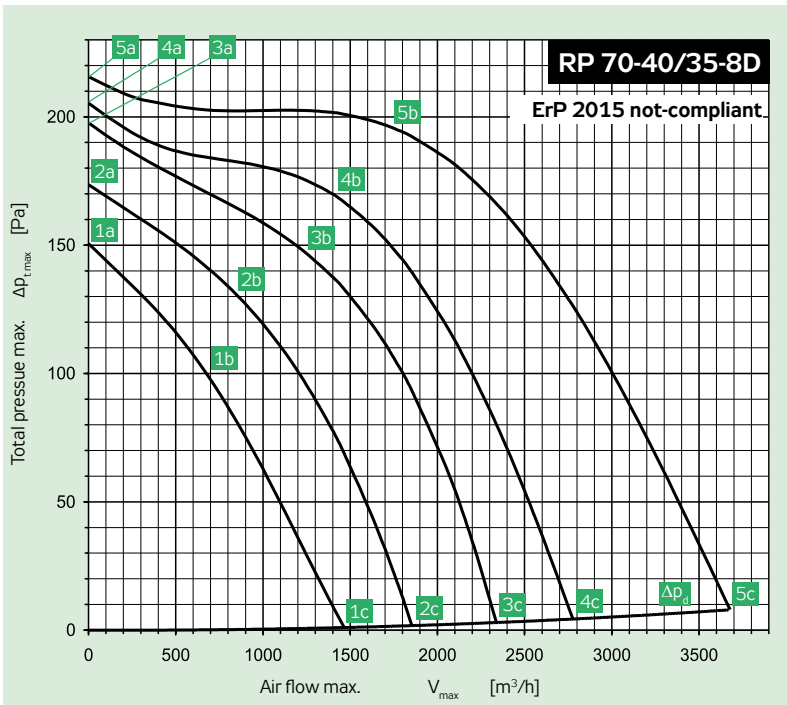

Power supply	Y	3× 400 V	50 Hz
Max. electric input	P_{max}	[W]	642
Max. current (5c)	I_{max}	[A]	1.38
Mean speed	n	[min ⁻¹]	670
Capacitor	C	[F]	-
Max. working temp.	t_{max}	[°C]	55
Air flow max.	V_{max}	[m ³ /h]	3669
Total pressure max.	$\Delta p_{t,max}$	[Pa]	216
Static pressure min. (5c)	$\Delta p_{s,min}$	[Pa]	0
Weight	m	[kg]	44.5
Five-stage controller	type		TRN 2D
Protecting relay	type		STD

	Inlet	Outlet	Surrounding
Point	5b	5b	5b
Total sound power level LWA [dB(A)]			
L_{WA}	68	72	62
Sound power level LWAokt [dB(A)]			
125 Hz	65	64	59
250 Hz	57	63	53
500 Hz	57	66	54
1000 Hz	59	65	53
2000 Hz	59	64	49
4000 Hz	58	63	46
8000 Hz	44	50	40

Parameters in selected working points	5a	5b	5c	4a	4b	4c	3a	3b	3c	2a	2b	2c	1a	1b	1c
Voltage U [V]	400			280			230			180			140		
Current I [A]	0.90	0.97	1.38	0.57	0.71	1.15	0.48	0.64	1.00	0.41	0.53	0.83	0.37	0.49	0.68
Input power P [W]	166	318	642	100	205	390	84	167	277	71	111	179	60	84	113
Speed n [min ⁻¹]	725	673	532	706	631	406	689	592	351	657	573	278	605	495	223
Air flow V [m ³ /h]	0	1815	3669	0	1404	2783	0	1252	2330	0	840	1850	0	697	1468
Static pressure Δp_s [Pa]	216	191	0	205	166	0	198	147	0	174	130	0	151	97	0
Total pressure Δp_t [Pa]	216	193	8	205	167	4	198	148	3	174	130	2	151	97	1

RP
RQ
RO
RE
RF
RPH
EX
TR.
EO..
VO
SUMX
CHV
CHF
HRV
HRZ
PRI

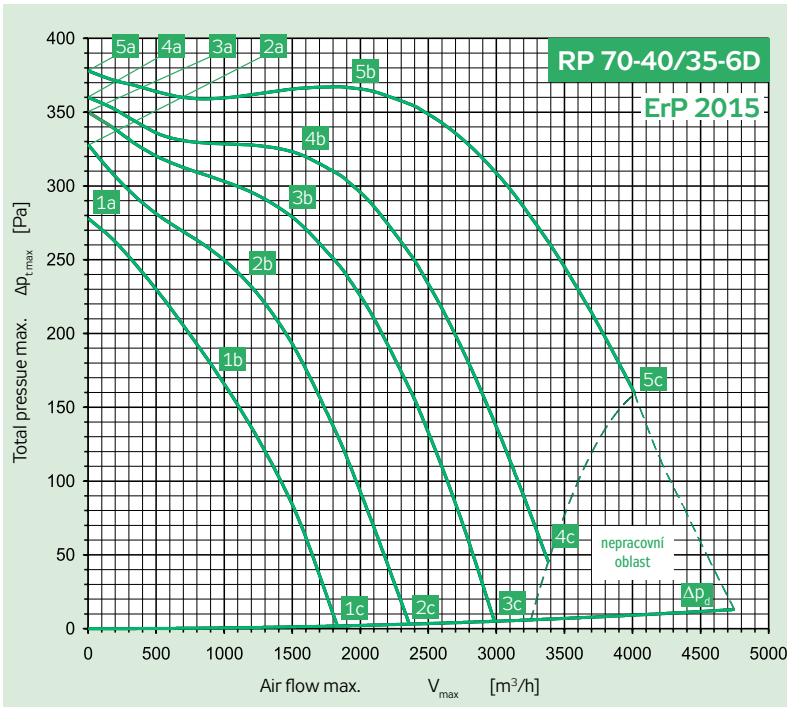

Parameters in selected working points	5a	5b	5c	4a	4b	4c	3a	3b	3c	2a	2b	2c	1a	1b	1c
Voltage U [V]	400			280			230			180			140		
Current I [A]	0.98	1.19	2.00	0.67	0.97	2.00	0.60	0.99	1.92	0.56	0.93	1.60	0.57	0.91	1.29
Input power P [W]	206	500	1096	153	350	784	138	316	600	127	239	392	112	182	243
Speed n [min ⁻¹]	977	922	779	954	872	566	935	813	424	896	756	354	835	644	285
Air flow V [m ³ /h]	0	1992	4032	0	1540	3366	0	1486	2995	0	1167	2384	0	992	1835
Static pressure Δp_s [Pa]	378	367	151	360	319	39	350	279	0	328	234	0	278	167	0
Total pressure Δp_t [Pa]	378	369	160	360	320	45	350	280	5	328	235	3	278	168	2

Power supply	Y	3 × 400 V	50 Hz
Max. electric input	P_{max}	[W]	1096
Max. current (5c)	I_{max}	[A]	2.00
Mean speed	n	[min ⁻¹]	920
Capacitor	C	[F]	-
Max. working temp.	t_{max}	[°C]	40
Air flow max.	V_{max}	[m ³ /h]	4032
Total pressure max.	$\Delta p_{t,max}$	[Pa]	378
Static pressure min. (5c)	$\Delta p_{s,min}$	[Pa]	151
Weight	m	[kg]	43.5
Five-stage controller	type		TRN 4D
Protecting relay	type		STD

	Inlet	Outlet	Surrounding
Point	5b	5b	5b
Total sound power level LWA [dB(A)]			
L_{WA}	74	79	69
Sound power level LWAokt [dB(A)]			
125 Hz	68	70	60
250 Hz	64	69	58
500 Hz	63	73	61
1000 Hz	66	73	62
2000 Hz	64	71	60
4000 Hz	63	69	57
8000 Hz	52	58	49

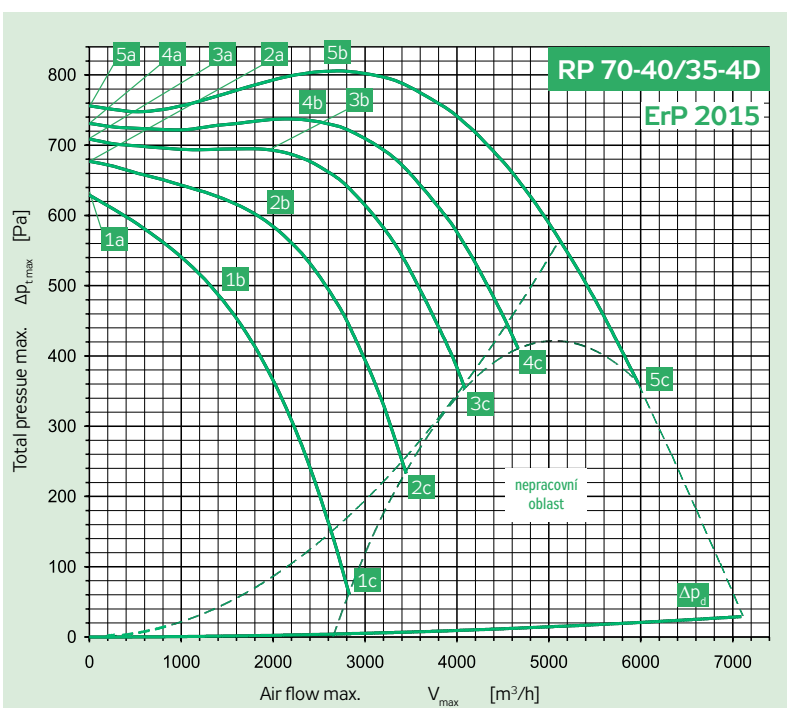

Parameters in selected working points	5a	5b	5c	4a	4b	4c	3a	3b	3c	2a	2b	2c	1a	1b	1c
Voltage U [V]	400			280			230			180			140		
Current I [A]	1.98	2.67	6.00	1.54	2.61	6.00	1.41	2.68	6.00	1.84	3.34	6.00	1.98	3.27	5.73
Input power P [W]	442	1231	3527	483	1065	2522	410	931	2028	503	924	1520	437	697	1055
Speed n [min ⁻¹]	1478	1442	1312	1457	1397	1189	1441	1355	1083	1387	1244	891	1327	1157	598
Air flow V [m ³ /h]	0	2577	5981	0	2148	4675	0	1979	4136	0	1977	3435	0	1410	2817
Static pressure Δp_s [Pa]	756	804	340	731	741	399	709	688	332	677	588	226	629	485	56
Total pressure Δp_t [Pa]	756	806	361	731	744	411	709	690	342	677	590	233	629	486	60

Power supply	Y	3 × 400 V	50 Hz
Max. electric input	P_{max}	[W]	3527
Max. current (5c)	I_{max}	[A]	6.00
Mean speed	n	[min ⁻¹]	1440
Capacitor	C	[F]	-
Max. working temp.	t_{max}	[°C]	40
Air flow max.	V_{max}	[m ³ /h]	5981
Total pressure max.	$\Delta p_{t,max}$	[Pa]	806
Static pressure min. (5c)	$\Delta p_{s,min}$	[Pa]	340
Weight	m	[kg]	62
Five-stage controller	type		TRN 7D
Protecting relay	type		STD

	Inlet	Outlet	Surrounding
Point	5b	5b	5b
Total sound power level LWA [dB(A)]			
L_{WA}	84	90	77
Sound power level LWAokt [dB(A)]			
125 Hz	77	79	70
250 Hz	75	78	68
500 Hz	74	83	71
1000 Hz	78	85	72
2000 Hz	78	83	67
4000 Hz	74	81	64
8000 Hz	64	70	54

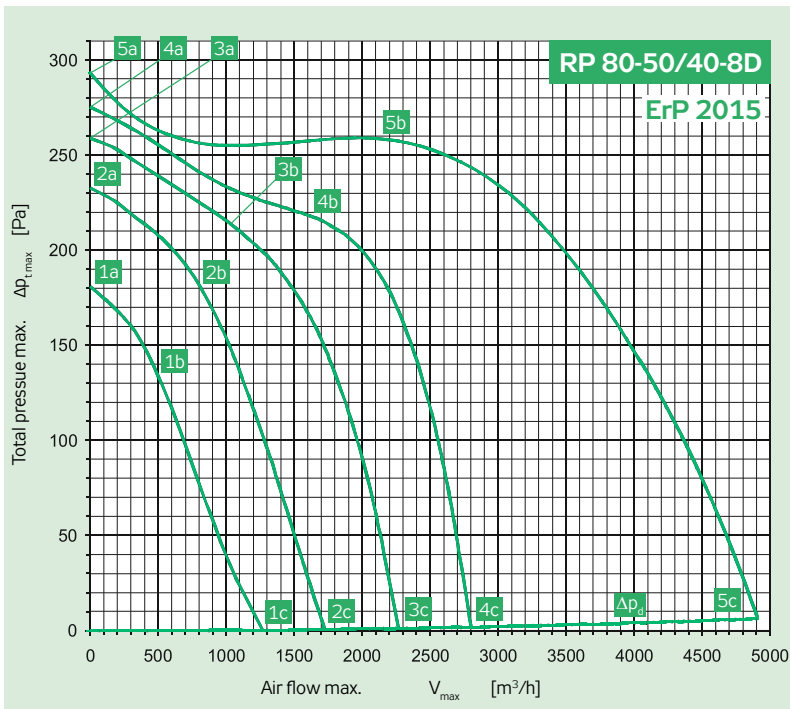

Power supply	Y	3× 400 V	50 Hz
Max. electric input	P_{max}	[W]	1230
Max. current (5c)	I_{max}	[A]	2.29
Mean speed	n	[min ⁻¹]	700
Capacitor	C	[F]	-
Max. working temp.	t_{max}	[°C]	55
Air flow max.	V_{max}	[m ³ /h]	4720
Total pressure max.	$\Delta p_{t,max}$	[Pa]	298
Static pressure min. (5c)	$\Delta p_{s,min}$	[Pa]	0
Weight	m	[kg]	57.1
Five-stage controller	type		TRN 4D
Protecting relay	type		STD

	Inlet	Outlet	Surrounding
Point	5b	5b	5b
Total sound power level LWA [dB(A)]			
L_{WA}	69	74	63
Sound power level LWAokt [dB(A)]			
125 Hz	62	61	58
250 Hz	60	63	56
500 Hz	59	68	56
1000 Hz	62	68	56
2000 Hz	62	68	52
4000 Hz	60	65	47
8000 Hz	48	52	41

Parameters in selected working points	5a	5b	5c	4a	4b	4c	3a	3b	3c	2a	2b	2c	1a	1b	1c
Voltage U [V]		400			280			230			180			140	
Current I [A]	0.88	1.05	2.29	0.56	0.85	1.80	0.53	0.72	1.52	0.54	0.70	1.24	0.62	0.72	1.00
Input power P [W]	239	476	1230	159	321	646	147	226	438	136	180	271	115	132	158
Speed n [min ⁻¹]	736	698	478	713	646	291	696	646	234	658	604	183	578	510	147
Air flow V [m ³ /h]	0	2145	4720	0	1652	2800	0	1083	2259	0	802	1737	0	558	1343
Static pressure Δp_s [Pa]	298	256	0	275	216	0	259	208	0	233	180	0	181	129	0
Total pressure Δp_t [Pa]	298	257	6	275	217	2	259	208	1	233	180	1	181	129	0

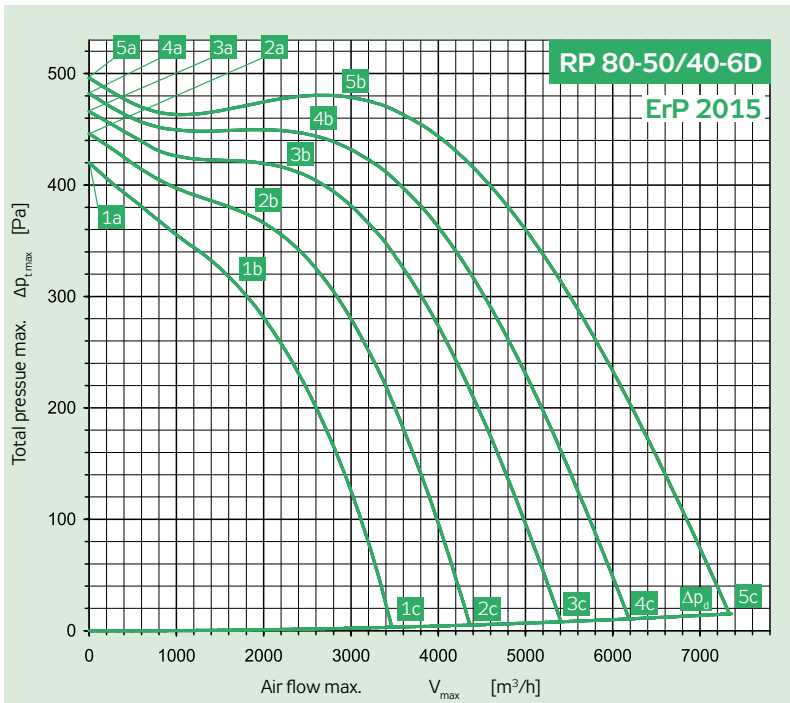

Power supply	Y	3× 400 V	50 Hz
Max. electric input	P_{max}	[W]	2824
Max. current (5c)	I_{max}	[A]	5.11
Mean speed	n	[min ⁻¹]	960
Capacitor	C	[F]	-
Max. working temp.	t_{max}	[°C]	50
Air flow max.	V_{max}	[m ³ /h]	7357
Total pressure max.	$\Delta p_{t,max}$	[Pa]	496
Static pressure min. (5c)	$\Delta p_{s,min}$	[Pa]	0
Weight	m	[kg]	71
Five-stage controller	type		TRN 7D
Protecting relay	type		STD

	Inlet	Outlet	Surrounding
Point	5b	5b	5b
Total sound power level LWA [dB(A)]			
L_{WA}	77	81	68
Sound power level LWAokt [dB(A)]			
125 Hz	70	68	62
250 Hz	66	68	58
500 Hz	69	75	58
1000 Hz	71	75	60
2000 Hz	70	74	63
4000 Hz	67	72	53
8000 Hz	58	61	47

Parameters in selected working points	5a	5b	5c	4a	4b	4c	3a	3b	3c	2a	2b	2c	1a	1b	1c
Voltage U [V]		230			180			160			130			105	
Current I [A]	2.17	2.58	5.11	1.43	2.08	4.99	1.22	2.03	4.90	1.11	2.00	4.40	1.08	2.10	3.80
Input power P [W]	441	1013	2824	276	724	1957	264	633	1556	229	512	1044	201	421	678
Speed n [min ⁻¹]	992	960	835	980	928	710	967	899	621	948	853	507	917	774	409
Air flow V [m ³ /h]	0	2918	7357	0	2518	6207	0	2255	5393	0	1943	4364	0	1767	3462
Static pressure Δp_s [Pa]	496	479	0	482	447	0	466	415	0	446	368	0	420	304	0
Total pressure Δp_t [Pa]	496	481	15	482	449	11	466	416	8	446	369	5	420	305	3

RP
RQ
RO
RE
RF
RPH
EX
TR.
EO..
VO
SUMX
CHV
CHF
HRV
HRZ
PRI

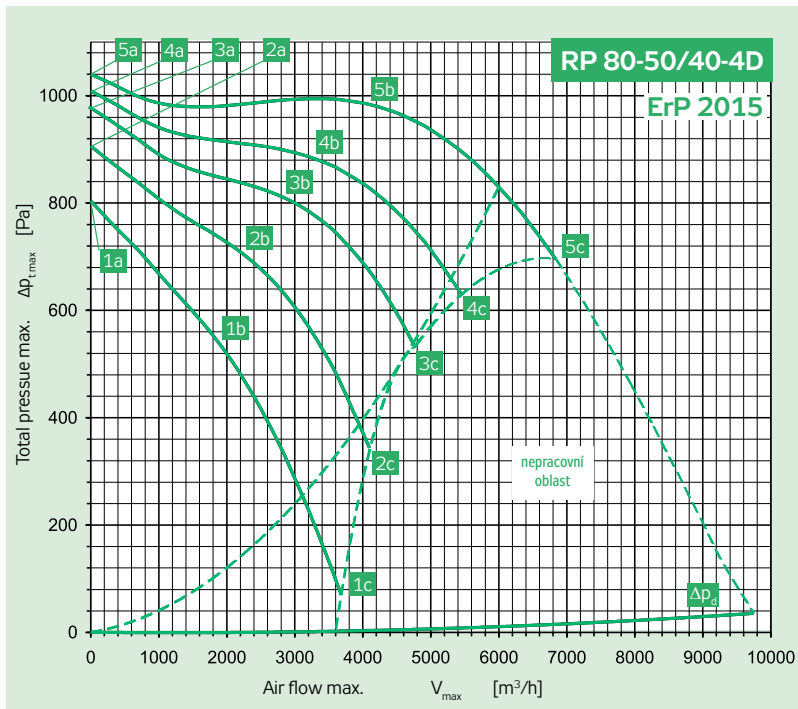

Power supply	Y	3 × 400 V	50 Hz
Max. electric input	P _{max}	[W]	4919
Max. current (5c)	I _{max}	[A]	8.10
Mean speed	n	[min ⁻¹]	1410
Capacitor	C	[F]	-
Max. working temp.	t _{max}	[°C]	40
Air flow max.	V _{max}	[m³/h]	6831
Total pressure max.	Δ p _{t,max}	[Pa]	1040
Static pressure min. (5c)	Δ p _{s,min}	[Pa]	683
Weight	m	[kg]	78
Five-stage controller	type		TRN 9D
Protecting relay	type		STD

	Inlet	Outlet	Surrounding
Point	5b	5b	5b
Total sound power level LWA [dB(A)]			
L _{WA}	88	92	77
Sound power level LWAokt [dB(A)]			
125 Hz	81	76	71
250 Hz	74	78	67
500 Hz	74	83	68
1000 Hz	83	88	72
2000 Hz	82	86	69
4000 Hz	78	84	64
8000 Hz	70	73	65

Parameters in selected working points	5a	5b	5c	4a	4b	4c	3a	3b	3c	2a	2b	2c	1a	1b	1c
Voltage U [V]	400			280			230			180			140		
Current I [A]	3.00	5.01	8.10	2.38	4.91	8.10	2.33	4.93	8.10	2.54	4.88	8.10	2.96	5.21	8.10
Input power P [W]	1217	2915	4919	903	2143	3498	782	1770	2800	721	1379	2117	671	1110	1516
Speed n [min ⁻¹]	1480	1414	1322	1452	1348	1195	1427	1293	1088	1380	1214	890	1298	1055	548
Air flow V [m³/h]	0	4135	6831	0	3307	5456	0	2894	4763	0	2306	4109	0	1957	3673
Static pressure Δp _s [Pa]	1040	982	683	1009	885	621	977	808	525	906	692	339	804	520	67
Total pressure Δp _t [Pa]	1040	987	696	1009	888	630	977	810	532	906	693	344	804	521	70

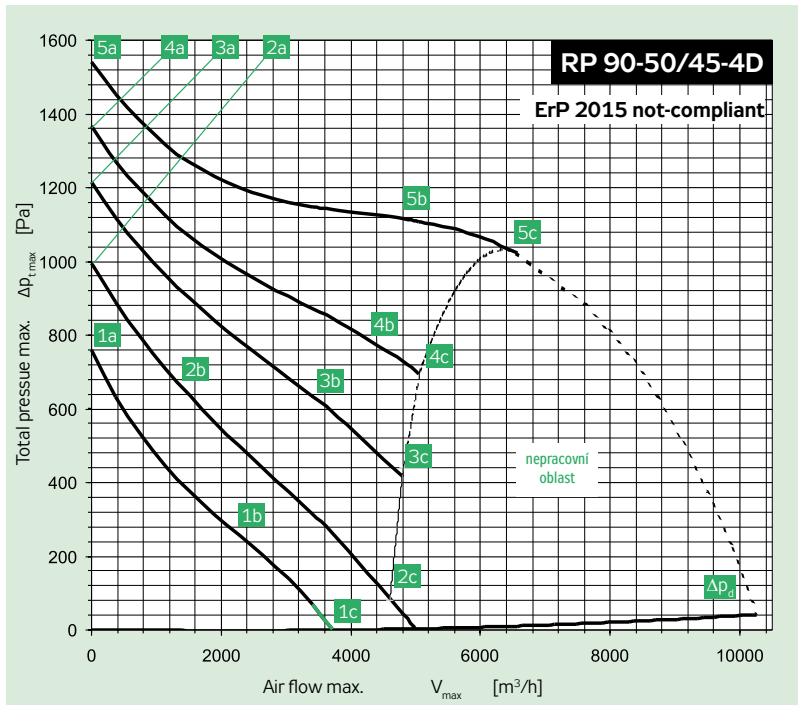

Power supply	D	3 × 400 V	50 Hz
Max. electric input	P _{max}	[W]	4919
Max. current (5c)	I _{max}	[A]	8.30
Mean speed	n	[min ⁻¹]	1260
Capacitor	C	[F]	-
Max. working temp.	t _{max}	[°C]	55
Air flow max.	V _{max}	[m³/h]	6558
Total pressure max.	Δ p _{t,max}	[Pa]	1541
Static pressure min. (5c)	Δ p _{s,min}	[Pa]	1014
Weight	m	[kg]	96
Five-stage controller	type		TRN 9D
Protecting relay	type		STD

	Inlet	Outlet	Surrounding
Point	5b	5b	5b
Total sound power level LWA [dB(A)]			
L _{WA}	88	95	79
Sound power level LWAokt [dB(A)]			
125 Hz	74	75	72
250 Hz	73	80	69
500 Hz	78	88	72
1000 Hz	83	91	74
2000 Hz	83	90	71
4000 Hz	79	85	66
8000 Hz	71	76	55

Parameters in selected working points	5a	5b	5c	4a	4b	4c	3a	3b	3c	2a	2b	2c	1a	1b	1c
Voltage U [V]	400			280			230			180			140		
Current I [A]	3.74	7.20	8.30	3.44	7.41	8.30	3.65	6.97	8.30	4.07	5.07	8.17	4.11	5.50	6.32
Input power P [W]	1993	4269	4919	1402	3055	3367	1259	2318	2718	1073	1330	1927	829	1041	1119
Speed n [min ⁻¹]	1396	1259	1211	1343	1069	997	1280	957	800	1137	1009	376	978	623	285
Air flow V [m³/h]	0	5512	6558	0	4398	5055	0	3583	4805	0	1543	4986	0	2286	3707
Static pressure Δp _s [Pa]	1541	1111	1014	1367	777	693	1216	617	435	994	652	0	758	267	0
Total pressure Δp _t [Pa]	1541	1118	1023	1367	781	699	1216	619	440	994	652	5	758	268	3

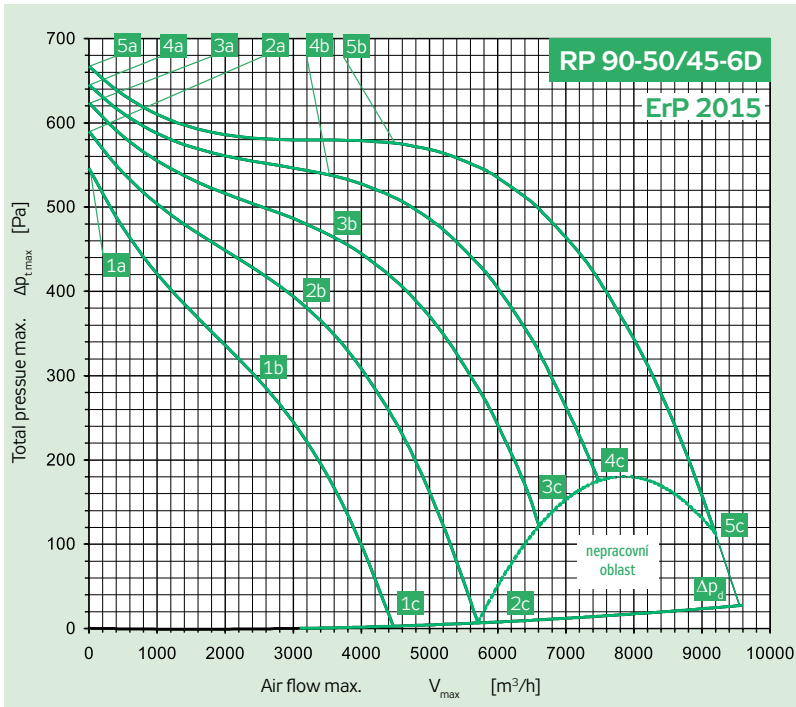

Power supply	Y	3 × 400 V	50 Hz
Max. electric input	P_{max}	[W]	3780
Max. current (5c)	I_{max}	[A]	6.80
Mean speed	n	[min ⁻¹]	930
Capacitor	C	[F]	-
Max. working temp.	t_{max}	[°C]	55
Air flow max.	V_{max}	[m ³ /h]	9200
Total pressure max.	$\Delta p_{t,max}$	[Pa]	667
Static pressure min. (5c)	$\Delta p_{s,min}$	[Pa]	90
Weight	m	[kg]	96
Five-stage controller	type		TRN 7D
Protecting relay	type		STD

	Inlet	Outlet	Surrounding
Point	5b	5b	5b
Total sound power level LWA [dB(A)]			
L_{WA}	81	88	68
Sound power level LWAokt [dB(A)]			
125 Hz	65	66	61
250 Hz	65	72	60
500 Hz	74	83	62
1000 Hz	75	82	62
2000 Hz	76	82	59
4000 Hz	72	78	54
8000 Hz	64	68	42

Parameters in selected working points	5a	5b	5c	4a	4b	4c	3a	3b	3c	2a	2b	2c	1a	1b	1c
Voltage U [V]	400			280			230			180			140		
Current I [A]	2.96	3.87	6.80	2.15	3.45	6.80	1.99	3.75	6.80	1.98	3.86	6.66	2.03	3.74	5.59
Input power P [W]	665	1757	3780	564	1315	2785	518	1242	2271	476	1025	1640	415	760	1040
Speed n [min ⁻¹]	968	926	832	948	879	713	931	825	621	899	749	443	846	659	351
Air flow V [m ³ /h]	0	4463	9200	0	3575	7483	0	3503	6609	0	3154	5712	0	2550	4462
Static pressure Δp_s [Pa]	667	574	90	645	541	163	624	467	111	590	381	0	546	295	0
Total pressure Δp_t [Pa]	667	578	112	645	544	175	624	470	121	590	383	7	546	296	4

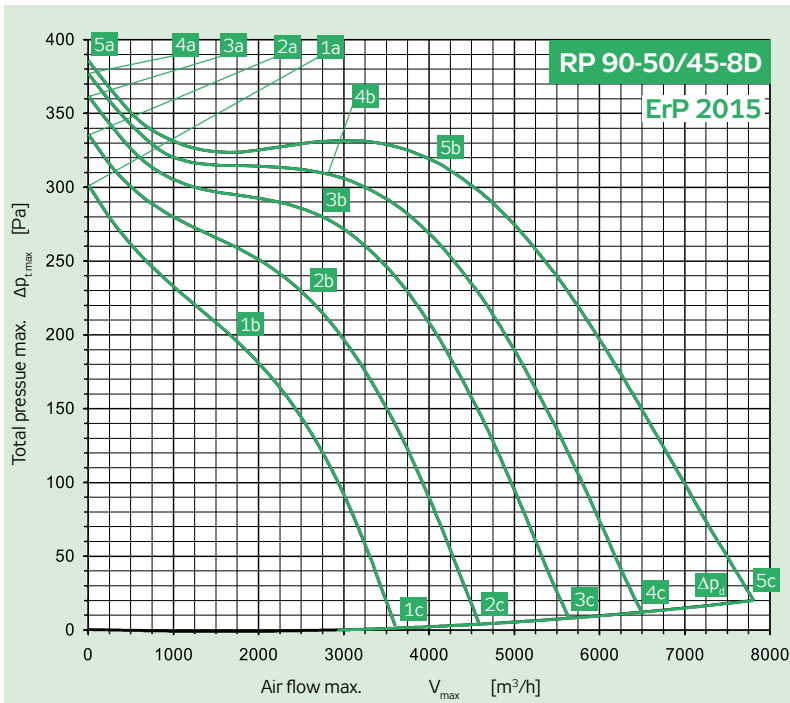

Power supply	Y	3 × 400 V	50 Hz
Max. electric input	P_{max}	[W]	1892
Max. current (5c)	I_{max}	[A]	3.88
Mean speed	n	[min ⁻¹]	690
Capacitor	C	[F]	-
Max. working temp.	t_{max}	[°C]	55
Air flow max.	V_{max}	[m ³ /h]	7810
Total pressure max.	$\Delta p_{t,max}$	[Pa]	386
Static pressure min. (5c)	$\Delta p_{s,min}$	[Pa]	0
Weight	m	[kg]	93
Five-stage controller	type		TRN 4D
Protecting relay	type		STD

	Inlet	Outlet	Surrounding
Point	5b	5b	5b
Total sound power level LWA [dB(A)]			
L_{WA}	74	81	62
Sound power level LWAokt [dB(A)]			
125 Hz	59	58	54
250 Hz	61	69	55
500 Hz	68	77	57
1000 Hz	64	74	55
2000 Hz	69	75	52
4000 Hz	65	71	45
8000 Hz	55	61	39

Parameters in selected working points	5a	5b	5c	4a	4b	4c	3a	3b	3c	2a	2b	2c	1a	1b	1c
Voltage U [V]	400			280			230			180			140		
Current I [A]	2.20	2.49	3.88	1.54	2.03	3.78	1.32	1.87	3.61	1.14	1.92	3.20	1.08	1.67	2.73
Input power P [W]	350	813	1892	264	624	1398	222	518	1081	196	455	733	178	311	477
Speed n [min ⁻¹]	725	694	610	715	661	505	704	641	434	683	577	349	646	543	277
Air flow V [m ³ /h]	0	3522	7810	0	2951	6493	0	2529	5632	0	2474	4581	0	1675	3603
Static pressure Δp_s [Pa]	386	328	0	377	307	0	362	284	0	336	230	0	302	195	0
Total pressure Δp_t [Pa]	386	329	20	377	309	12	362	286	9	336	232	5	302	195	3

RP
RQ
RO
RE
RF
RPH
EX
TR.
EO..
VO
SUMX
CHV
CHF
HRV
HRZ
PRI

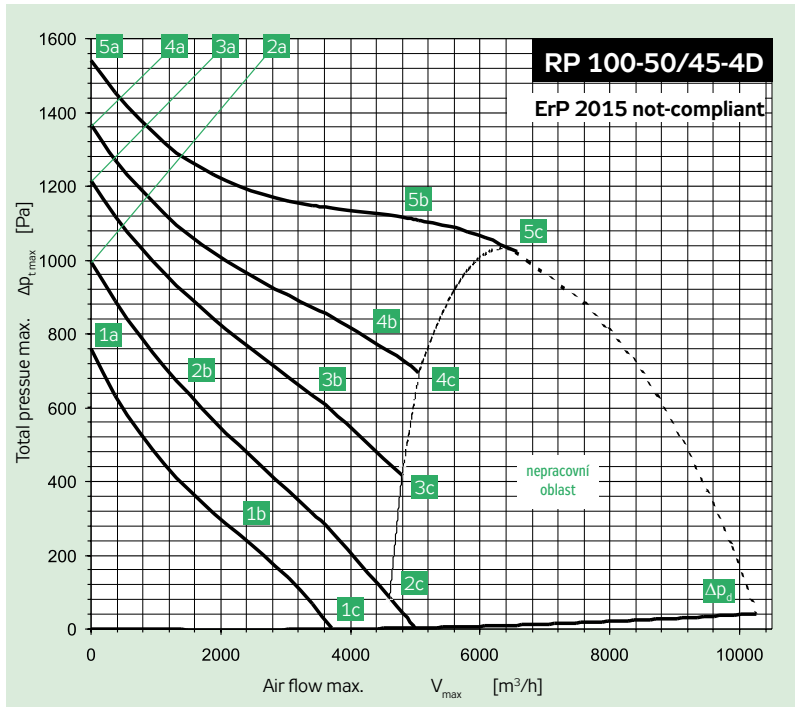

Power supply	D	3 × 400 V	50 Hz
Max. electric input	P _{max}	[W]	4919
Max. current (5c)	I _{max}	[A]	8.30
Mean speed	n	[min ⁻¹]	1260
Capacitor	C	[F]	-
Max. working temp.	t _{max}	[°C]	55
Air flow max.	V _{max}	[m ³ /h]	6558
Total pressure max.	Δ p _{t max}	[Pa]	1541
Static pressure min. (5c)	Δ p _{s min}	[Pa]	1014
Weight	m	[kg]	96
Five-stage controller	type		TRN 9D
Protecting relay	type		STD

	Inlet	Outlet	Surrounding
Point	5b	5b	5b
Total sound power level LWA [dB(A)]			
L _{WA}	88	95	79
Sound power level LWAokt [dB(A)]			
125 Hz	74	75	72
250 Hz	73	80	69
500 Hz	78	88	72
1000 Hz	83	91	74
2000 Hz	83	90	71
4000 Hz	79	85	66
8000 Hz	71	76	55

Parameters in selected working points	5a	5b	5c	4a	4b	4c	3a	3b	3c	2a	2b	2c	1a	1b	1c
Voltage U [V]		400			280			230			180			140	
Current I [A]	3.74	7.20	8.30	3.44	7.41	8.30	3.65	6.97	8.30	4.07	5.07	8.17	4.11	5.50	6.32
Input power P [W]	1993	4269	4919	1402	3055	3367	1259	2318	2718	1073	1330	1927	829	1041	1119
Speed n [min ⁻¹]	1396	1259	1211	1343	1069	997	1280	957	800	1137	1009	376	978	623	285
Air flow V [m ³ /h]	0	5512	6558	0	4398	5055	0	3583	4805	0	1543	4986	0	2286	3707
Static pressure Δ p _s [Pa]	1541	1089	1014	1367	787	693	1216	617	435	994	652	0	758	257	0
Total pressure Δ p _t [Pa]	1541	1096	1023	1367	791	699	1216	619	440	994	652	5	758	258	3

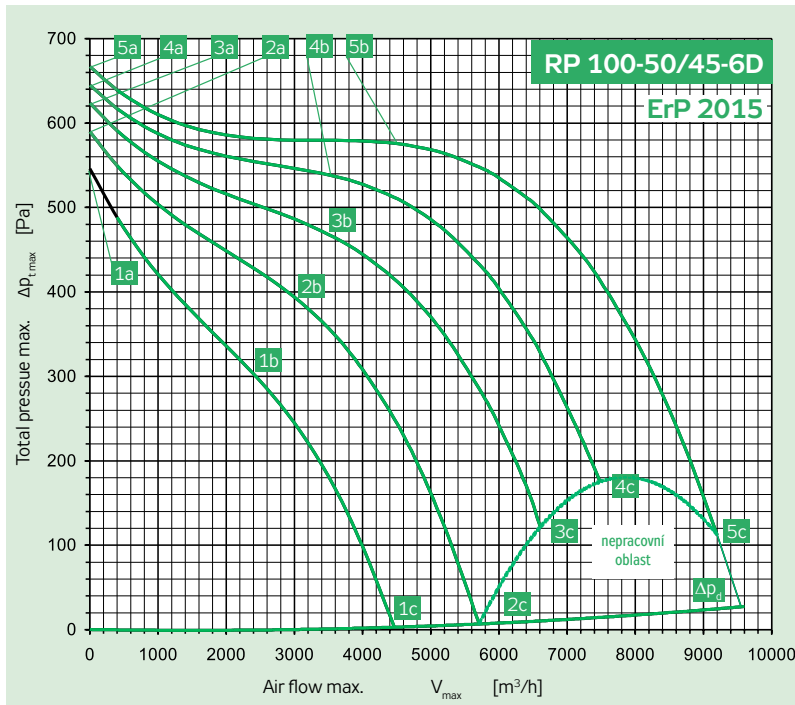

Power supply	Y	3 × 400 V	50 Hz
Max. electric input	P _{max}	[W]	3780
Max. current (5c)	I _{max}	[A]	6.80
Mean speed	n	[min ⁻¹]	930
Capacitor	C	[F]	-
Max. working temp.	t _{max}	[°C]	55
Air flow max.	V _{max}	[m ³ /h]	9200
Total pressure max.	Δ p _{t max}	[Pa]	667
Static pressure min. (5c)	Δ p _{s min}	[Pa]	90
Weight	m	[kg]	96
Five-stage controller	type		TRN 7D
Protecting relay	type		STD

	Inlet	Outlet	Surrounding
Point	5b	5b	5b
Total sound power level LWA [dB(A)]			
L _{WA}	81	88	68
Sound power level LWAokt [dB(A)]			
125 Hz	65	66	61
250 Hz	65	72	60
500 Hz	74	83	62
1000 Hz	75	82	62
2000 Hz	76	82	59
4000 Hz	72	78	54
8000 Hz	64	68	42

Parameters in selected working points	5a	5b	5c	4a	4b	4c	3a	3b	3c	2a	2b	2c	1a	1b	1c
Voltage U [V]		400			280			230			180			140	
Current I [A]	2.96	3.87	6.80	2.15	3.45	6.80	1.99	3.75	6.80	1.98	3.86	6.66	2.03	3.74	5.59
Input power P [W]	665	1757	3780	564	1315	2785	518	1242	2271	476	1025	1640	415	760	1040
Speed n [min ⁻¹]	968	926	832	948	879	713	931	825	621	899	749	443	846	659	351
Air flow V [m ³ /h]	0	4463	9200	0	3575	7483	0	3503	6609	0	3154	5712	0	2550	4462
Static pressure Δ p _s [Pa]	667	574	90	645	541	163	624	467	111	590	381	0	546	295	0
Total pressure Δ p _t [Pa]	667	578	112	645	544	175	624	470	121	590	383	7	546	296	4

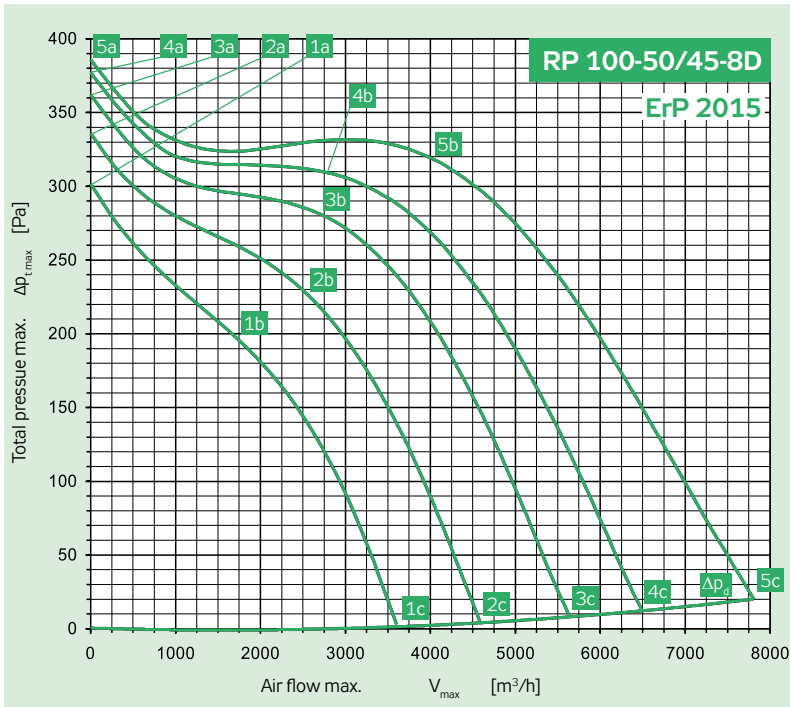

Power supply	Y	3 × 400 V	50 Hz
Max. electric input	P _{max}	[W]	1892
Max. current (5c)	I _{max}	[A]	3.88
Mean speed	n	[min ⁻¹]	690
Capacitor	C	[F]	-
Max. working temp.	t _{max}	[°C]	55
Air flow max.	V _{max}	[m ³ /h]	7810
Total pressure max.	Δ p _{t,max}	[Pa]	386
Static pressure min. (5c)	Δ p _{s,min}	[Pa]	0
Weight	m	[kg]	93
Five-stage controller	type		TRN 4D
Protecting relay	type		STD

	Inlet	Outlet	Surrounding
Point	5b	5b	5b
Total sound power level LWA [dB(A)]			
L _{WA}	74	81	62
Sound power level LWA _{okt} [dB(A)]			
125 Hz	59	58	54
250 Hz	61	69	55
500 Hz	68	77	57
1000 Hz	64	74	55
2000 Hz	69	75	52
4000 Hz	65	71	45
8000 Hz	55	61	39

Parameters in selected working points	5a	5b	5c	4a	4b	4c	3a	3b	3c	2a	2b	2c	1a	1b	1c
Voltage U [V]	400			280			230			180			140		
Current I [A]	2.20	2.49	3.88	1.54	2.03	3.78	1.32	1.87	3.61	1.14	1.92	3.20	1.08	1.67	2.73
Input power P [W]	350	813	1892	264	624	1398	222	518	1081	196	455	733	178	311	477
Speed n [min ⁻¹]	725	694	610	715	661	505	704	641	434	683	577	349	646	543	277
Air flow V [m ³ /h]	0	3522	7810	0	2951	6493	0	2529	5632	0	2474	4581	0	1675	3603
Static pressure Δp _s [Pa]	386	328	0	377	307	0	362	284	0	336	230	0	302	195	0
Total pressure Δp _t [Pa]	386	329	20	377	309	12	362	286	9	336	232	5	302	195	3

- RP
- RQ
- RO
- RE
- RF
- RPH
- EX
- TR..
- EO..
- VO
- SUMX
- CHV
- CHF
- HRV
- HRZ
- PRI

INSTALLATION

- RP fans (including other Vento elements and equipment) are not intended, due to their concept, for direct sale to end customers. Each installation must be performed in accordance with a professional project created by a qualified air-handling designer who is responsible for the proper selection of fan. The installation and commissioning may be performed only by an authorized company licensed in accordance with generally valid regulations.
 - It is recommended to insert the DV elastic connections in front of and behind the fan.
 - It is advisable to always place the KFD or VFK air filters, respectively VFT metal grease filter in front of the fan to protect the fan and duct against dirtying and dust fouling,
 - In cramped areas, it is advisable to consider the necessity to situate directly behind the fan's outlet the duct adapting piece, attenuator, heat exchanger, heater, etc. Figure # 3 shows the fan's outlet design and arrangement. It is obvious that from the entire cross-section (e.g. 500 x 250) only 1/4 of the outlet cross-section is free. This means that the airflow velocities close behind the fan can be as much as four times higher than, for example, in the inlet. Therefore, the greater the distance of attenuators (or other resistant elements) from the outlet, the better ¹⁾.
- On the inlet side, the DV elastic connection will be sufficient as a distance piece in most cases.

¹⁾ That recommendation applies to all duct fans.

WIRING

- The wiring can be performed only by a qualified worker licensed in accordance with national regulations.
- An all-plastic terminal box fixed with screws to the fan casing is equipped with WAGO terminals; max. cross-section of connecting conductors 1.5 mm²
- The fans are equipped with thermo-contacts situated in the motor winding; they are connected to the TK terminals. If the motor is overloaded, the thermo-contact will open. To evaluate the failure, the thermo-contact must be connected to the control or regulating system (e.g. control unit, TRN controller or STE(D) relay) which is able to evaluate the failure, and protect the motor against unwanted thermal effects.

FIGURE 6 – WIRING DIAGRAM

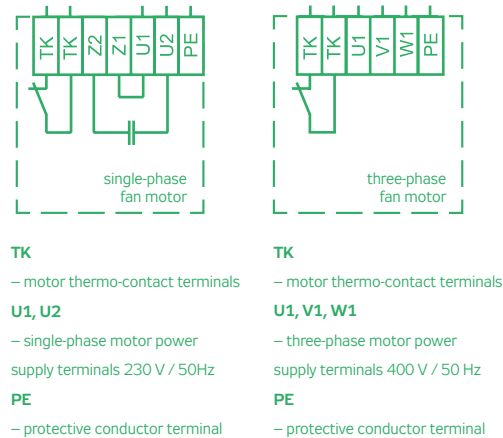

The wiring diagrams with front-end elements (protective relays, controllers, control units) are included in the installation manual, respectively in the AeroCAD project.

On the following pages you will find some basic examples of the fan connection to output controllers and control units. AeroCAD software is available for precise design of the wiring.

EXAMPLE A
RP FANS WITHOUT OUTPUT CONTROL
AND WITH STE(D) PROTECTING RELAY

The RP fan connection in a simple venting system without output control is shown in figure # 7.

This connection ensures:

- Full thermal protection of the fan using thermo-contacts and protecting relay, STE (single-phase) or STD (three-phase).
- Manual switching of the fan on/off using buttons on the STE(D) protecting relay.

After pressing the button marked "I" on the STE(D) protecting relay, the fan starts and the button will stay in the depressed position, signalling the fan's operation. The fan can be stopped by pressing the button marked "O".
 If the motor winding is overheated above 130 °C due to overloading, the thermo-contacts in the motor winding will open. Upon the thermo-contacts opening, which are interconnected with the fan terminal box, the STE(D) protecting relay circuit TK, TK will be disconnected. As a reaction to this state, the STE(D) protecting relay will disconnect the power supply to the overheated motor. After cooling down, the motor is not automatically restarted. The failure must be confirmed (unblocked) by the operator by pressing the red "I" button.

FIGURE 7 – FAN CONNECTION

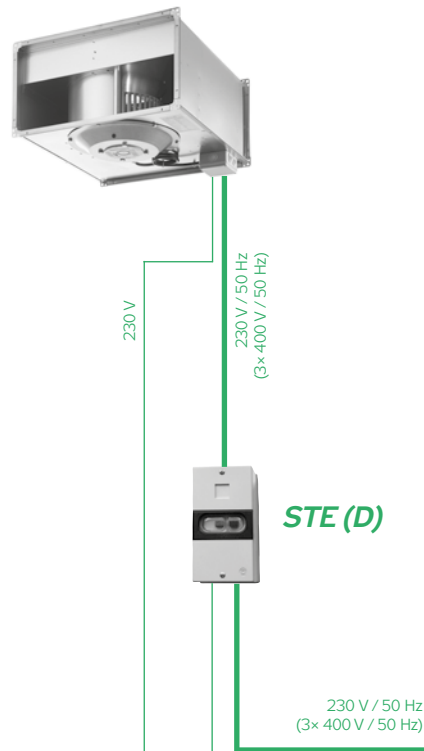

EXAMPLE B
RP FANS WITH OUTPUT CONTROL
AND TRN CONTROLLER

The RP fan connection in a venting system with output control using TRN controller with ORe5 controller is shown in figure # 8.

This connection ensures:

- The possibility of fan output selection within the stage range 1-5 as well as full protection via thermo-contacts.
- Fan switching on/off manually, by the ORe5 remote controller or any other switch (like room thermostat, gas detector, pressostat, hygostat, etc).

Upon selecting the required output stage using a selector on the ORe5 controller the fan will start at corresponding speed. The closed switch connected to PT1, PT2 terminals and the thermo-contact circuit connected to TK,TK terminals are essential for the fan operation. The switch connected to PT1, PT2 terminals can externally stop the fan. If this option is not used, it will be necessary to interconnect terminals PT1 and PT2.
 If the fan is overloaded, the thermo-contact circuit will be disconnected due to overheating of the motor winding. As a reaction to this state, the controller will disconnect the fan power supply, and the red control light on the ORe controller will signal the failure. After cooling down, the motor is not automatically restarted. To restart the fan, it is necessary first to set the selector to the "STOP" position, and thus confirm failure removal, and then to set the required fan output. In this arrangement, the option "STOP" on ORe5 must not be blocked.

FIGURE 8 – FAN CONNECTION

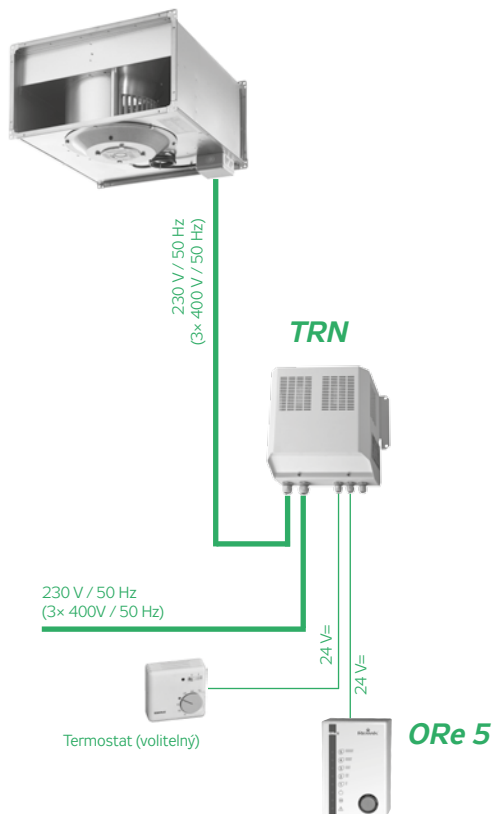

RP
 RQ
 RO
 RE
 RF
 RPH
 EX
 TR..
 EO..
 VO
 SUMX
 CHV
 CHF
 HRV
 HRZ
 PRI

**EXAMPLE C
RP FANS WITHOUT OUTPUT CONTROL
AND WITH CONTROL UNIT**

The RP fan without output control connection in more sophisticated venting systems using the control unit is shown in figure # 9. This connection ensures:

- Full thermal protection of the fan via thermo-contacts and control unit.
- Fan switching on/off by the control unit. The motor protection must always be ensured by the control unit while TK,TK thermo-contact terminals are connected to 5a, 5a, 5b, 5b terminals in the control unit.

The air-handling system is started by the control unit. All protecting and safety functions of the fan as well as the entire system are ensured by the control unit.

FIGURE 9 – FAN CONNECTION

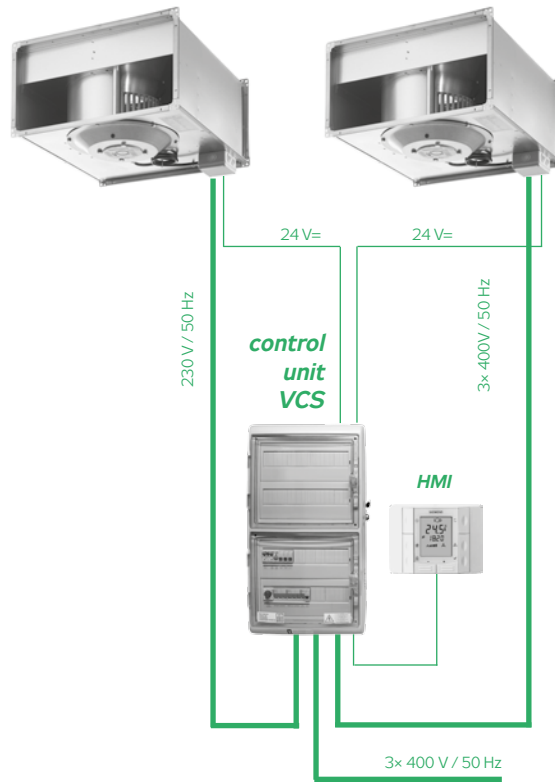

**EXAMPLE D
RP FANS WITH TRN CONTROLLERS
AND CONTROL UNIT**

The RP fan with TRN output controllers and a common internal controller in more sophisticated venting systems using the control unit is shown in figure # 10. The internal control is installed in the control unit during production.

This connection ensures:

- Fan switching on/off by the control unit. The motor protection must always be ensured by the control unit while TK,TK thermo-contact terminals are connected to 5a, 5a, 5b, 5b terminals in the control unit.
- Fan output control within the stage range 1-5 manually via HMI controller or using time schedule function of the control unit.

In the connection with control unit, all additional functions of the controller must always be blocked by interconnecting the PT2 and E48 terminals in the TRN-D controller..

The air-handling system is started by the control unit. All protecting and safety functions of fans as well as the entire system are ensured by the control unit.

FIGURE 10 – FAN CONNECTION

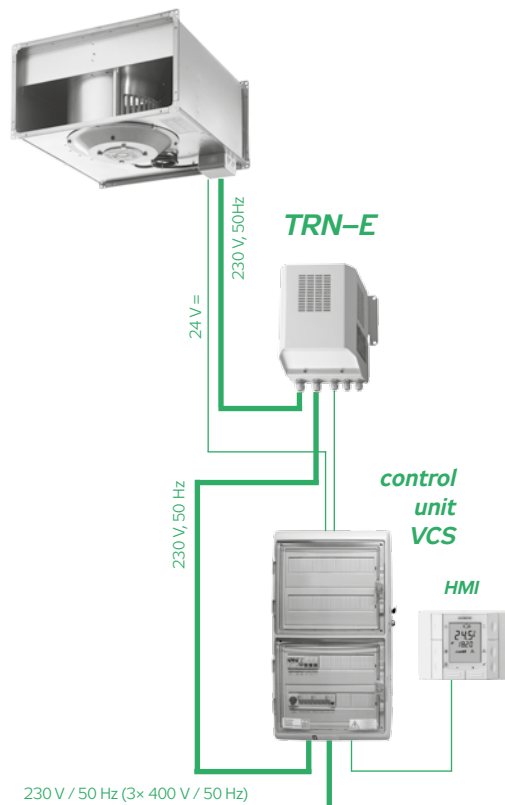

EXAMPLE E
RP FANS WITH AUTOMATIC OUTPUT CONTROL,
TRN CONTROLLER AND OSX CONTROL UNIT

The RP fan connection in a special venting system with automatic output control using TRN controller and OSX control unit is shown in figure # 18. Two TRN controllers can be controlled by the OSX control unit. The fans are controlled together to the same output. Tento způsob zapojení zabezpečuje:

- Automatic selection of the fan output within the stage range 0 - 5 as well as its protection via thermo-contacts and the protection integrated into the TRN controller. Automatic selection of the controller output stage is ensured by the OX controller integrated into the OSX control unit in relation to any physical quantity which is read by the active sensor equipped with an analogue output (signal source 0- -10V). The OSX control unit has several additional functions. One of them is the possibility to stop fan operation using the "STOP" button regardless of the value of the input voltage.
- Manual start of the system at the output stage corresponding to the selected voltage. Regardless of the actual value of the control voltage, it is possible, using the "MANUAL" button, to connect the input of the OX controller for the voltage selected by the TEST trimmer OX controller. The OX controller factory default setting of this button feature is to the full output.

The fans in the picture are started, controlled and protected by TRN controller. Automatic OX controller evaluates the continuous signal of 0-10V coming from the converter (source of the signal) and in six adjustable levels switches stages 0-5. Thermal or pressure converter, converters for measurement of relative or absolute humidity, concentration of gas, vapours or explosives in air, sensors of air quality and many other converters of different physical quantities can be used as sources of the control signal. If the fan is overloaded, the thermo-contacts TK, TK will disconnect due to overheating of the motor winding. The system will switch the power supply of the overloaded fan off, and the failure will be signalled by an LED on the OSX control panel. After cooling down, the motor is not automatically restarted. The failure must be confirmed by pressing the separate unblocking button on the OSX control panel for each fan. As most similar installations can vary from case to case, it is advisable to consult the operating conditions with the manufacturer.

FIGURE 11 – FAN CONNECTION

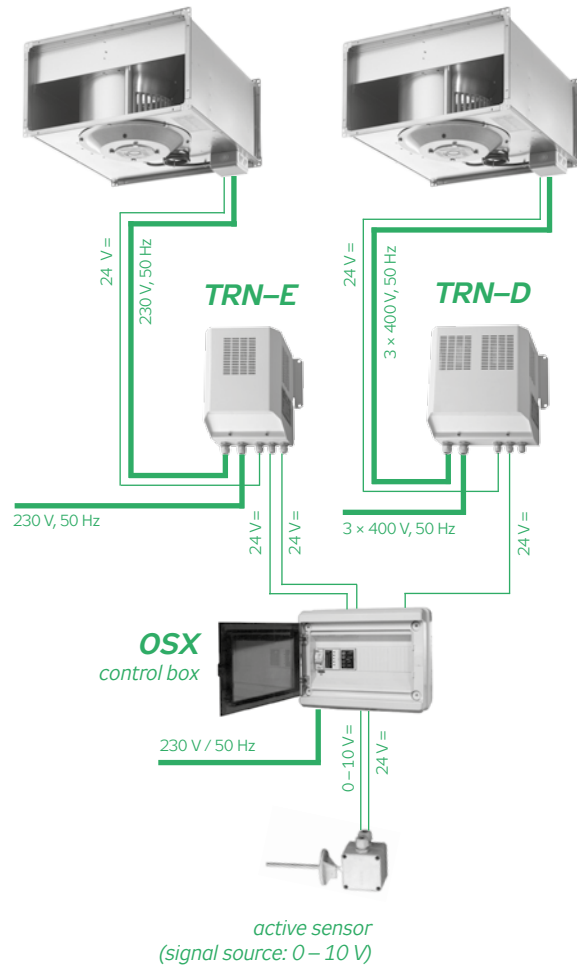

RP
 RQ
 RO
 RE
 RF
 RPH
 EX
 TR..
 EO..
 VO
 SUMX
 CHV
 CHF
 HRV
 HRZ
 PRI

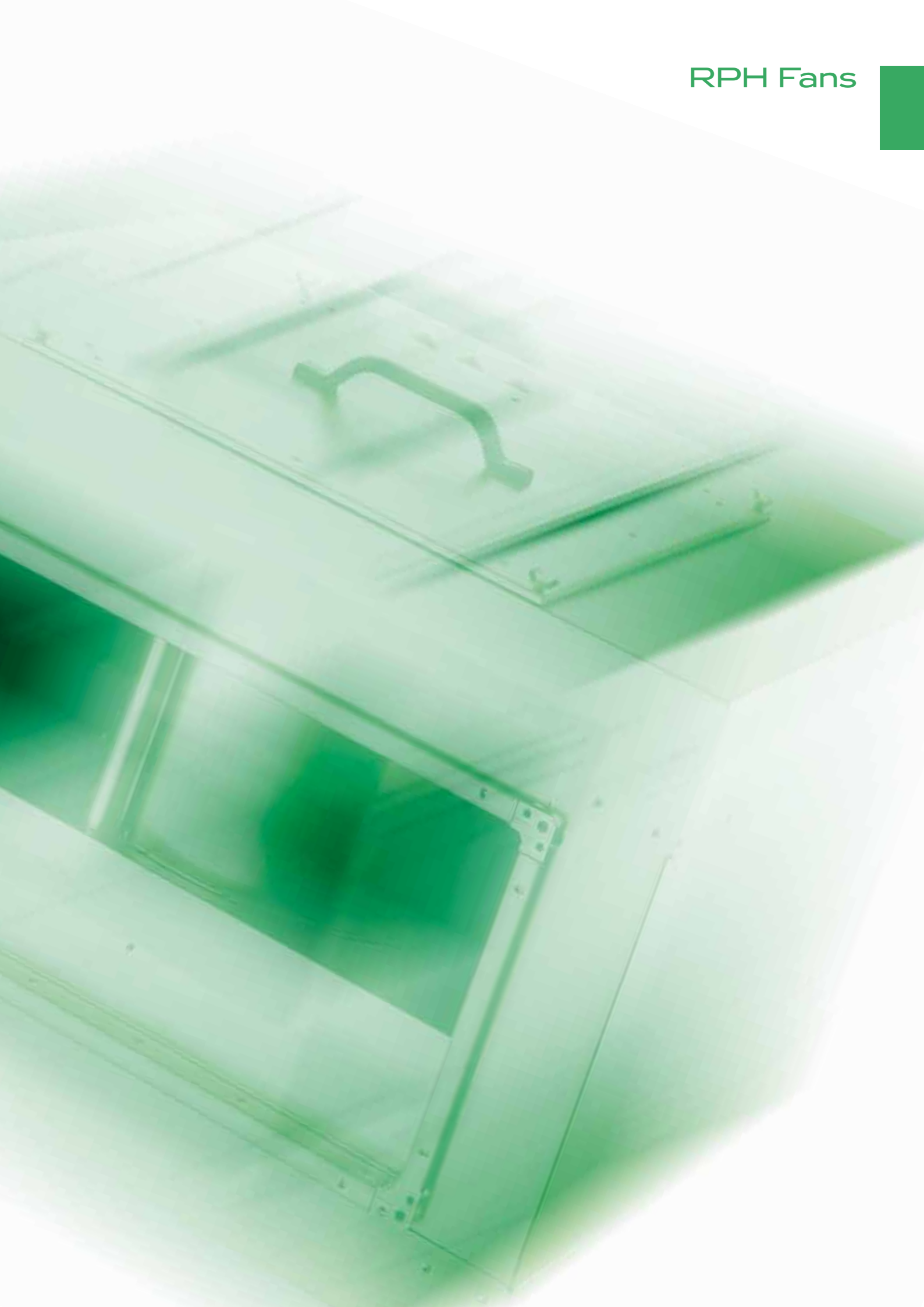

FAN USE

Fully controlled, low-pressure RPH sound-insulated radial fans intended for the square duct can be universally used for complex air-conditioning, from simple venting installations to sophisticated air-handling systems. By noise insulation is meant the reduction of the acoustic output level in the direction of "the surroundings". In order to reduce the acoustic output level in the direction of "intake" and "exhaust", it is necessary to supplement the fan with noise-insulated attenuators. Ideally, they can be used along with other components of the Vento modular system which ensure inter-compatibility and balanced parameters.

OPERATING CONDITIONS, POSITION

These fans are designed for indoor applications. Outdoor applications are possible providing sufficient roofing is ensured. They are designed to transport air without solid, fibrous, sticky, aggressive, respectively explosive impurities. For outdoor applications it is necessary to finish the fans with a protective coating (except rating plates). The transported air must be free of corrosive chemicals or chemicals aggressive to zinc and/or aluminium. Acceptable temperature of transported air can range from $-30\text{ }^{\circ}\text{C}$ to $+40\text{ }^{\circ}\text{C}$, and with certain types up to $+70\text{ }^{\circ}\text{C}$. The maximum nominal values for each fan are included in table 4. The RPH fans can work in any position. When positioned under the ceiling, it is advisable to situate the fan with the motor cup directed downwards to easy access to the motor terminal box. However, if the transported air is oversaturated with moisture or if the risk of intensive steam condensation inside the fan exists, it is better to situate the fan's cup upwards. We recommend adding a 1–1.5 m long piece of straight duct to the fan's outlet to reduce pressure losses in an assembly.

ROZMĚROVÁ ŘADA

RPH fans are manufactured in a range of nine sizes according to the $A \times B$ dimensions of the connecting flange. Several fans differing in the number of motor poles are available for each size. When planning the fan for the required air flow and pressure, the following general rule is applied; the larger fans with higher number of poles reach the required parameters at lower RPM, which results in lower noise and longer service life. Fans with higher number of poles also have lower air velocity in the cross section, which results in lower pressure losses in the duct and accessories, however, at higher investment costs. The standard dimensional and performance range of single-phase and three-phase RPH fans enables the designers to optimize all parameters for air flow up to $11,700\text{ m}^3$ per hour.

MATERIALS

The external casing and connecting flanges of RPH fans are made of galvanized steel sheets ($\text{Zn } 275\text{ g/m}^2$). Impeller blades – with forward curved blades (all fan types excluding 100-50/56-4D) are made of galvanized steel sheets, 100-50/56-4D has impeller blades with backward curved blades and it is made of painted steel. Diffusers are made of aluminium, motors are made of aluminium alloys, copper and plastic. The noise insulation is made of non-combustible, rot-resistant, waterproof mineral wool.

FIG. 1 – DIMENSIONS

A × B [mm]	
400-200	40-20
500-250	50-25
500-300	50-30
600-300	60-30
600-350	60-35
700-400	70-40
800-500	80-50
900-500	90-50
1000-500	100-50

MOTORS

The external casing and connecting flanges of RPH fans are made of galvanized steel sheets ($\text{Zn } 275\text{ g/m}^2$). Impeller blades – with forward curved blades (all fan types excluding 100-50/56-4D) are made of galvanized steel sheets, 100-50/56-4D has impeller blades with backward curved blades and it is made of painted steel. Diffusers are made of aluminium, motors are made of aluminium alloys, copper and plastic. The noise insulation is made of non-combustible, rot-resistant, waterproof mineral wool.

ELECTRICAL EQUIPMENT

Single-phase motors are equipped with a starting capacitor which is mounted on the fan casing. The wiring is terminated in a terminal box of IP 40 protection degree under covering panel. For wiring diagrams, refer to the section "The Wiring".

MOTOR PROTECTION

As standard, permanent monitoring of the internal motor temperature is used in all motors. The limit temperature is monitored by thermal contacts (TK-thermo-contacts) situated in the motor winding. The thermo-contacts are miniature thermal tripping elements which after being connected to the protective contactor circuit protect the motor against overheating (damage) due to phase failure, forced motor braking, current protection circuit breakdown or excessive temperature of transported air. Thermal protection by means of thermo-contacts is comprehensive and reliable providing they are correctly connected. This type of protection is essential especially for speed controlled and frequently started motors and motors highly thermally loaded by hot transported air.

Therefore, the fan motors cannot be protected by conventional thermal protection ensured by the motor overcurrent protective elements!

Maximum thermo-contact permanent loading is 1.2 A at 250V / 50 Hz ($\cos \varphi 0,6$) je 1,2 A (resp. 2 A respectively $\cos \varphi 1,0$).

FAN OUTPUT CONTROL

The output of all RPH fans can be fully controlled by changing the speed. The fan's speed is changed depending on the voltage at the motor terminals. The fan parameter tables contain voltage controllers corresponding to each fan. Generally, several types of control can be used with fans. However, voltage control is the most suitable for RPH fans.

Five Stage Voltage Control (transformer type)

Voltage control of single-phase and three-phase RPH fans is the most suitable, technically as well as operationally. There is no interference, humming, squeaking or vibration of the motor.

RPH fans can be steplessly controlled providing the change in voltage is stepless. In practice, stage voltage controllers are usually used. TRN stage voltage controllers can control the fan output in five stages in 20% steps, refer to Table # 1 showing the correlation between the input voltage and selected stage of the controller for single-phase and three-phase motors.

RPH fan motors can be operated within a range of approx. from 25 % to 110 % of the rated voltage.

All values respect the 400/230 V power supply system. The range of TRN controllers is intended to control the speed, respectively output, of all Vento fans. The possibility of remote control (by manual switch or by a switch in the control unit, respectively by automatic switching of five stages based on the external control signal of 0–10 V from the OSX control unit) is a significant feature of this product line.

This product line includes three single-phase and four three-phase TRN controllers. These controllers cover every type of Vento fan. Simplified TRR controllers can also be used; however, they do not provide protection function.

TABLE 1 – THE INPUT VOLTAGE AND CONTROLLER'S STAGE

MOTOR TYPE	CURVE CHARACTERISTICS – CONTROLLER'S STAGE				
	5	4	3	2	1
1 – phase	230 V	180 V	160 V	130 V	105 V
3 – phase	400 V	280 V	230 V	180 V	140 V

Stepless Electronic Control

Stepless electronic voltage control of the output is offered only with single-phase fans. The disadvantage of electronic control provided by PE 2,5 and PE 4 controllers is greater warming of motors. A partial disadvantage is also the fact that the designer does not have the possibility to exactly define for the user the stage of required output related to the load of the ventilated space.

Stepless control can be provided by means of frequency inverters, which must be fitted with a sine wave filters at the the output side. Appropriate inverter with sinusoidal filter can be supplied according to customer requirements.

PŘÍSLUŠENSTVÍ

RPH fans belong in the wide range of Vento modular venting and air-handling system components. Any air-handling set-up, from simple venting to sophisticated comfortable air-conditioning, can be created by selecting suitable elements. Universal duct RPH fans can be used along with a wide range of elements and accessories:

- KFD Bag Filters and KF3, KF5, KF7 Filter Inserts
- VFK Insert Air Filters and VF3 Filter Inserts
- VFT metal grease filters and spare VT3 cells
- DV Elastic Connections
- LKR, LKS, LKSX, and LKSF Regulating and Closing Dampers
- PK Pressure Dampers
- PZ Louvers
- TKU Splitter Attenuators
- VO Water Heaters
- SUMX Mixing Sets
- EO, EOS, EOSX Electric Heaters
- CHF Direct Coolers
- CHV Water Coolers
- HRV Plate Heat Exchangers
- SKX Circulating Air Mixing Chambers
- VLH humidification chambers and steam humidifiers
- Control units and sensors
- TRN Controllers, ORe 5 controllers, TRRE, TRRD Controllers, or PE controllers
- STE, STD Protecting Relays

FAN DESCRIPTION AND DESIGNATION

The key for type designation of RPH fans in projects and orders is defined in figure # 2.

For example, type designation RPH 60-30/28-4 D specifies the type of fan, impeller and motor.

FIGURE 2 – TYPE DESIGNATION OF RPH FANS

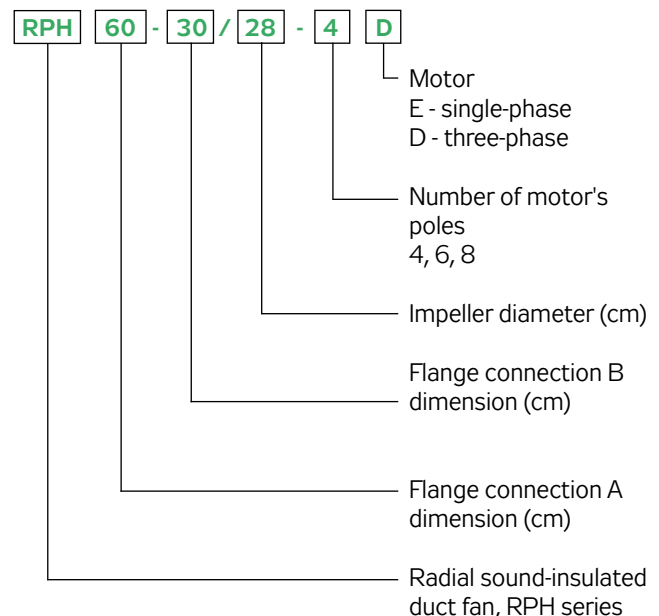

RP
RQ
RO
RE
RF
RPH
EX
TR..
EO..
VO
SUMX
CHV
CHF
HRV
HRZ
PRI

The most used names of the fan's individual parts and structure assemblies are shown on figure # 3.

DIMENSIONS, WEIGHTS AND PERFORMANCE

For important dimensions of RPH fans, refer to Figure #4 and Table #3. For basic parameters refer to table #4.

FIGURE 3 – RPH FAN DESCRIPTION

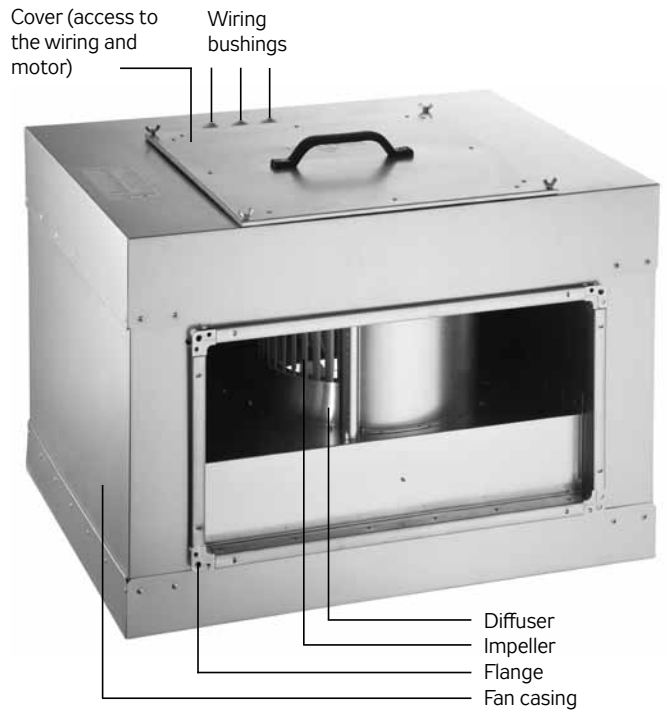

TABLE 3 – FAN DIMENSIONS

FAN TYPE	DIMENSIONS IN MM								
	A	B	C	D	E	F	G	H	I
RPH 40-20/20..	400	200	420	220	440	240	475	500	620
RPH 50-25/22..	500	250	520	270	540	290	525	530	720
RPH 50-30/25..	500	300	520	320	540	340	575	565	720
RPH 60-30/28..	600	300	620	320	640	340	575	642	820
RPH 60-35/31..	600	350	620	370	640	390	625	720	820
RPH 70-40/35..	700	400	720	420	740	440	675	780	920
RPH 80-50/40..	800	500	820	520	840	540	775	885	1020
RPH 90-50/45..	900	500	930	530	960	560	775	985	1120
RPH 100-50/45..	1000	500	1030	530	1060	560	775	985	1220
RPH 100-50/56..	1000	500	1030	530	1060	560	775	1173	1220

FIGURE 4 – FAN DIMENSIONAL DIAGRAM

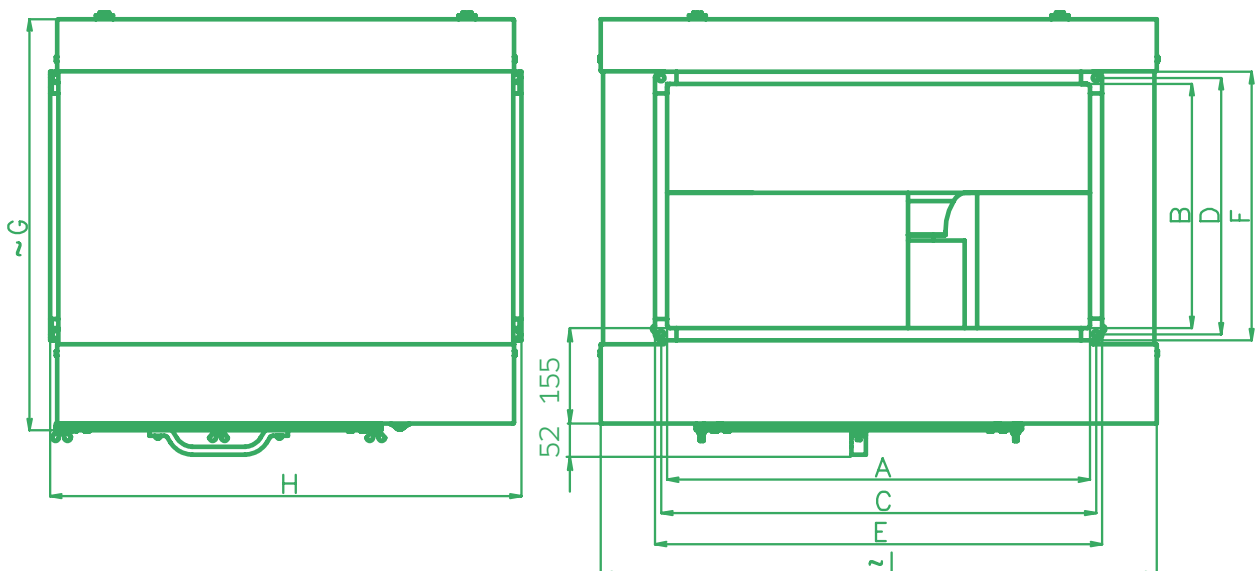

TABLE 4 – FAN BASIC PARAMETERS AND NOMINAL VALUES

Fan Type	V_{max}	$\Delta p_{t,max}$	$\Delta p_{s,min}$	n_{nom}	U_{nom}	P_{max}	I_{max}	t_{max}	C	Controller	m	ErP2015	
	m ³ /h	Pa	W	min ⁻¹	V	W	A	°C	µF	type	kg		
SINGLE-PHASE FANS													
RPH 40 - 20/20 - 4E	1200	233	0	1420	230	322	1,6	40	5	TRN 2E	36	✘	—
RPH 50 - 25/22 - 4E	1648	299	55	1420	230	548	2,3	40	8	TRN 4E	45	✘	—
RPH 50 - 30/25 - 4E	2305	360	0	1380	230	831	3,68	55	14	TRN 4E	53	✘	—
RPH 60 - 30/28 - 4E	2496	469	152	1400	230	1046	5,1	40	16	TRN 7E	68	✘	—
THREE-PHASE FANS													
RPH 40 - 20/20 - 4D	1292	236	0	1420	400	291	0,5	70	-	TRN 2D	36	✓	η=32.2% (statA) N=44.0 (N44)
RPH 50 - 25/22 - 6D	1376	137	0	940	400	222	0,46	55	-	TRN 2D	43	✓	N/A (P1 < 125 W)
RPH 50 - 25/22 - 4D	1937	309	0	1440	400	590	1	40	-	TRN 2D	45	✘	—
RPH 50 - 30/25 - 6D	1811	163	0	940	400	356	0,69	55	-	TRN 2D	49	✘	—
RPH 50 - 30/25 - 4D	2576	414	0	1450	400	1004	1,97	50	-	TRN 2D	52	✘	—
RPH 60 - 30/28 - 6D	2531	239	0	960	400	575	1,28	55	-	TRN 2D	62	✘	—
RPH 60 - 30/28 - 4D	3178	469	0	1450	400	1397	2,38	40	-	TRN 4D	68	✓	η=39.2% (statA) N=47.1 (N44)
RPH 60 - 35/31 - 6D	3687	281	0	910	400	948	1,86	40	-	TRN 2D	72	✘	—
RPH 60 - 35/31 - 4D	4512	617	136	1440	400	2464	4,1	40	-	TRN 7 D	80	✓	η=38.8% (statA) N=45.9 (N44)
RPH 70 - 40/35 - 8D	3669	216	0	670	400	642	1,38	55	-	TRN 2D	93	✘	—
RPH 70 - 40/35 - 6D	4032	378	151	920	400	1096	2	40	-	TRN 2D	92	✓	η=36.6% (statA) N=44.0 (N44)
RPH 70 - 40/35 - 4D	5981	806	340	1440	400	3527	6	40	-	TRN 7D	110	✓	η=41.2% (statA) N=46.3 (N44)
RPH 80 - 50/40 - 8D	4720	298	0	700	400	1230	2,29	55	-	TRN 4D	118	✓	η=37.3% (statA) N=45.6 (N44)
RPH 80 - 50/40 - 6D	7357	496	0	960	400	2824	5,11	50	-	TRN 7D	132	✓	η=42.2% (statA) N=48.2 (N44)
RPH 80 - 50/40 - 4D	6831	1040	683	1410	400	4919	8,1	40	-	TRN 9D	139	✓	η=44.4% (statA) N=47.9 (N44)
RPH 90 - 50/45 - 4D	6558	1498	1014	1260	400	4919	8,3	55	-	TRN 9D	168	✘	—
RPH 90 - 50/45 - 6D	9200	667	90	930	400	3780	6,8	55	-	TRN 7D	168	✓	η=42.3% (statA) N=47.3 (N44)
RPH 90 - 50/45 - 8D	7810	386	0	690	400	1892	3,88	55	-	TRN 4D	165	✓	η=38.7% (statA) N=45.7 (N44)
RPH 100 - 50/45 - 4D	6558	1498	1014	1260	400	4919	8,3	55	-	TRN 9D	177	✘	—
RPH 100 - 50/45 - 6D	9200	667	90	930	400	3780	6,8	55	-	TRN 7D	177	✓	η=42.3% (statA) N=47.3 (N44)
RPH 100 - 50/45 - 8D	7810	386	0	690	400	1892	3,88	55	-	TRN 4D	174	✓	η=38.7% (statA) N=45.7 (N44)
RPH 100 - 50/56 - 4D	11731	1039	0	1383	400	3205	5,5	50	-	TRN 7D	206	✓	η=56.1% (statA) N=61.7 (N61)

SYMBOLS USED IN TABLE 4:

V_{max} maximum air flow rate
 n fan speed measured at the highest efficiency working point (5b),
rounded to tens
 U nominal power supply voltage of the motor without control
(all values in the table are to this voltage)
 P_{max} electric motor maximal power output
 I_{max} maximum phase current at voltage U
(this value must be checked)

t_{max} maximum permissible transported air temperature at air flow V_{max} .
 C capacitor capacity with single-phase fans
FM. frequency inverter
 m weight of the fan ($\pm 10\%$)
ErP2015 Fan compliance with the requirements of Regulation 2009/125/EC (NOT compliant fans must not be used within EU region)

DATA SECTION

Graph 1 enables quick selection of a suitable fan and alternate comparison of RPH fans. Only the highest characteristics of each fan at nominal supply voltage, i.e. without a controller or with a controller set to five stage, are included in this graph.

The Data Section of the catalogue contains all important information and measured data of RPH fans.

The noise parameters "levels of acoustic output into the intake" and "levels of acoustic output into the exhaust" are measured according to the Czech norm ISO 3743-2. The noise parameters "levels of acoustic output into the surroundings" are calculated from the values for acoustic output measured according to EN ISO 11546-1. The output characteristics of the fans are measured according to the norms DIN 24 163 and AMCA Standard 210-74..

EXAMPLE AND EXPLANATIONS OF FAN DATA

RPH 40-20/20-4D		3x 400 V	50 Hz
Power supply	Y		291
Max. electric input	P_{max}	[W]	0.50
Max. current (5c)	I_{max}	[A]	1420
Mean speed	n	[min ⁻¹]	-
Capacitor	C	[F]	70
Max. working temp.	t_{max}	[°C]	1292
Air flow max.	V_{max}	[m ³ /h]	236
Total pressure max.	$\Delta p_{t,max}$	[Pa]	0
Static pressure min. (5c)	$\Delta p_{s,min}$	[Pa]	12.8
Weight	m	[kg]	TRN 2D
Five-stage controller	type		STD
Protecting relay	type		

The meaning of individual lines is as follows:

- 1 Value of nominal power supply voltage
- 2 Maximum power input of the motor at working point 5c.
- 3 Maximum current at nominal voltage at working point 5c.
- 4 Mean speed, rounded to tens, measured at working point 5b.
- 5 Capacitor capacity with single-phase fans.
- 6 Maximum permissible transported air temperature.
- 7 Maximum air flow at working point 5c.
- 8 Maximum total pressure between points 5a–5c
- 9 Minimum permissible static pressure at point 5c.
- 10 Total weight of the fan.
- 11 Recommended fan output controller.
- 12 Recommended protecting relay of the fan without controller and control unit.

GRAPH 1 – RPH FAN CHARACTERISTICS QUICK SELECTION

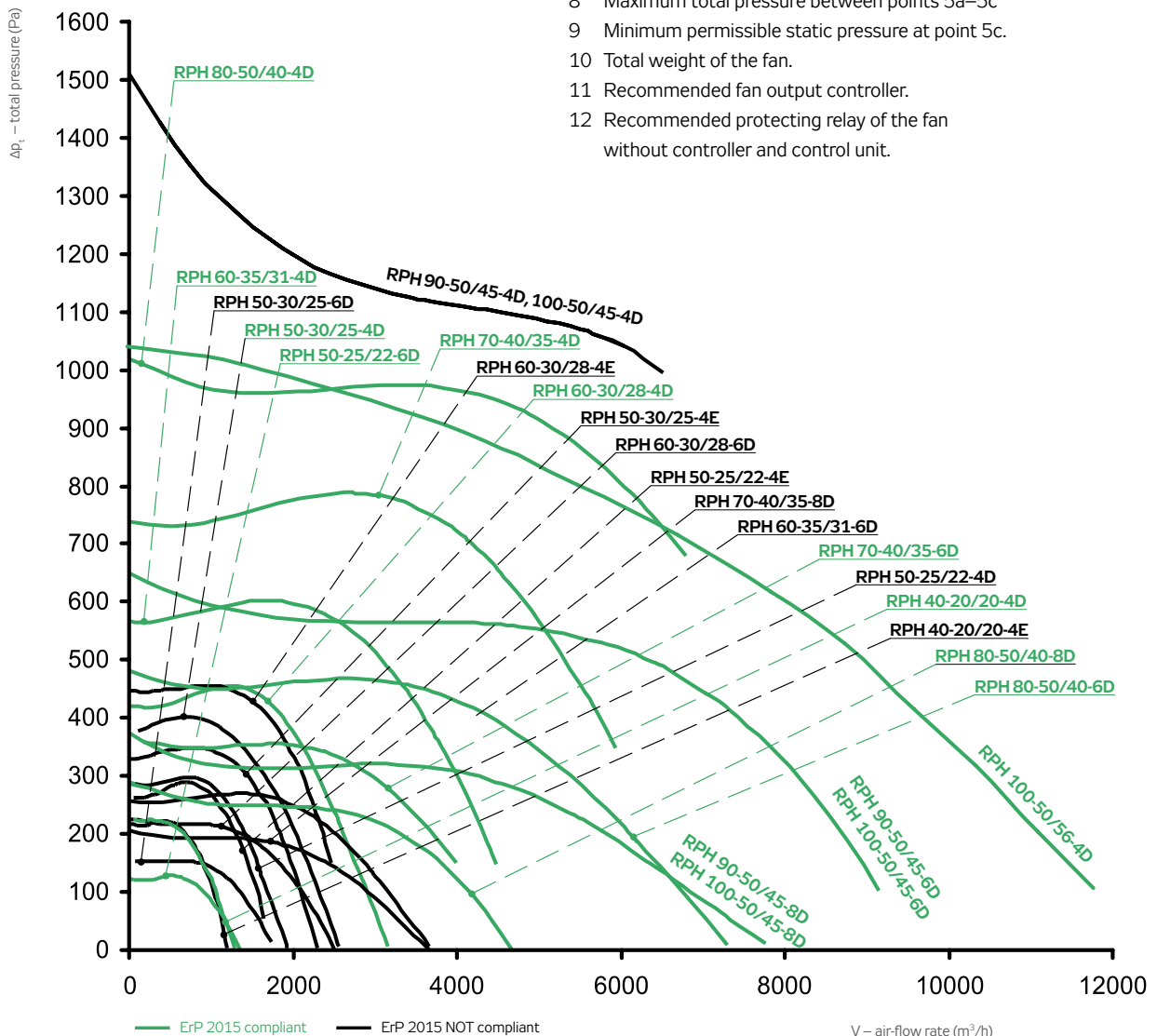

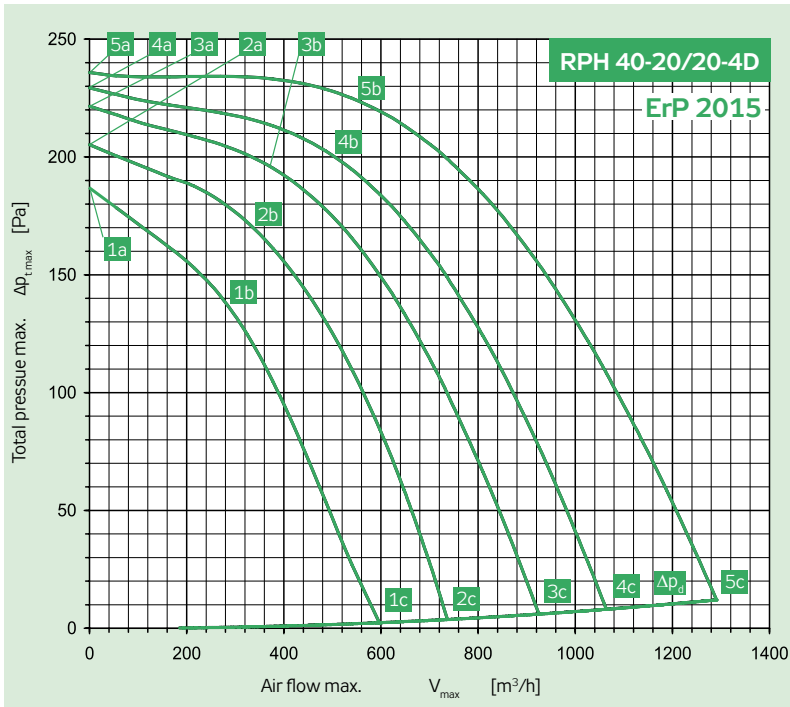

Power supply	Y	3× 400 V	50 Hz
Max. electric input	P_{max}	[W]	291
Max. current (5c)	I_{max}	[A]	0.50
Mean speed	n	[min ⁻¹]	1420
Capacitor	C	[F]	-
Max. working temp.	t_{max}	[°C]	70
Air flow max.	V_{max}	[m ³ /h]	1292
Total pressure max.	$\Delta p_{t,max}$	[Pa]	236
Static pressure min. (5c)	$\Delta p_{s,min}$	[Pa]	0
Weight	m	[kg]	36
Five-stage controller	type		TRN 2D
Protecting relay	type		STD

	Sání	Výtlak	Okolí
Bod	5b	5b	5b
Total sound power level LWA [dB(A)]			
L_{WA}	68	74	34
Sound power level LWAokt [dB(A)]			
125 Hz	54	55	32
250 Hz	61	62	20
500 Hz	59	65	10
1000 Hz	62	70	0
2000 Hz	62	68	0
4000 Hz	60	66	0
8000 Hz	53	58	42

Parameters in selected working points	5a	5b	5c	4a	4b	4c	3a	3b	3c	2a	2b	2c	1a	1b	1c
Voltage U [V]	400			280			230			180			140		
Current I [A]	0.30	0.32	0.50	0.19	0.26	0.50	0.17	0.22	0.47	0.17	0.22	0.43	0.15	0.22	0.37
Input power P [W]	71	125	291	49	98	215	41	71	170	41	60	120	31	49	81
Speed n [min ⁻¹]	1468	1418	1232	1438	1340	1011	1410	1319	892	1329	1226	734	1271	1094	590
Air flow V [m ³ /h]	0	561	1292	0	515	1061	0	383	923	0	345	734	0	296	592
Static pressure Δp_s [Pa]	236	222	0	229	198	0	222	193	0	205	166	0	187	132	0
Total pressure Δp_t [Pa]	236	224	12	229	200	8	222	194	6	205	167	4	187	133	2

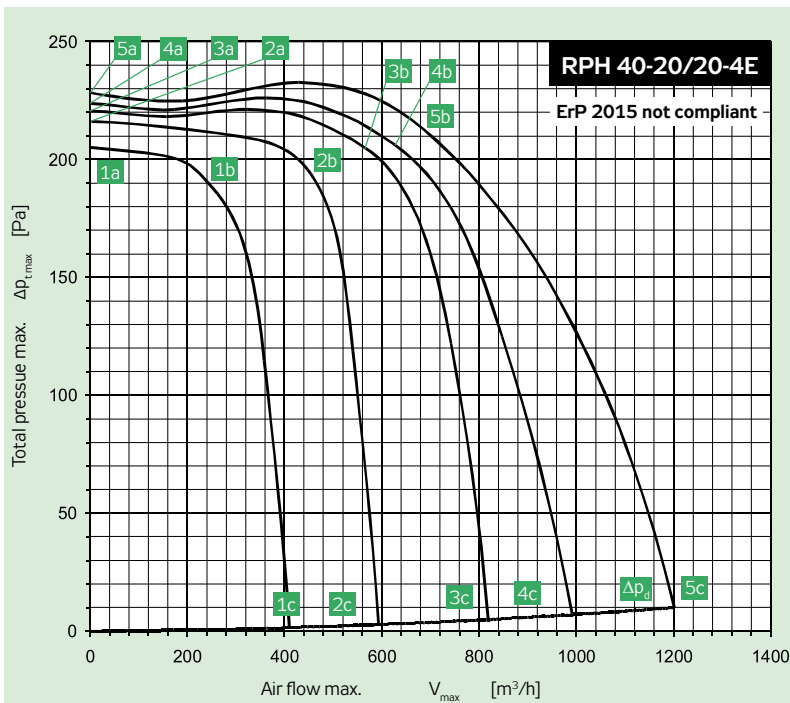

Power supply		230 V	50 Hz
Max. electric input	P_{max}	[W]	322
Max. current (5c)	I_{max}	[A]	1.60
Mean speed	n	[min ⁻¹]	1420
Capacitor	C	[F]	5
Max. working temp.	t_{max}	[°C]	40
Air flow max.	V_{max}	[m ³ /h]	1200
Total pressure max.	$\Delta p_{t,max}$	[Pa]	233
Static pressure min. (5c)	$\Delta p_{s,min}$	[Pa]	0
Weight	m	[kg]	36
Five-stage controller	type		TRN 2E
Protecting relay	type		STE

	Sání	Výtlak	Okolí
Bod	5b	5b	5b
Total sound power level LWA [dB(A)]			
L_{WA}	71	78	43
Sound power level LWAokt [dB(A)]			
125 Hz	57	56	36
250 Hz	66	71	42
500 Hz	63	68	24
1000 Hz	63	73	12
2000 Hz	64	71	0
4000 Hz	62	69	0
8000 Hz	53	61	0

Parameters in selected working points	5a	5b	5c	4a	4b	4c	3a	3b	3c	2a	2b	2c	1a	1b	1c
Voltage U [V]	230			180			160			130			105		
Current I [A]	0.99	1.08	1.6	0.56	0.81	1.58	0.49	0.78	1.46	0.46	0.72	1.17	0.48	0.57	0.95
Input power P [W]	144	197	322	91	141	237	77	122	189	62	92	122	49	56	75
Speed n [min ⁻¹]	1388	1416	1244	1459	1387	885	1449	1363	649	1428	1319	520	1391	1337	399
Air flow V [m ³ /h]	0	692	1200	0	629	851	0	576	607	0	459	470	0	254	358
Static pressure Δp_s [Pa]	228	210	0	224	204	0	221	200	0	216	190	0	205	187	0
Total pressure Δp_t [Pa]	228	213	10	224	207	5	221	202	3	216	191	2	205	187	1

RP
RQ
RO
RE
RF
RPH
EX
TR.
EO..
VO
SUMX
CHV
CHF
HRV
HRZ
PRI

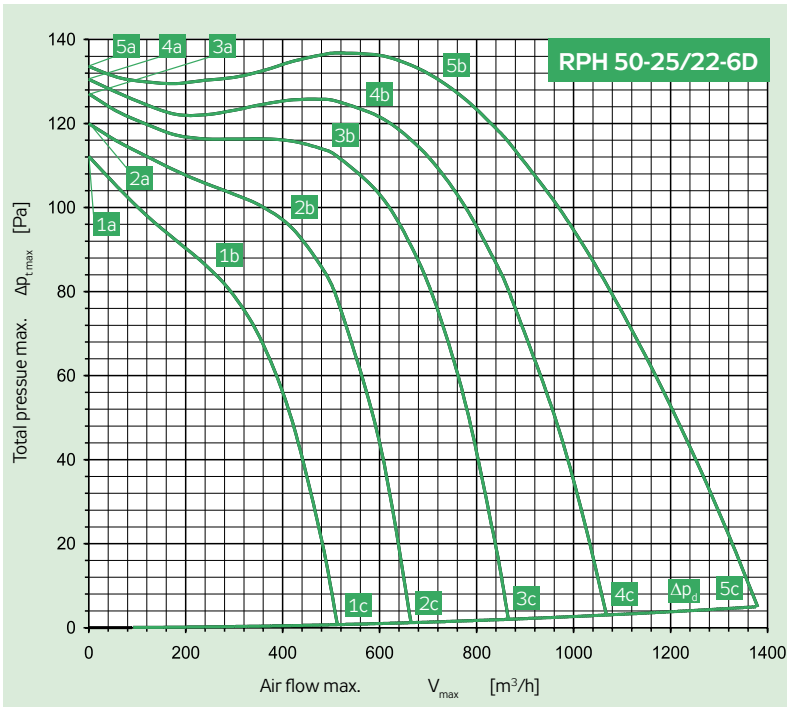

Power supply	Y	3 × 400 V	50 Hz
Max. electric input	P_{max}	[W]	222
Max. current (5c)	I_{max}	[A]	0.46
Mean speed	n	[min ⁻¹]	940
Capacitor	C	[F]	-
Max. working temp.	t_{max}	[°C]	55
Air flow max.	V_{max}	[m³/h]	1376
Total pressure max.	$\Delta p_{t,max}$	[Pa]	137
Static pressure min. (5c)	$\Delta p_{c,min}$	[Pa]	0
Weight	m	[kg]	43
Five-stage controller	type		TRN 2D
Protecting relay	type		STD

	Inlet	Outlet	Surrounding
Point	5b	5b	5b
Total sound power level LWA [dB(A)]			
L_{WA}	66	66	35
Sound power level LWAokt [dB(A)]			
125 Hz	58	52	33
250 Hz	62	57	30
500 Hz	57	59	18
1000 Hz	57	60	4
2000 Hz	57	59	0
4000 Hz	54	57	0
8000 Hz	44	48	0

Parameters in selected working points	5a	5b	5c	4a	4b	4c	3a	3b	3c	2a	2b	2c	1a	1b	1c
Voltage U [V]		400			280			230			180			140	
Current I [A]	0.30	0.33	0.46	0.20	0.24	0.42	0.17	0.21	0.38	0.15	0.20	0.33	0.14	0.17	0.27
Input power P [W]	62	110	222	36	68	151	31	56	111	26	44	73	22	30	45
Speed n [min ⁻¹]	986	943	825	971	912	650	954	878	548	921	823	420	873	795	347
Air flow V [m³/h]	0	735	1376	0	571	1064	0	490	864	0	399	665	0	259	511
Static pressure Δp_s [Pa]	134	130	0	131	123	0	127	113	0	120	96	0	112	85	0
Total pressure Δp_t [Pa]	134	132	5	131	124	3	127	114	2	120	96	1	112	85	1

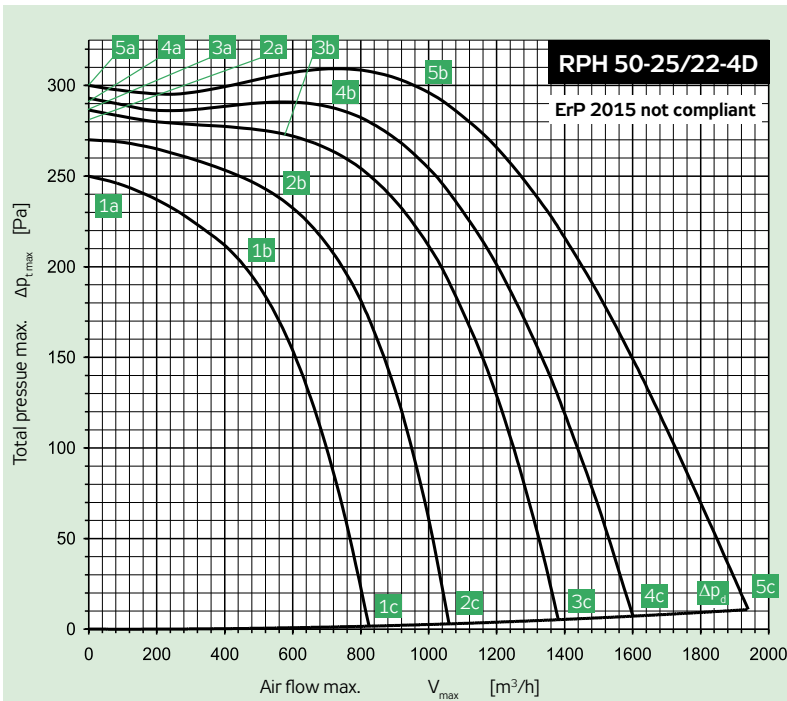

Power supply	Y	3 × 400 V	50 Hz
Max. electric input	P_{max}	[W]	590
Max. current (5c)	I_{max}	[A]	1.00
Mean speed	n	[min ⁻¹]	1440
Capacitor	C	[F]	-
Max. working temp.	t_{max}	[°C]	40
Air flow max.	V_{max}	[m³/h]	1937
Total pressure max.	$\Delta p_{t,max}$	[Pa]	309
Static pressure min. (5c)	$\Delta p_{c,min}$	[Pa]	0
Weight	m	[kg]	45
Five-stage controller	type		TRN 2D
Protecting relay	type		STD

	Sání	Výtlak	Okolí
Bod	5b	5b	5b
Total sound power level LWA [dB(A)]			
L_{WA}	72	78	42
Sound power level LWAokt [dB(A)]			
125 Hz	65	64	40
250 Hz	66	70	37
500 Hz	62	71	24
1000 Hz	62	73	10
2000 Hz	65	71	0
4000 Hz	62	69	0
8000 Hz	53	61	0

Parameters in selected working points	5a	5b	5c	4a	4b	4c	3a	3b	3c	2a	2b	2c	1a	1b	1c
Voltage U [V]		400			280			230			180			140	
Current I [A]	0.58	0.63	1.00	0.34	0.46	1.07	0.28	0.40	1.00	0.26	0.45	0.97	0.27	0.45	0.84
Input power P [W]	119	249	590	85	174	478	67	131	379	60	121	251	54	96	167
Speed n [min ⁻¹]	1485	1439	1306	1463	1400	1085	1448	1377	948	1409	1284	744	1353	1189	585
Air flow V [m³/h]	0	951	1937	0	715	1605	0	592	1379	0	567	1060	0	452	825
Static pressure Δp_s [Pa]	300	300	0	293	284	0	286	272	0	270	234	0	250	198	0
Total pressure Δp_t [Pa]	300	303	11	293	285	7	286	273	5	270	235	3	250	199	2

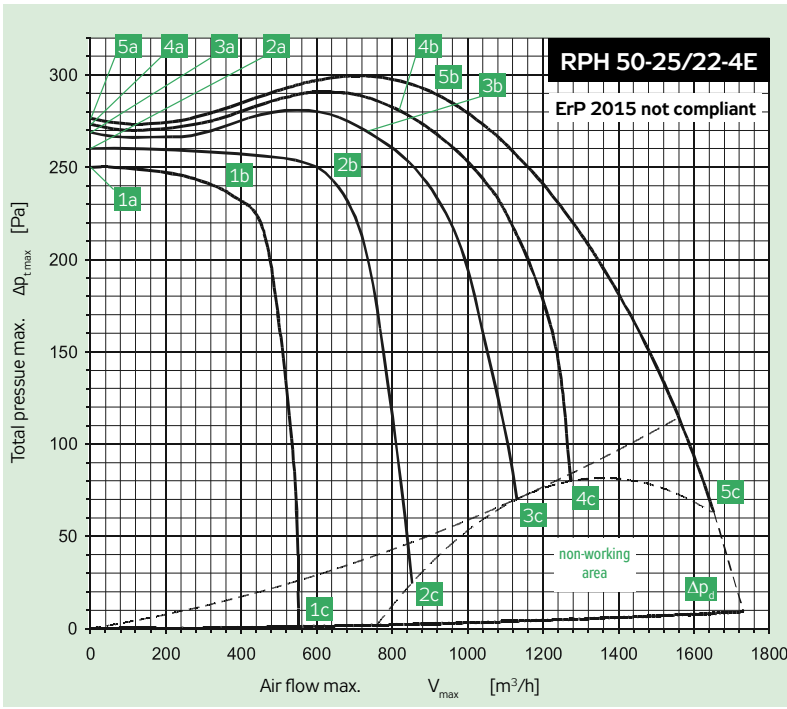

Power supply	230 V	50 Hz
Max. electric input	P_{max} [W]	499
Max. current (5c)	I_{max} [A]	2.30
Mean speed	n [min ⁻¹]	1420
Capacitor	C [F]	8
Max. working temp.	t_{max} [°C]	40
Air flow max.	V_{max} [m ³ /h]	1648
Total pressure max.	$\Delta p_{t,max}$ [Pa]	299
Static pressure min. (5c)	$\Delta p_{s,min}$ [Pa]	45
Weight	m [kg]	18.1
Five-stage controller	type	TRN 4E
Protecting relay	type	STE

	Sání	Výtlak	Okolí
Bod	5b	5b	5b
Total sound power level LWA [dB(A)]			
L_{WA}	73	77	44
Sound power level LWAokt [dB(A)]			
125 Hz	65	61	43
250 Hz	67	67	38
500 Hz	61	68	23
1000 Hz	64	72	11
2000 Hz	66	70	0
4000 Hz	64	69	0
8000 Hz	56	61	0

Parameters in selected working points	5a	5b	5c	4a	4b	4c	3a	3b	3c	2a	2b	2c	1a	1b	1c
Voltage U [V]	230			180			160			130			105		
Current I [A]	1.07	1.33	2.30	0.69	1.15	2.25	0.66	1.11	2.20	0.70	1.11	2.01	0.66	0.90	1.64
Input power P [W]	181	275	499	124	211	381	108	180	319	95	147	225	73	97	146
Speed n [min ⁻¹]	1471	1419	1259	1466	1398	1081	1456	1373	881	1426	1318	541	1399	1316	416
Air flow V [m ³ /h]	0	914	1648	0	818	1275	0	728	1128	0	614	845	0	350	557
Static pressure Δp_s [Pa]	277	288	55	273	280	75	269	270	70	260	244	25	250	231	0
Total pressure Δp_t [Pa]	277	290	63	273	282	80	269	272	73	260	245	27	250	231	1

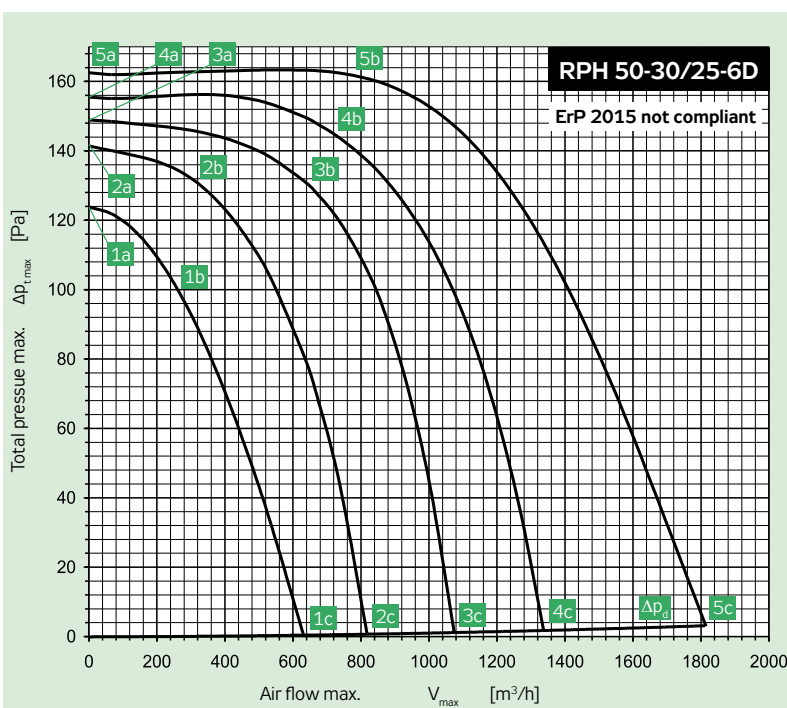

Power supply	Y	3 × 400 V	50 Hz
Max. electric input	P_{max} [W]	356	
Max. current (5c)	I_{max} [A]	0.69	
Mean speed	n [min ⁻¹]	940	
Capacitor	C [F]	-	
Max. working temp.	t_{max} [°C]	50	
Air flow max.	V_{max} [m ³ /h]	1811	
Total pressure max.	$\Delta p_{t,max}$ [Pa]	163	
Static pressure min. (5c)	$\Delta p_{s,min}$ [Pa]	0	
Weight	m [kg]	49	
Five-stage controller	type	TRN 2D	
Protecting relay	type	STD	

	Sání	Výtlak	Okolí
Bod	5b	5b	5b
Total sound power level LWA [dB(A)]			
L_{WA}	65	68	34
Sound power level LWAokt [dB(A)]			
125 Hz	62	55	31
250 Hz	54	56	30
500 Hz	54	61	18
1000 Hz	55	63	7
2000 Hz	57	62	0
4000 Hz	54	59	0
8000 Hz	43	48	0

Parameters in selected working points	5a	5b	5c	4a	4b	4c	3a	3b	3c	2a	2b	2c	1a	1b	1c
Voltage U [V]	400			280			230			180			140		
Current I [A]	0.42	0.45	0.69	0.30	0.36	0.65	0.25	0.33	0.57	0.21	0.25	0.47	0.21	0.24	0.38
Input power P [W]	76	133	356	49	104	223	42	88	157	37	51	98	33	41	59
Speed n [min ⁻¹]	977	943	770	959	891	593	942	844	481	912	861	377	840	772	306
Air flow V [m ³ /h]	0	776	1811	0	731	1334	0	652	1073	0	324	817	0	259	627
Static pressure Δp_s [Pa]	163	160	0	156	144	0	149	129	0	141	132	0	124	103	0
Total pressure Δp_t [Pa]	163	161	3	156	145	2	149	129	1	141	132	1	124	103	0

RP
RQ
RO
RE
RF
RPH
EX
TR.
EO..
VO
SUMX
CHV
CHF
HRV
HRZ
PRI

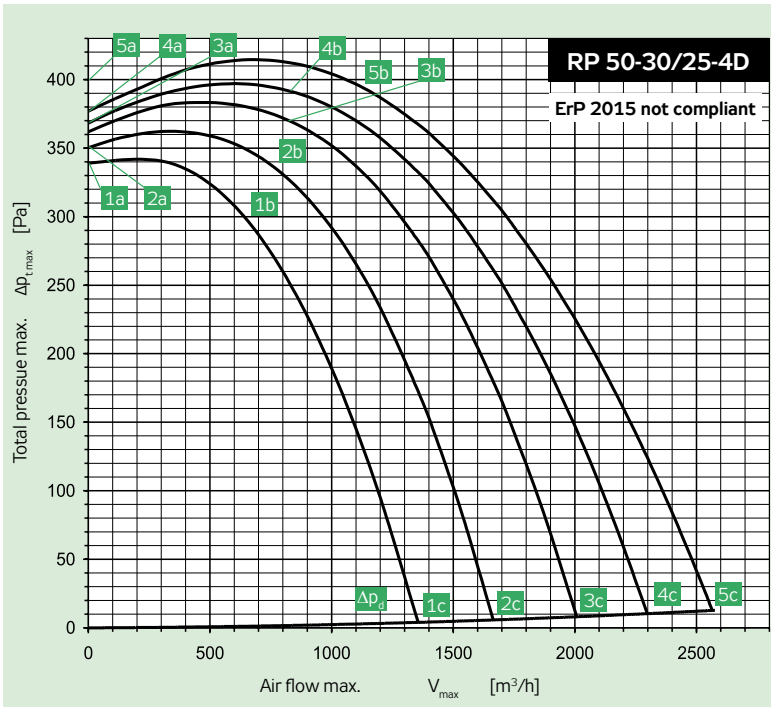

Power supply	Y	3× 400 V	50 Hz
Max. electric input	P_{max}	[W]	1004
Max. current (5c)	I_{max}	[A]	1.97
Mean speed	n	[min ⁻¹]	1450
Capacitor	C	[F]	-
Max. working temp.	t_{max}	[°C]	50
Air flow max.	V_{max}	[m ³ /h]	2576
Total pressure max.	$\Delta p_{t,max}$	[Pa]	414
Static pressure min. (5c)	$\Delta p_{c,min}$	[Pa]	0
Weight	m	[kg]	52
Five-stage controller	type		TRN 2D
Protecting relay	type		STD

	Sání	Výtlak	Okolí
Bod	5b	5b	5b
Total sound power level LWA [dB(A)]			
L_{WA}	74	79	44
Sound power level LWAokt [dB(A)]			
125 Hz	67	63	42
250 Hz	65	67	38
500 Hz	63	71	27
1000 Hz	67	74	18
2000 Hz	68	73	7
4000 Hz	65	71	0
8000 Hz	57	61	0

Parameters in selected working points	5a	5b	5c	4a	4b	4c	3a	3b	3c	2a	2b	2c	1a	1b	1c
Voltage U [V]		400			280			230			180			140	
Current I [A]	1.30	1.37	1.97	0.72	0.88	1.92	0.60	0.89	2.10	0.52	0.90	1.99	0.49	0.93	1.77
Input power P [W]	223	441	1004	133	271	803	120	268	700	114	246	519	97	205	358
Speed n [min ⁻¹]	1479	1454	1362	1469	1417	1216	1457	1387	1096	1434	1336	904	1390	1277	731
Air flow V [m ³ /h]	0	1110	2576	0	804	2306	0	828	2011	0	774	1666	0	679	1363
Static pressure Δp_s [Pa]	377	391	0	368	393	0	362	374	0	350	337	0	339	292	0
Total pressure Δp_t [Pa]	377	394	13	368	395	10	362	375	8	350	339	6	339	293	4

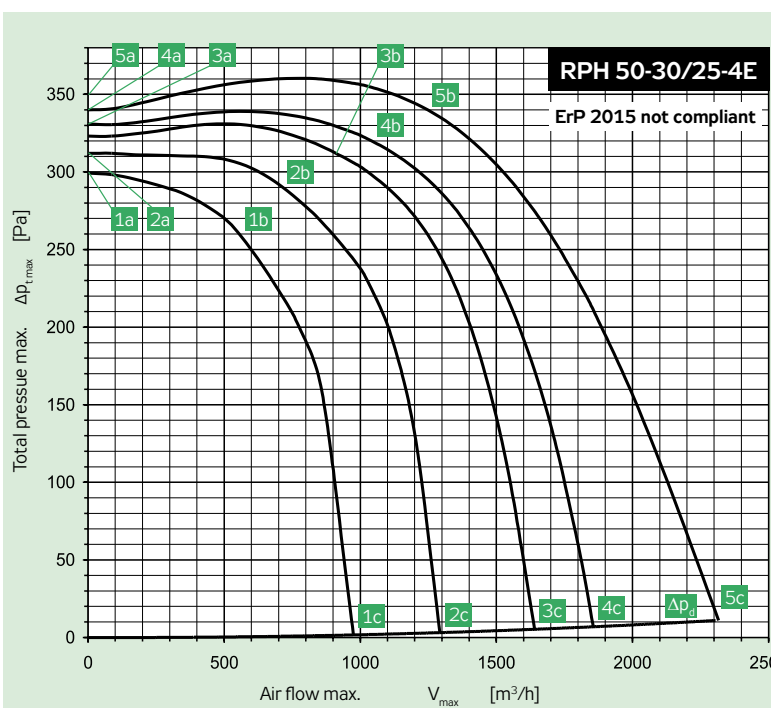

Power supply		230 V	50 Hz
Max. electric input	P_{max}	[W]	831
Max. current (5c)	I_{max}	[A]	3.68
Mean speed	n	[min ⁻¹]	1380
Capacitor	C	[F]	14
Max. working temp.	t_{max}	[°C]	50
Air flow max.	V_{max}	[m ³ /h]	2305
Total pressure max.	$\Delta p_{t,max}$	[Pa]	360
Static pressure min. (5c)	$\Delta p_{c,min}$	[Pa]	0
Weight	m	[kg]	53
Five-stage controller	type		TRN 4E
Protecting relay	type		STE

	Sání	Výtlak	Okolí
Bod	5b	5b	5b
Total sound power level LWA [dB(A)]			
L_{WA}	75	81	45
Sound power level LWAokt [dB(A)]			
125 Hz	66	64	43
250 Hz	66	67	39
500 Hz	65	73	27
1000 Hz	68	77	17
2000 Hz	69	74	4
4000 Hz	67	72	0
8000 Hz	58	62	0

Parameters in selected working points	5a	5b	5c	4a	4b	4c	3a	3b	3c	2a	2b	2c	1a	1b	1c
Voltage U [V]		230			180			160			130			105	
Current I [A]	1.23	1.94	3.68	1.11	1.87	3.64	1.09	1.76	3.51	1.02	1.62	3.07	0.98	1.55	2.64
Input power P [W]	270	444	831	199	339	632	174	286	539	135	215	381	107	167	262
Speed n [min ⁻¹]	1453	1382	1162	1436	1336	943	1424	1319	830	1402	1276	664	1368	1205	508
Air flow V [m ³ /h]	0	1230	2305	0	1041	1854	0	915	1638	0	722	1289	0	585	974
Static pressure Δp_s [Pa]	340	338	0	331	320	0	323	308	0	312	286	0	299	253	0
Total pressure Δp_t [Pa]	340	341	11	331	322	7	323	310	5	312	287	3	299	254	2

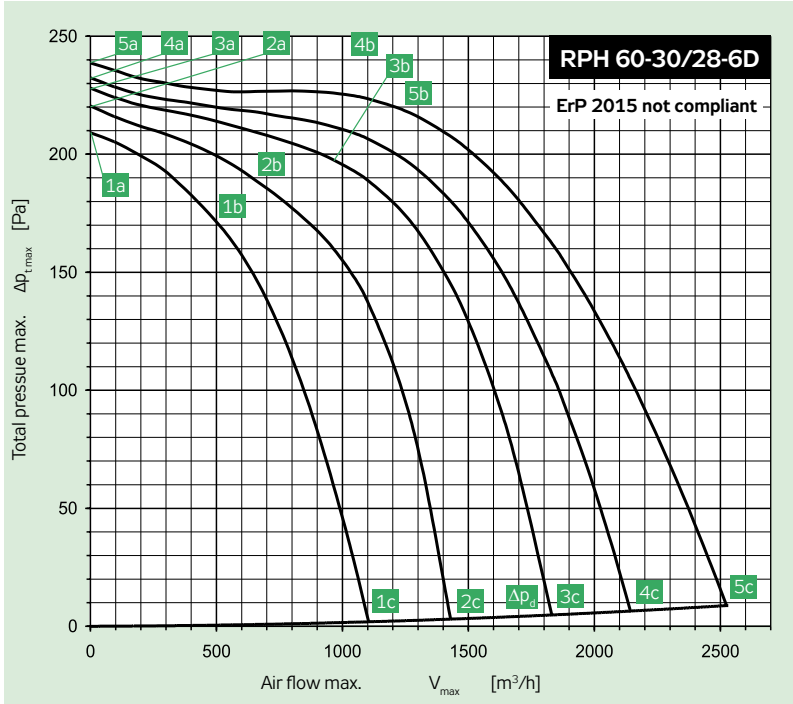

Power supply	Y	3 × 400 V	50 Hz
Max. electric input	P_{max}	[W]	575
Max. current (5c)	I_{max}	[A]	1.28
Mean speed	n	[min ⁻¹]	960
Capacitor	C	[F]	-
Max. working temp.	t_{max}	[°C]	55
Air flow max.	V_{max}	[m ³ /h]	2531
Total pressure max.	$\Delta p_{t,max}$	[Pa]	239
Static pressure min. (5c)	$\Delta p_{s,min}$	[Pa]	0
Weight	m	[kg]	62
Five-stage controller	type		TRN 2D
Protecting relay	type		STD

	Sání	Výtlak	Okolí
Bod	5b	5b	5b
Total sound power level LWA [dB(A)]			
L_{WA}	69	73	43
Sound power level LWAokt [dB(A)]			
125 Hz	64	61	43
250 Hz	60	62	35
500 Hz	62	68	23
1000 Hz	60	68	9
2000 Hz	60	65	0
4000 Hz	59	64	0
8000 Hz	48	53	0

Parameters in selected working points	5a	5b	5c	4a	4b	4c	3a	3b	3c	2a	2b	2c	1a	1b	1c
Voltage U [V]	400			280			230			180			140		
Current I [A]	0.30	0.32	0.50	0.19	0.26	0.50	0.17	0.22	0.47	0.17	0.22	0.43	0.15	0.22	0.37
Input power P [W]	71	125	291	49	98	215	41	71	170	41	60	120	31	49	81
Speed n [min ⁻¹]	1468	1418	1232	1438	1340	1011	1410	1319	892	1329	1226	734	1271	1094	590
Air flow V [m ³ /h]	0	561	1292	0	515	1061	0	383	923	0	345	734	0	296	592
Static pressure Δp_s [Pa]	236	222	0	229	198	0	222	193	0	205	166	0	187	132	0
Total pressure Δp_t [Pa]	236	224	12	229	200	8	222	194	6	205	167	4	187	133	2

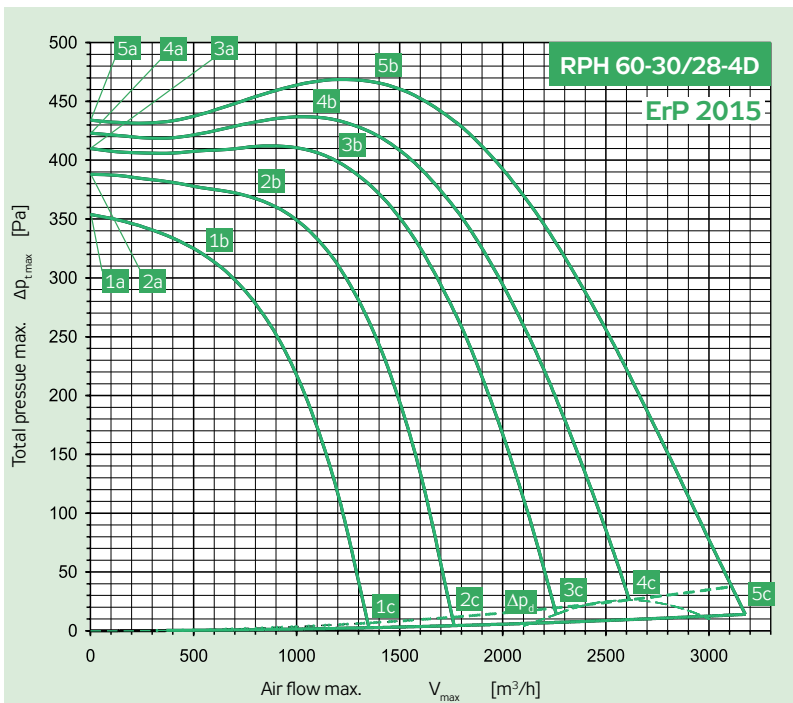

Power supply	Y	3 × 400 V	50 Hz
Max. electric input	P_{max}	[W]	1397
Max. current (5c)	I_{max}	[A]	2.38
Mean speed	n	[min ⁻¹]	1450
Capacitor	C	[F]	-
Max. working temp.	t_{max}	[°C]	40
Air flow max.	V_{max}	[m ³ /h]	3178
Total pressure max.	$\Delta p_{t,max}$	[Pa]	469
Static pressure min. (5c)	$\Delta p_{s,min}$	[Pa]	0
Weight	m	[kg]	68
Five-stage controller	type		TRN 4 D
Protecting relay	type		STD

	Sání	Výtlak	Okolí
Bod	5b	5b	5b
Total sound power level LWA [dB(A)]			
L_{WA}	78	83	46
Sound power level LWAokt [dB(A)]			
125 Hz	70	70	45
250 Hz	68	70	40
500 Hz	67	75	28
1000 Hz	72	78	19
2000 Hz	72	77	7
4000 Hz	69	75	0
8000 Hz	61	65	0

Parameters in selected working points	5a	5b	5c	4a	4b	4c	3a	3b	3c	2a	2b	2c	1a	1b	1c
Voltage U [V]	400			280			230			180			140		
Current I [A]	1.04	1.20	2.38	0.69	0.98	2.60	0.62	1.07	2.60	0.62	1.02	2.43	0.66	0.94	2.06
Input power P [W]	267	512	1397	201	380	1088	181	372	870	161	285	612	142	206	393
Speed n [min ⁻¹]	1483	1448	1307	1461	1409	1105	1438	1346	938	1404	1301	736	1344	1246	568
Air flow V [m ³ /h]	0	1330	3178	0	1083	2614	0	1162	2260	0	850	1766	0	552	1348
Static pressure Δp_s [Pa]	434	467	0	423	433	16	410	401	7	388	361	0	354	318	0
Total pressure Δp_t [Pa]	434	469	14	423	435	26	410	403	14	388	362	4	354	318	3

RP
RQ
RO
RE
RF
RPH
EX
TR.
EO..
VO
SUMX
CHV
CHF
HRV
HRZ
PRI

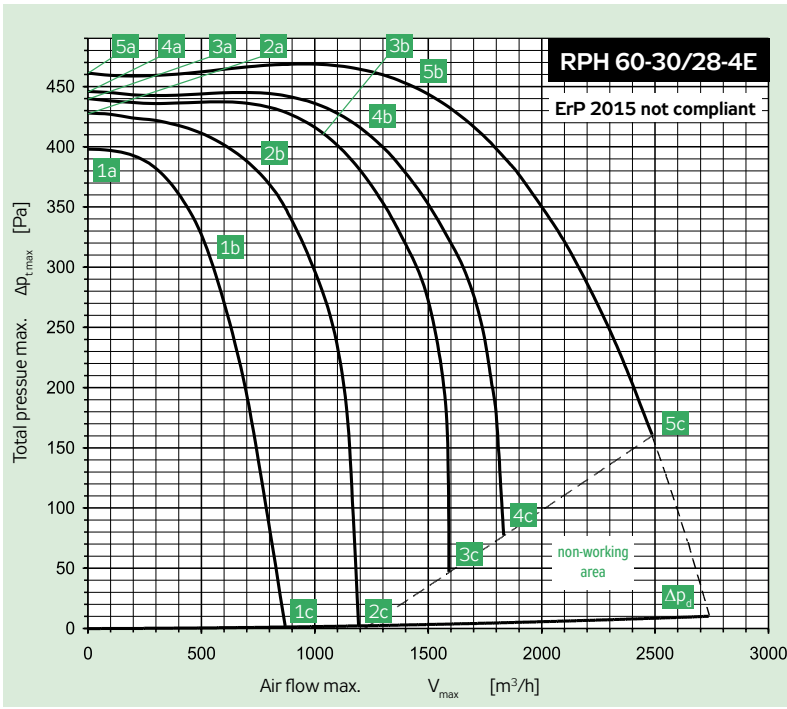

Power supply	230 V	50 Hz
Max. electric input	P_{max} [W]	1046
Max. current (5c)	I_{max} [A]	5.10
Mean speed	n [min^{-1}]	1400
Capacitor	C [F]	16
Max. working temp.	t_{max} [$^{\circ}C$]	40
Air flow max.	V_{max} [m^3/h]	2496
Total pressure max.	$\Delta p_{t,max}$ [Pa]	469
Static pressure min. (5c)	$\Delta p_{s,min}$ [Pa]	152
Weight	m [kg]	68
Five-stage controller	type	TRN 7E
Protecting relay	type	STE

	Sání	Výtlak	Okolí
Bod	5b	5b	5b
Total sound power level LWA [dB(A)]			
L_{WA}	77	83	49
Sound power level LWAokt [dB(A)]			
125 Hz	71	70	47
250 Hz	68	72	43
500 Hz	67	75	29
1000 Hz	69	78	17
2000 Hz	71	77	6
4000 Hz	67	74	0
8000 Hz	59	65	0

Parameters in selected working points	5a	5b	5c	4a	4b	4c	3a	3b	3c	2a	2b	2c	1a	1b	1c
Voltage U [V]	230			180			160			130			105		
Current I [A]	2.08	2.96	5.10	1.42	2.66	5.10	1.43	2.52	5.10	1.40	2.38	4.30	1.49	2.43	3.48
Input power P [W]	345	603	1046	247	452	775	225	389	681	185	294	457	158	234	294
Speed n [min^{-1}]	1465	1400	1237	1453	1353	898	1446	1345	760	1422	1288	499	1372	1157	385
Air flow V [m^3/h]	0	1465	2496	0	1222	1834	0	1054	1592	0	786	1218	0	584	882
Static pressure Δp_s [Pa]	461	439	152	446	411	72	440	406	43	428	369	0	398	294	0
Total pressure Δp_t [Pa]	461	442	161	446	413	77	440	408	47	428	370	2	398	294	1

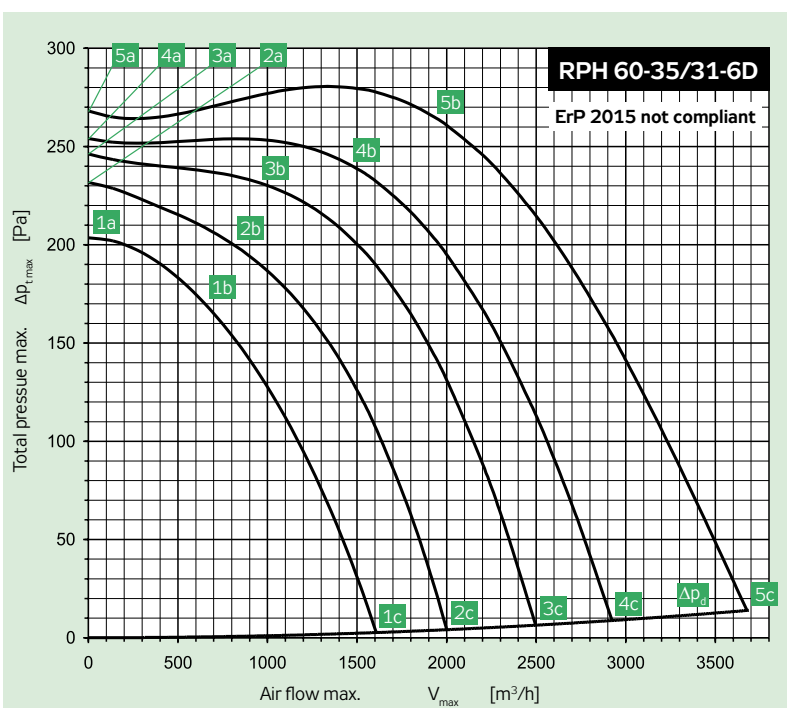

Power supply	Y	3 x 400 V	50 Hz
Max. electric input	P_{max} [W]	948	
Max. current (5c)	I_{max} [A]	1.86	
Mean speed	n [min^{-1}]	910	
Capacitor	C [F]	-	
Max. working temp.	t_{max} [$^{\circ}C$]	40	
Air flow max.	V_{max} [m^3/h]	3687	
Total pressure max.	$\Delta p_{t,max}$ [Pa]	281	
Static pressure min. (5c)	$\Delta p_{s,min}$ [Pa]	0	
Weight	m [kg]	72	
Five-stage controller	type	TRN 2D	
Protecting relay	type	STD	

	Sání	Výtlak	Okolí
Bod	5b	5b	5b
Total sound power level LWA [dB(A)]			
L_{WA}	70	75	45
Sound power level LWAokt [dB(A)]			
125 Hz	65	62	44
250 Hz	60	65	35
500 Hz	61	69	24
1000 Hz	62	69	11
2000 Hz	62	68	0
4000 Hz	61	67	0
8000 Hz	49	54	0

Parameters in selected working points	5a	5b	5c	4a	4b	4c	3a	3b	3c	2a	2b	2c	1a	1b	1c
Voltage U [V]	400			280			230			180			140		
Current I [A]	1.30	1.36	1.86	0.68	0.87	1.56	0.56	0.68	1.42	0.46	0.64	1.23	0.44	0.60	1.02
Input power P [W]	226	476	948	120	287	606	109	186	457	87	152	302	69	110	194
Speed n [min^{-1}]	977	908	754	959	866	609	940	878	532	909	808	429	866	755	355
Air flow V [m^3/h]	0	1946	3687	0	1470	2932	0	930	2494	0	873	2000	0	688	1603
Static pressure Δp_s [Pa]	268	260	0	254	235	0	246	233	0	232	198	0	204	169	0
Total pressure Δp_t [Pa]	268	264	14	254	237	9	246	234	6	232	199	4	204	169	3

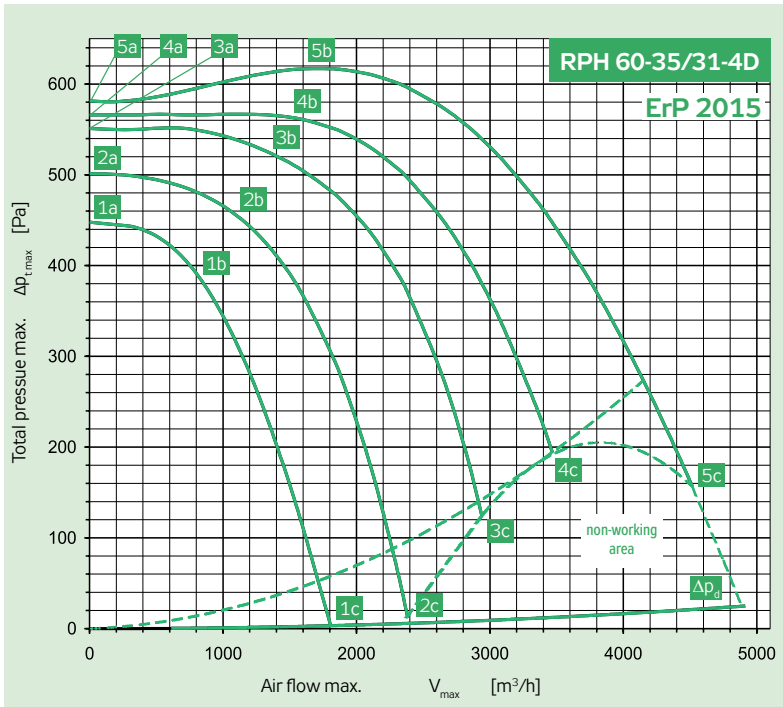

Power supply	Y	3× 400 V	50 Hz
Max. electric input	P_{max}	[W]	2464
Max. current (5c)	I_{max}	[A]	4.10
Mean speed	n	[min ⁻¹]	1440
Capacitor	C	[F]	-
Max. working temp.	t_{max}	[°C]	40
Air flow max.	V_{max}	[m ³ /h]	4512
Total pressure max.	$\Delta p_{t,max}$	[Pa]	617
Static pressure min. (5c)	$\Delta p_{s,min}$	[Pa]	136
Weight	m	[kg]	80
Five-stage controller	type		TRN 7D
Protecting relay	type		STD

	Sání	Výtlak	Okolí
Bod	5b	5b	5b
Total sound power level LWA [dB(A)]			
L_{WA}	78	83	53
Sound power level LWAokt [dB(A)]			
125 Hz	72	69	53
250 Hz	67	70	40
500 Hz	67	74	30
1000 Hz	71	78	19
2000 Hz	71	77	8
4000 Hz	69	76	0
8000 Hz	60	66	0

Parameters in selected working points	5a	5b	5c	4a	4b	4c	3a	3b	3c	2a	2b	2c	1a	1b	1c
Voltage U [V]	400			280			230			180			140		
Current I [A]	1.41	1.72	4.10	1.04	1.62	4.10	1.06	1.62	4.10	1.07	1.73	4.10	1.13	1.77	3.39
Input power P [W]	503	832	2464	351	666	1730	343	563	1374	295	484	1007	252	382	629
Speed n [min ⁻¹]	1474	1440	1252	1445	1383	1083	1418	1346	912	1381	1270	603	1321	1164	461
Air flow V [m ³ /h]	0	1754	4512	0	1533	3498	0	1324	2937	0	1064	2372	0	852	1808
Static pressure Δp_s [Pa]	581	614	136	566	561	182	551	524	115	501	460	6	448	383	0
Total pressure Δp_t [Pa]	581	617	157	566	563	194	551	526	124	501	461	12	448	384	3

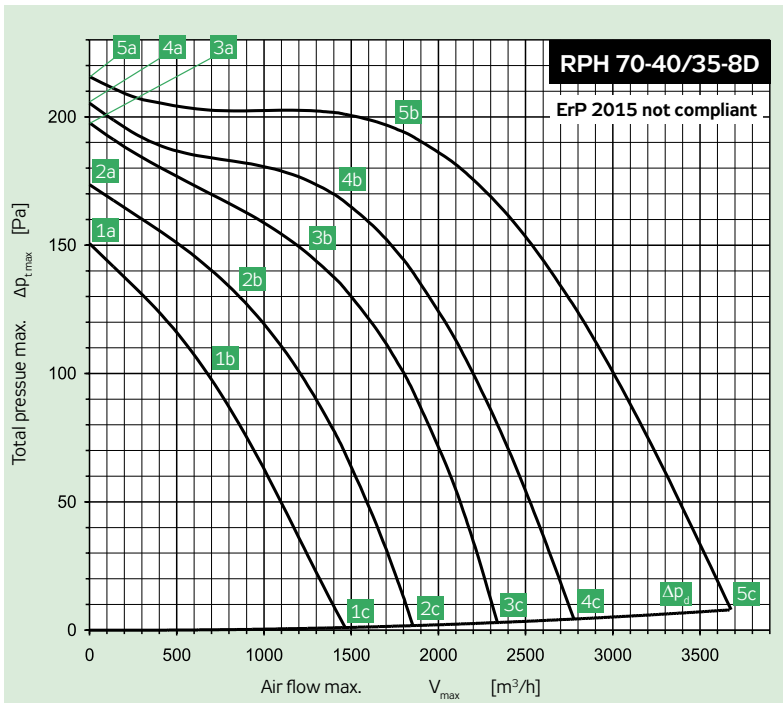

Power supply	Y	3× 400 V	50 Hz
Max. electric input	P_{max}	[W]	642
Max. current (5c)	I_{max}	[A]	1.38
Mean speed	n	[min ⁻¹]	670
Capacitor	C	[F]	-
Max. working temp.	t_{max}	[°C]	55
Air flow max.	V_{max}	[m ³ /h]	3669
Total pressure max.	$\Delta p_{t,max}$	[Pa]	216
Static pressure min. (5c)	$\Delta p_{s,min}$	[Pa]	0
Weight	m	[kg]	93
Five-stage controller	type		TRN 2D
Protecting relay	type		STD

	Sání	Výtlak	Okolí
Bod	5b	5b	5b
Total sound power level LWA [dB(A)]			
L_{WA}	68	72	45
Sound power level LWAokt [dB(A)]			
125 Hz	65	64	45
250 Hz	57	63	32
500 Hz	57	66	20
1000 Hz	59	65	6
2000 Hz	59	64	0
4000 Hz	58	63	0
8000 Hz	44	50	0

Parameters in selected working points	5a	5b	5c	4a	4b	4c	3a	3b	3c	2a	2b	2c	1a	1b	1c
Voltage U [V]	400			280			230			180			140		
Current I [A]	0.90	0.97	1.38	0.57	0.71	1.15	0.48	0.64	1.00	0.41	0.53	0.83	0.37	0.49	0.68
Input power P [W]	166	318	642	100	205	390	84	167	277	71	111	179	60	84	113
Speed n [min ⁻¹]	725	673	532	706	631	406	689	592	351	657	573	278	605	495	223
Air flow V [m ³ /h]	0	1815	3669	0	1404	2783	0	1252	2330	0	840	1850	0	697	1468
Static pressure Δp_s [Pa]	216	191	0	205	166	0	198	147	0	174	130	0	151	97	0
Total pressure Δp_t [Pa]	216	193	8	205	167	4	198	148	3	174	130	2	151	97	1

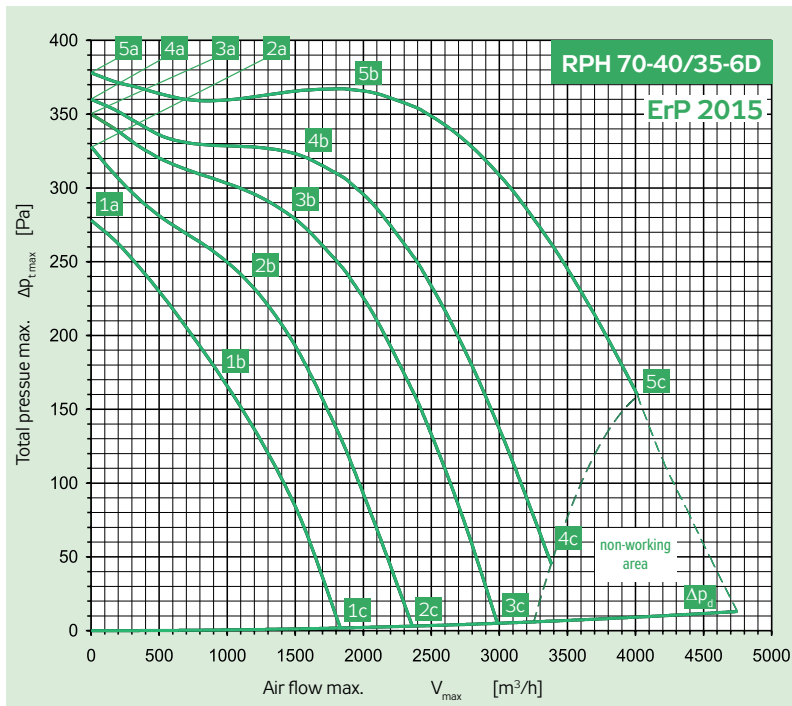

Power supply	Y	3 × 400 V	50 Hz
Max. electric input	P_{max}	[W]	1096
Max. current (5c)	I_{max}	[A]	2.00
Mean speed	n	[min ⁻¹]	920
Capacitor	C	[F]	-
Max. working temp.	t_{max}	[°C]	40
Air flow max.	V_{max}	[m ³ /h]	4032
Total pressure max.	$\Delta p_{t,max}$	[Pa]	378
Static pressure min. (5c)	$\Delta p_{c,min}$	[Pa]	151
Weight	m	[kg]	92
Five-stage controller	type		TRN 4D
Protecting relay	type		STD

	Sání	Výtlak	Okolí
Bod	73	79	68
Total sound power level LWA [dB(A)]			
L_{WA}	74	79	47
Sound power level LWAokt [dB(A)]			
125 Hz	68	70	46
250 Hz	64	69	37
500 Hz	63	73	27
1000 Hz	66	73	15
2000 Hz	64	71	5
4000 Hz	63	69	0
8000 Hz	52	58	0

EX

Parameters in selected working points	5a	5b	5c	4a	4b	4c	3a	3b	3c	2a	2b	2c	1a	1b	1c
Voltage U [V]		400			280			230			180			140	
Current I [A]	0.98	1.19	2.00	0.67	0.97	2.00	0.60	0.99	1.92	0.56	0.93	1.60	0.57	0.91	1.29
Input power P [W]	206	500	1096	153	350	784	138	316	600	127	239	392	112	182	243
Speed n [min ⁻¹]	977	922	779	954	872	566	935	813	424	896	756	354	835	644	285
Air flow V [m ³ /h]	0	1992	4032	0	1540	3366	0	1486	2995	0	1167	2384	0	992	1835
Static pressure Δp_s [Pa]	378	367	151	360	319	39	350	279	0	328	234	0	278	167	0
Total pressure Δp_t [Pa]	378	369	160	360	320	45	350	280	5	328	235	3	278	168	2

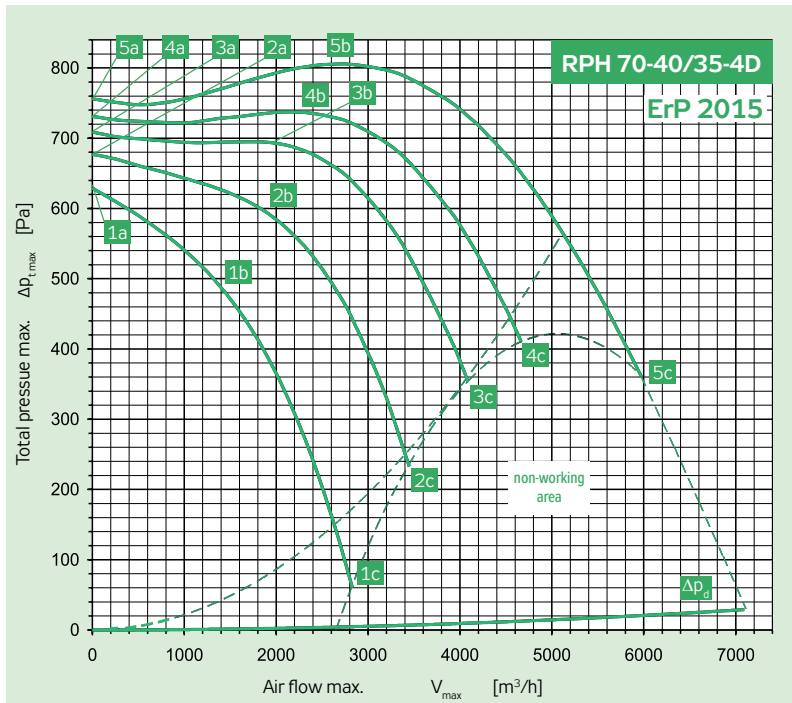

Power supply	Y	3 × 400 V	50 Hz
Max. electric input	P_{max}	[W]	3527
Max. current (5c)	I_{max}	[A]	6.00
Mean speed	n	[min ⁻¹]	1440
Capacitor	C	[F]	-
Max. working temp.	t_{max}	[°C]	40
Air flow max.	V_{max}	[m ³ /h]	5981
Total pressure max.	$\Delta p_{t,max}$	[Pa]	806
Static pressure min. (5c)	$\Delta p_{c,min}$	[Pa]	340
Weight	m	[kg]	110
Five-stage controller	type		TRN 7D
Protecting relay	type		STD

	Sání	Výtlak	Okolí
Bod	5b	5b	5b
Total sound power level LWA [dB(A)]			
L_{WA}	84	90	57
Sound power level LWAokt [dB(A)]			
125 Hz	77	79	56
250 Hz	75	78	47
500 Hz	74	83	37
1000 Hz	78	85	25
2000 Hz	78	83	12
4000 Hz	74	81	0
8000 Hz	64	70	0

HRV

HRZ

PRI

Parameters in selected working points	5a	5b	5c	4a	4b	4c	3a	3b	3c	2a	2b	2c	1a	1b	1c
Voltage U [V]		400			280			230			180			140	
Current I [A]	1.98	2.67	6.00	1.54	2.61	6.00	1.41	2.68	6.00	1.84	3.34	6.00	1.98	3.27	5.73
Input power P [W]	442	1231	3527	483	1065	2522	410	931	2028	503	924	1520	437	697	1055
Speed n [min ⁻¹]	1478	1442	1312	1457	1397	1189	1441	1355	1083	1387	1244	891	1327	1157	598
Air flow V [m ³ /h]	0	2577	5981	0	2148	4675	0	1979	4136	0	1977	3435	0	1410	2817
Static pressure Δp_s [Pa]	756	804	340	731	741	399	709	688	332	677	588	226	629	485	56
Total pressure Δp_t [Pa]	756	806	361	731	744	411	709	690	342	677	590	233	629	486	60

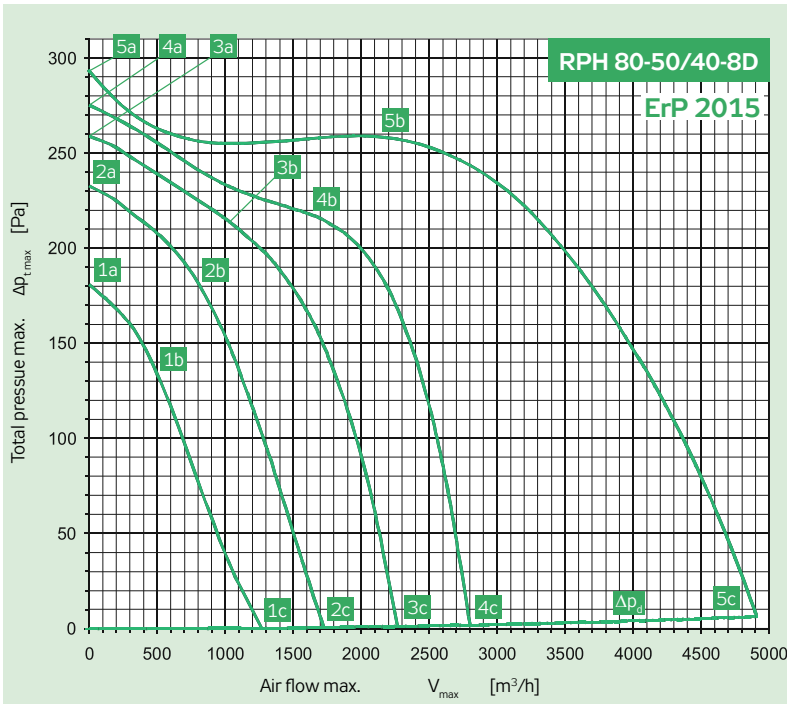

Power supply	Y	3× 400 V	50 Hz
Max. electric input	P_{max}	[W]	1230
Max. current (5c)	I_{max}	[A]	2.29
Mean speed	n	[min ⁻¹]	700
Capacitor	C	[F]	-
Max. working temp.	t_{max}	[°C]	55
Air flow max.	V_{max}	[m ³ /h]	4720
Total pressure max.	$\Delta p_{t,max}$	[Pa]	298
Static pressure min. (5c)	$\Delta p_{s,min}$	[Pa]	0
Weight	m	[kg]	118
Five-stage controller	type		TRN 4D
Protecting relay	type		STD

	Sání	Výtlak	Okolí
Bod	5b	5b	5b
Total sound power level LWA [dB(A)]			
L_{WA}	69	74	45
Sound power level LWAokt [dB(A)]			
125 Hz	62	61	44
250 Hz	60	63	35
500 Hz	59	68	22
1000 Hz	62	68	9
2000 Hz	62	68	0
4000 Hz	60	65	0
8000 Hz	48	52	0

Parameters in selected working points	5a	5b	5c	4a	4b	4c	3a	3b	3c	2a	2b	2c	1a	1b	1c
Voltage U [V]		400			280			230			180			140	
Current I [A]	0.88	1.05	2.29	0.56	0.85	1.80	0.53	0.72	1.52	0.54	0.70	1.24	0.62	0.72	1.00
Input power P [W]	239	476	1230	159	321	646	147	226	438	136	180	271	115	132	158
Speed n [min ⁻¹]	736	698	478	713	646	291	696	646	234	658	604	183	578	510	147
Air flow V [m ³ /h]	0	2145	4720	0	1652	2800	0	1083	2259	0	802	1737	0	558	1343
Static pressure Δp_s [Pa]	298	256	0	275	216	0	259	208	0	233	180	0	181	129	0
Total pressure Δp_t [Pa]	298	257	6	275	217	2	259	208	1	233	180	1	181	129	0

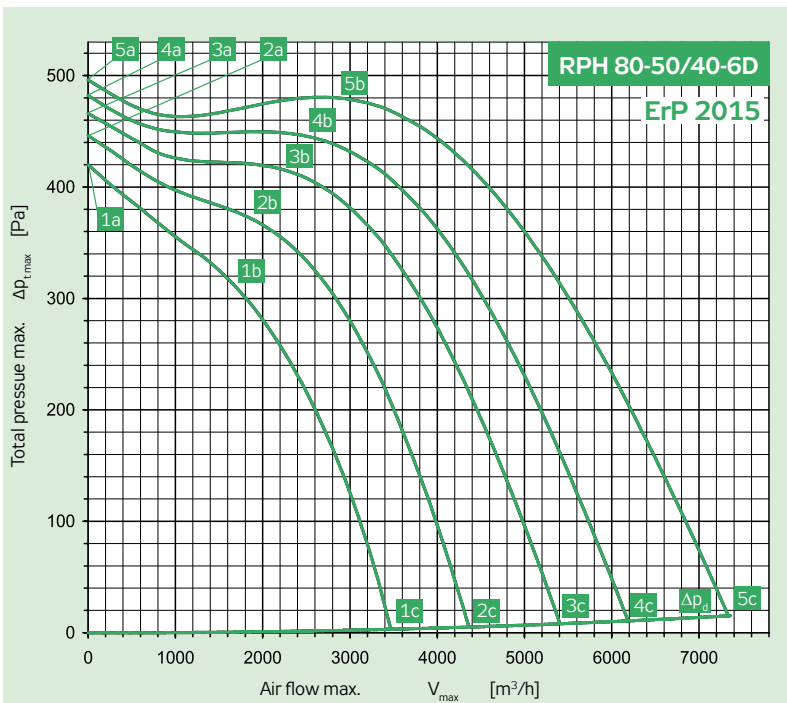

Power supply	Y	3× 400 V	50 Hz
Max. electric input	P_{max}	[W]	2824
Max. current (5c)	I_{max}	[A]	5.11
Mean speed	n	[min ⁻¹]	960
Capacitor	C	[F]	-
Max. working temp.	t_{max}	[°C]	50
Air flow max.	V_{max}	[m ³ /h]	7357
Total pressure max.	$\Delta p_{t,max}$	[Pa]	496
Static pressure min. (5c)	$\Delta p_{s,min}$	[Pa]	0
Weight	m	[kg]	132
Five-stage controller	type		TRN 7D
Protecting relay	type		STD

	Sání	Výtlak	Okolí
Bod	5b	5b	5b
Total sound power level LWA [dB(A)]			
L_{WA}	77	81	48
Sound power level LWAokt [dB(A)]			
125 Hz	70	68	48
250 Hz	66	68	37
500 Hz	69	75	24
1000 Hz	71	75	13
2000 Hz	70	74	8
4000 Hz	67	72	0
8000 Hz	58	61	0

Parameters in selected working points	5a	5b	5c	4a	4b	4c	3a	3b	3c	2a	2b	2c	1a	1b	1c
Voltage U [V]		230			180			160			130			105	
Current I [A]	2.17	2.58	5.11	1.43	2.08	4.99	1.22	2.03	4.90	1.11	2.00	4.40	1.08	2.10	3.80
Input power P [W]	441	1013	2824	276	724	1957	264	633	1556	229	512	1044	201	421	678
Speed n [min ⁻¹]	992	960	835	980	928	710	967	899	621	948	853	507	917	774	409
Air flow V [m ³ /h]	0	2918	7357	0	2518	6207	0	2255	5393	0	1943	4364	0	1767	3462
Static pressure Δp_s [Pa]	496	479	0	482	447	0	466	415	0	446	368	0	420	304	0
Total pressure Δp_t [Pa]	496	481	15	482	449	11	466	416	8	446	369	5	420	305	3

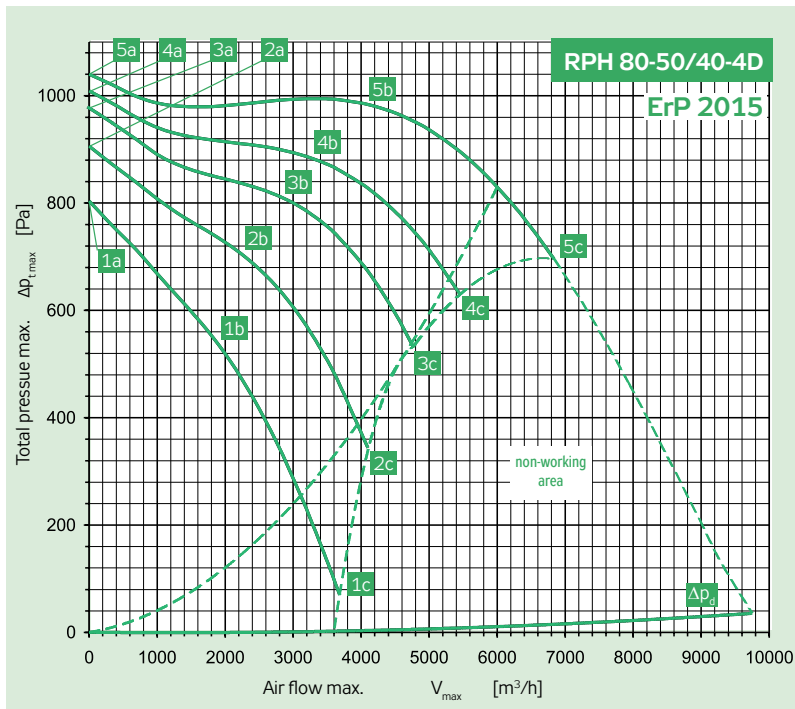

Power supply	Y	3 × 400 V	50 Hz
Max. electric input	P _{max}	[W]	4919
Max. current (5c)	I _{max}	[A]	8.10
Mean speed	n	[min ⁻¹]	1410
Capacitor	C	[F]	-
Max. working temp.	t _{max}	[°C]	40
Air flow max.	V _{max}	[m ³ /h]	6831
Total pressure max.	Δ p _{t max}	[Pa]	1040
Static pressure min. (5c)	Δ p _{s min}	[Pa]	683
Weight	m	[kg]	139
Five-stage controller	type		TRN 9D
Protecting relay	type		STD

	Sání	Výtlak	Okolí
Bod	5b	5b	5b
Total sound power level LWA [dB(A)]			
L _{WA}	88	92	57
Sound power level LWAokt [dB(A)]			
125 Hz	81	76	57
250 Hz	74	78	46
500 Hz	74	83	34
1000 Hz	83	88	25
2000 Hz	82	86	14
4000 Hz	78	84	0
8000 Hz	70	73	0

Parameters in selected working points	5a	5b	5c	4a	4b	4c	3a	3b	3c	2a	2b	2c	1a	1b	1c
Voltage U [V]	400						230			180			140		
Current I [A]	3.00	5.01	8.10	2.38	4.91	8.10	2.33	4.93	8.10	2.54	4.88	8.10	2.96	5.21	8.10
Input power P [W]	1217	2915	4919	903	2143	3498	782	1770	2800	721	1379	2117	671	1110	1516
Speed n [min ⁻¹]	1480	1414	1322	1452	1348	1195	1427	1293	1088	1380	1214	890	1298	1055	548
Air flow V [m ³ /h]	0	4135	6831	0	3307	5456	0	2894	4763	0	2306	4109	0	1957	3673
Static pressure Δp _s [Pa]	1040	982	683	1009	885	621	977	808	525	906	692	339	804	520	67
Total pressure Δp _t [Pa]	1040	987	696	1009	888	630	977	810	532	906	693	344	804	521	70

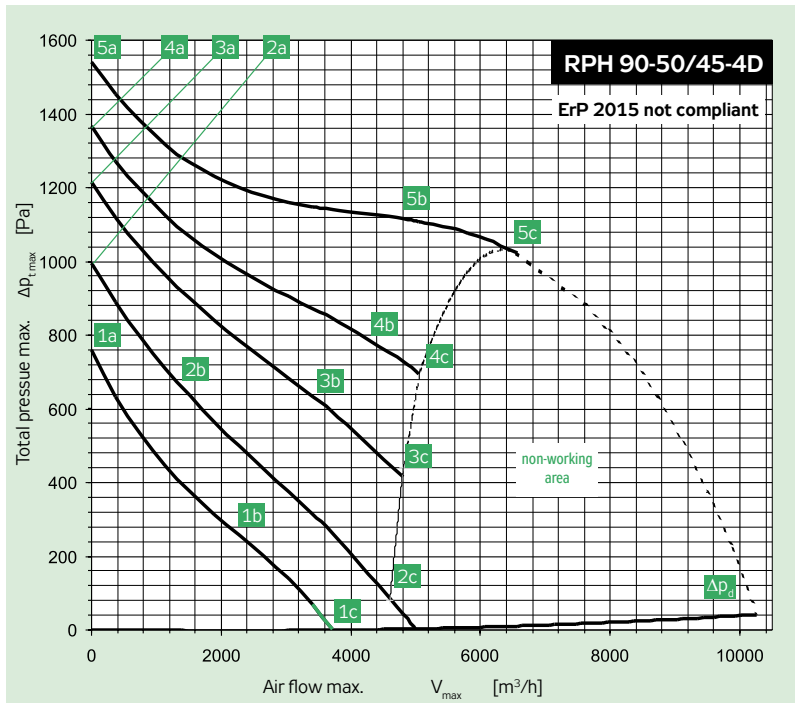

Power supply	Y	3 × 400 V	50 Hz
Max. electric input	P _{max}	[W]	4919
Max. current (5c)	I _{max}	[A]	8.30
Mean speed	n	[min ⁻¹]	1260
Capacitor	C	[F]	-
Max. working temp.	t _{max}	[°C]	55
Air flow max.	V _{max}	[m ³ /h]	6558
Total pressure max.	Δ p _{t max}	[Pa]	1541
Static pressure min. (5c)	Δ p _{s min}	[Pa]	1014
Weight	m	[kg]	168
Five-stage controller	type		TRN 9D
Protecting relay	type		STD

	Sání	Výtlak	Okolí
Bod	5b	5b	5b
Total sound power level LWA [dB(A)]			
L _{WA}	88	95	58
Sound power level LWAokt [dB(A)]			
125 Hz	74	75	58
250 Hz	73	80	48
500 Hz	78	88	38
1000 Hz	83	91	27
2000 Hz	83	90	16
4000 Hz	79	85	0
8000 Hz	71	76	0

Parameters in selected working points	5a	5b	5c	4a	4b	4c	3a	3b	3c	2a	2b	2c	1a	1b	1c
Voltage U [V]	400						230			180			140		
Current I [A]	3.74	7.20	8.30	3.44	7.41	8.30	3.65	6.97	8.30	4.07	5.07	8.17	4.11	5.50	6.32
Input power P [W]	1993	4269	4919	1402	3055	3367	1259	2318	2718	1073	1330	1927	829	1041	1119
Speed n [min ⁻¹]	1396	1259	1211	1343	1069	997	1280	957	800	1137	1009	376	978	623	285
Air flow V [m ³ /h]	0	5512	6558	0	4398	5055	0	3583	4805	0	1543	4986	0	2286	3707
Static pressure Δp _s [Pa]	1541	1111	1014	1367	777	693	1216	617	435	994	652	0	758	267	0
Total pressure Δp _t [Pa]	1541	1118	1023	1367	781	699	1216	619	440	994	652	5	758	268	3

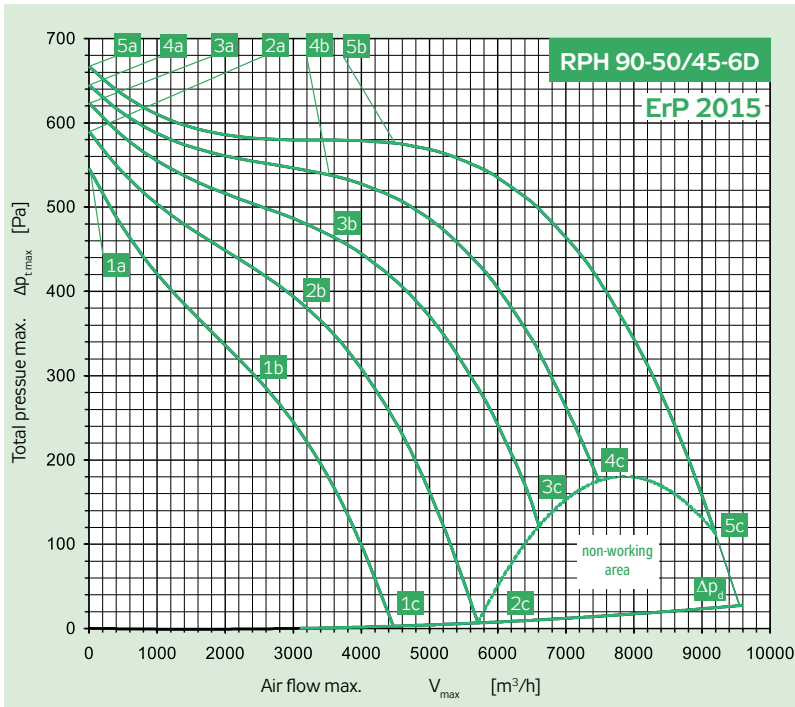

Power supply	Y	3 × 400 V	50 Hz
Max. electric input	P_{max}	[W]	3780
Max. current (5c)	I_{max}	[A]	6.80
Mean speed	n	[min ⁻¹]	930
Capacitor	C	[F]	-
Max. working temp.	t_{max}	[°C]	55
Air flow max.	V_{max}	[m ³ /h]	9200
Total pressure max.	$\Delta p_{t,max}$	[Pa]	667
Static pressure min. (5c)	$\Delta p_{s,min}$	[Pa]	90
Weight	m	[kg]	168
Five-stage controller	type		TRN 7D
Protecting relay	type		STD

	Sání	Výtlak	Okolí
Bod	5b	5b	5b
Total sound power level LWA [dB(A)]			
L_{WA}	81	88	48
Sound power level LWAokt [dB(A)]			
125 Hz	65	66	47
250 Hz	65	72	39
500 Hz	74	83	28
1000 Hz	75	82	15
2000 Hz	76	82	4
4000 Hz	72	78	0
8000 Hz	64	68	0

Parameters in selected working points	5a	5b	5c	4a	4b	4c	3a	3b	3c	2a	2b	2c	1a	1b	1c
Voltage U [V]	400			280			230			180			140		
Current I [A]	2.96	3.87	6.80	2.15	3.45	6.80	1.99	3.75	6.80	1.98	3.86	6.66	2.03	3.74	5.59
Input power P [W]	665	1757	3780	564	1315	2785	518	1242	2271	476	1025	1640	415	760	1040
Speed n [min ⁻¹]	968	926	832	948	879	713	931	825	621	899	749	443	846	659	351
Air flow V [m ³ /h]	0	4463	9200	0	3575	7483	0	3503	6609	0	3154	5712	0	2550	4462
Static pressure Δp_s [Pa]	667	574	90	645	541	163	624	467	111	590	381	0	546	295	0
Total pressure Δp_t [Pa]	667	578	112	645	544	175	624	470	121	590	383	7	546	296	4

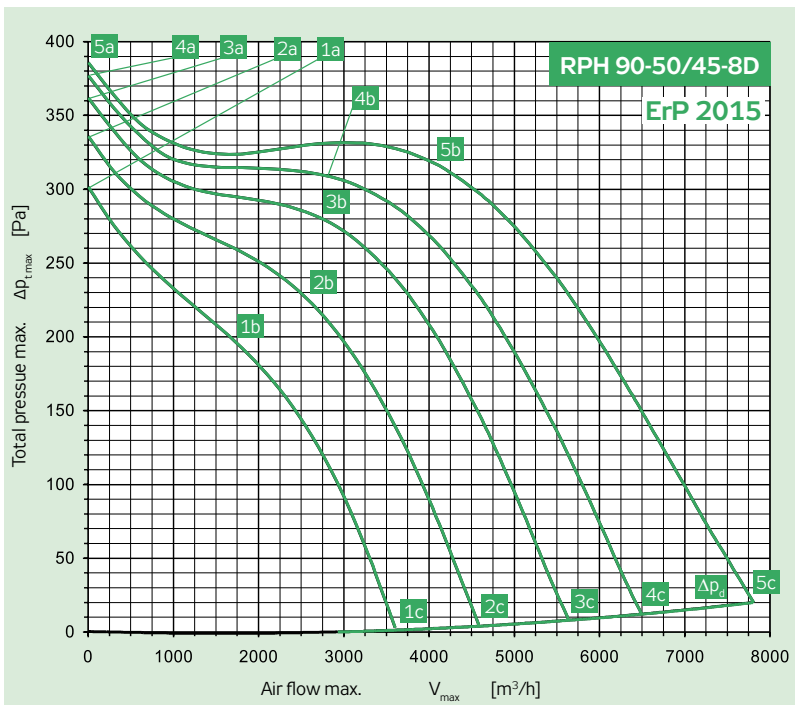

Power supply	Y	3 × 400 V	50 Hz
Max. electric input	P_{max}	[W]	1892
Max. current (5c)	I_{max}	[A]	3.88
Mean speed	n	[min ⁻¹]	690
Capacitor	C	[F]	-
Max. working temp.	t_{max}	[°C]	55
Air flow max.	V_{max}	[m ³ /h]	7810
Total pressure max.	$\Delta p_{t,max}$	[Pa]	386
Static pressure min. (5c)	$\Delta p_{s,min}$	[Pa]	0
Weight	m	[kg]	165
Five-stage controller	type		TRN 4D
Protecting relay	type		STD

	Sání	Výtlak	Okolí
Bod	5b	5b	5b
Total sound power level LWA [dB(A)]			
L_{WA}	74	81	41
Sound power level LWAokt [dB(A)]			
125 Hz	59	58	40
250 Hz	61	69	34
500 Hz	68	77	23
1000 Hz	64	74	8
2000 Hz	69	75	0
4000 Hz	65	71	0
8000 Hz	55	61	0

Parameters in selected working points	5a	5b	5c	4a	4b	4c	3a	3b	3c	2a	2b	2c	1a	1b	1c
Voltage U [V]	400			280			230			180			140		
Current I [A]	2.20	2.49	3.88	1.54	2.03	3.78	1.32	1.87	3.61	1.14	1.92	3.20	1.08	1.67	2.73
Input power P [W]	350	813	1892	264	624	1398	222	518	1081	196	455	733	178	311	477
Speed n [min ⁻¹]	725	694	610	715	661	505	704	641	434	683	577	349	646	543	277
Air flow V [m ³ /h]	0	3522	7810	0	2951	6493	0	2529	5632	0	2474	4581	0	1675	3603
Static pressure Δp_s [Pa]	386	328	0	377	307	0	362	284	0	336	230	0	302	195	0
Total pressure Δp_t [Pa]	386	329	20	377	309	12	362	286	9	336	232	5	302	195	3

RP
RQ
RO
RE
RF
RPH
EX
TR.
EO..
VO
SUMX
CHV
CHF
HRV
HRZ
PRI

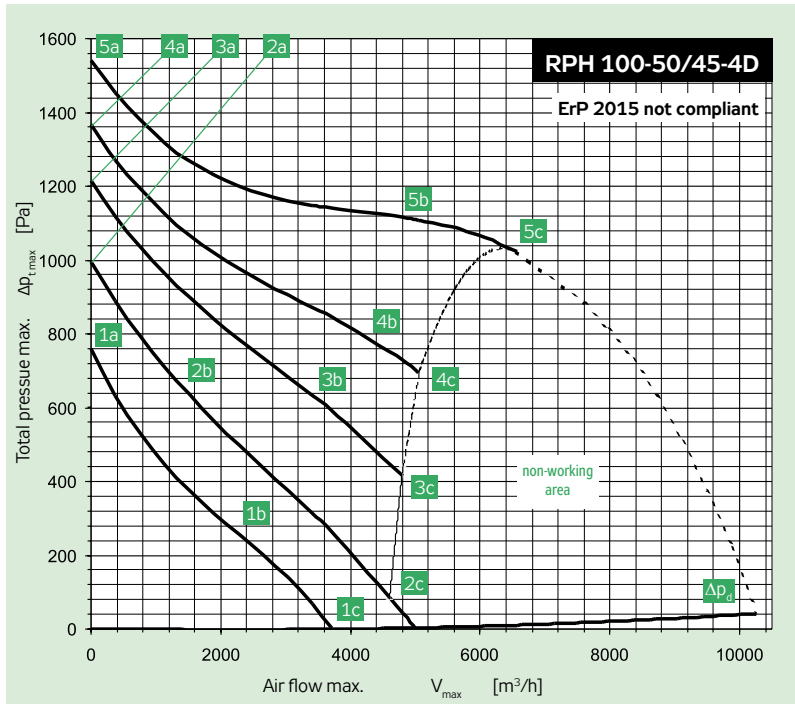

Power supply	Y	3 × 400 V	50 Hz
Max. electric input	P_{max}	[W]	4919
Max. current (5c)	I_{max}	[A]	8.30
Mean speed	n	[min ⁻¹]	1260
Capacitor	C	[F]	-
Max. working temp.	t_{max}	[°C]	55
Air flow max.	V_{max}	[m ³ /h]	6558
Total pressure max.	$\Delta p_{t max}$	[Pa]	1541
Static pressure min. (5c)	$\Delta p_{s min}$	[Pa]	1014
Weight	m	[kg]	177
Five-stage controller	type		TRN 9D
Protecting relay	type		STD

	Sání	Výtlak	Okolí
Bod	5b	5b	5b
Total sound power level LWA [dB(A)]			
L_{WA}	88	95	58
Sound power level LWAokt [dB(A)]			
125 Hz	74	75	58
250 Hz	73	80	48
500 Hz	78	88	38
1000 Hz	83	91	27
2000 Hz	83	90	16
4000 Hz	79	85	0
8000 Hz	71	76	0

Parameters in selected working points	5a	5b	5c	4a	4b	4c	3a	3b	3c	2a	2b	2c	1a	1b	1c
Voltage U [V]	400			280			230			180			140		
Current I [A]	3.74	7.20	8.30	3.44	7.41	8.30	3.65	6.97	8.30	4.07	5.07	8.17	4.11	5.50	6.32
Input power P [W]	1993	4269	4919	1402	3055	3367	1259	2318	2718	1073	1330	1927	829	1041	1119
Speed n [min ⁻¹]	1396	1259	1211	1343	1069	997	1280	957	800	1137	1009	376	978	623	285
Air flow V [m ³ /h]	0	5512	6558	0	4398	5055	0	3583	4805	0	1543	4986	0	2286	3707
Static pressure Δp_s [Pa]	1541	1089	1014	1367	787	693	1216	617	435	994	652	0	758	257	0
Total pressure Δp_t [Pa]	1541	1096	1023	1367	791	699	1216	619	440	994	652	5	758	258	3

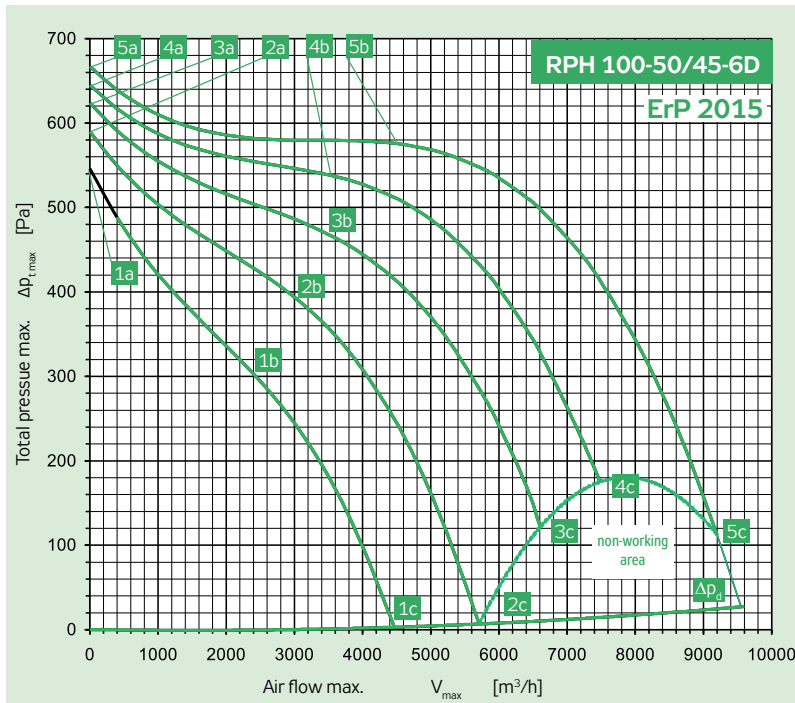

Power supply	Y	3 × 400 V	50 Hz
Max. electric input	P_{max}	[W]	3780
Max. current (5c)	I_{max}	[A]	6.80
Mean speed	n	[min ⁻¹]	930
Capacitor	C	[F]	-
Max. working temp.	t_{max}	[°C]	55
Air flow max.	V_{max}	[m ³ /h]	9200
Total pressure max.	$\Delta p_{t max}$	[Pa]	667
Static pressure min. (5c)	$\Delta p_{s min}$	[Pa]	90
Weight	m	[kg]	177
Five-stage controller	type		TRN 7D
Protecting relay	type		STD

	Sání	Výtlak	Okolí
Bod	5b	5b	5b
Total sound power level LWA [dB(A)]			
L_{WA}	81	88	48
Sound power level LWAokt [dB(A)]			
125 Hz	65	66	47
250 Hz	65	72	39
500 Hz	74	83	28
1000 Hz	75	82	15
2000 Hz	76	82	4
4000 Hz	72	78	0
8000 Hz	64	68	0

Parameters in selected working points	5a	5b	5c	4a	4b	4c	3a	3b	3c	2a	2b	2c	1a	1b	1c
Voltage U [V]	400			280			230			180			140		
Current I [A]	2.96	3.87	6.80	2.15	3.45	6.80	1.99	3.75	6.80	1.98	3.86	6.66	2.03	3.74	5.59
Input power P [W]	665	1757	3780	564	1315	2785	518	1242	2271	476	1025	1640	415	760	1040
Speed n [min ⁻¹]	968	926	832	948	879	713	931	825	621	899	749	443	846	659	351
Air flow V [m ³ /h]	0	4463	9200	0	3575	7483	0	3503	6609	0	3154	5712	0	2550	4462
Static pressure Δp_s [Pa]	667	574	90	645	541	163	624	467	111	590	381	0	546	295	0
Total pressure Δp_t [Pa]	667	578	112	645	544	175	624	470	121	590	383	7	546	296	4

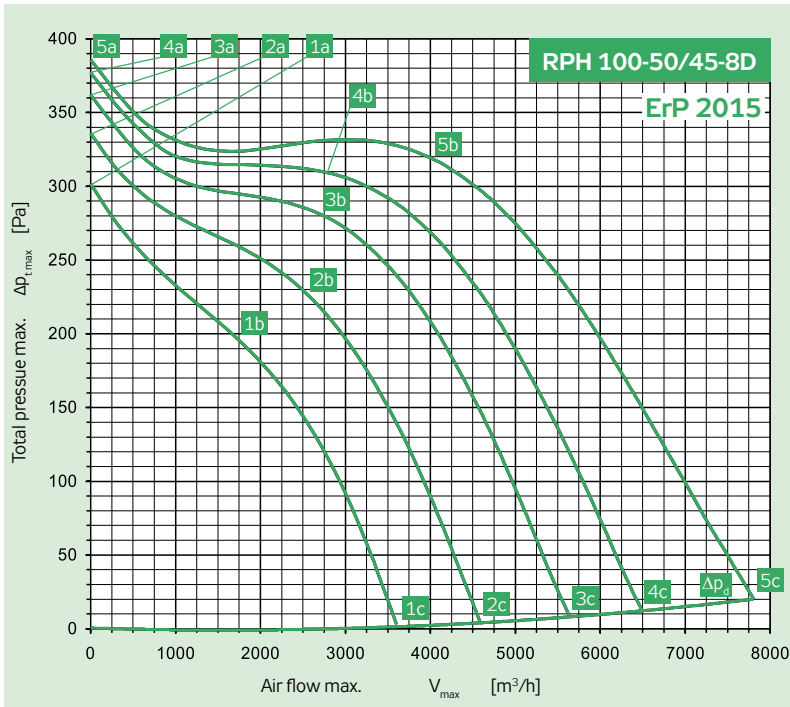

Power supply	Y	3× 400 V	50 Hz
Max. electric input	P_{max}	[W]	1892
Max. current (5c)	I_{max}	[A]	3.88
Mean speed	n	[min ⁻¹]	690
Capacitor	C	[F]	-
Max. working temp.	t_{max}	[°C]	55
Air flow max.	V_{max}	[m ³ /h]	7810
Total pressure max.	$\Delta p_{t,max}$	[Pa]	386
Static pressure min. (5c)	$\Delta p_{s,min}$	[Pa]	0
Weight	m	[kg]	174
Five-stage controller	type		TRN 4D
Protecting relay	type		STD

	Sání	Výtlak	Okolí
Bod	5b	5b	5b
Total sound power level LWA [dB(A)]			
L_{WA}	74	81	41
Sound power level LWAokt [dB(A)]			
125 Hz	59	58	40
250 Hz	61	69	34
500 Hz	68	77	23
1000 Hz	64	74	8
2000 Hz	69	75	0
4000 Hz	65	71	0
8000 Hz	55	61	0

Parameters in selected working points	5a	5b	5c	4a	4b	4c	3a	3b	3c	2a	2b	2c	1a	1b	1c
Voltage U [V]	400			280			230			180			140		
Current I [A]	2.20	2.49	3.88	1.54	2.03	3.78	1.32	1.87	3.61	1.14	1.92	3.20	1.08	1.67	2.73
Input power P [W]	350	813	1892	264	624	1398	222	518	1081	196	455	733	178	311	477
Speed n [min ⁻¹]	725	694	610	715	661	505	704	641	434	683	577	349	646	543	277
Air flow V [m ³ /h]	0	3522	7810	0	2951	6493	0	2529	5632	0	2474	4581	0	1675	3603
Static pressure Δp_s [Pa]	386	328	0	377	307	0	362	284	0	336	230	0	302	195	0
Total pressure Δp_t [Pa]	386	329	20	377	309	12	362	286	9	336	232	5	302	195	3

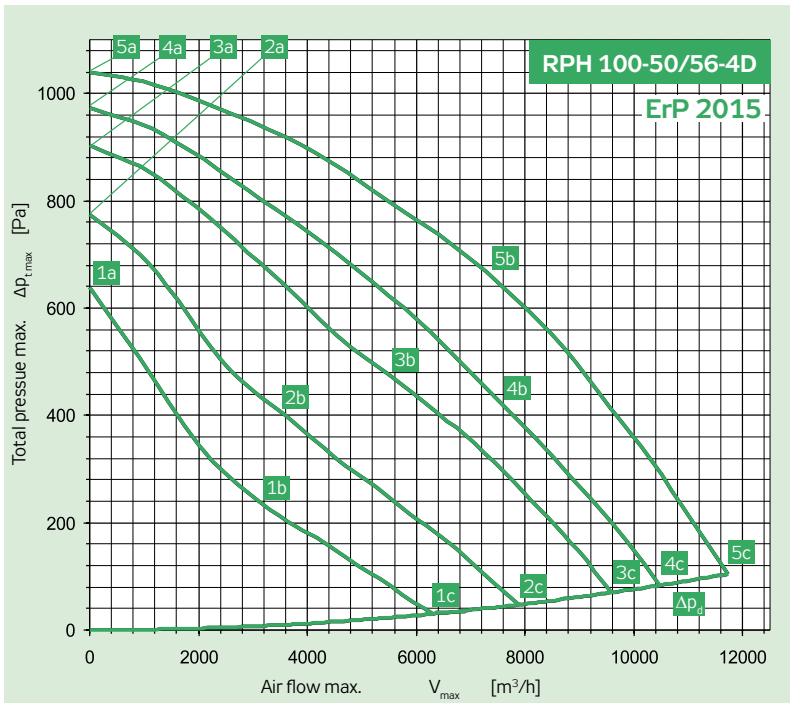

Power supply	Y	3× 400 V	50 Hz
Max. electric input	P_{max}	[W]	3205
Max. current (5c)	I_{max}	[A]	5.50
Mean speed	n	[min ⁻¹]	1383
Capacitor	C	[F]	-
Max. working temp.	t_{max}	[°C]	50
Air flow max.	V_{max}	[m ³ /h]	11731
Total pressure max.	$\Delta p_{t,max}$	[Pa]	1039
Static pressure min. (5c)	$\Delta p_{s,min}$	[Pa]	0
Weight	m	[kg]	206
Five-stage controller	type		TRN 7D
Protecting relay	type		STD

	Sání	Výtlak	Okolí
Bod	5b	5b	5b
Total sound power level LWA [dB(A)]			
L_{WA}	92	98	55
Sound power level LWAokt [dB(A)]			
125 Hz	73	78	53
250 Hz	80	90	51
500 Hz	88	93	40
1000 Hz	87	94	27
2000 Hz	85	90	19
4000 Hz	77	82	0
8000 Hz	68	71	0

Parameters in selected working points	5a	5b	5c	4a	4b	4c	3a	3b	3c	2a	2b	2c	1a	1b	1c
Voltage U [V]	400			280			230			180			140		
Current I [A]	3,20	5,20	5,40	3,30	5,90	6,00	3,60	6,10	6,20	4,00	5,80	6,20	4,20	5,40	5,70
Input power P [W]	1546	3041	3142	1369	2512	2584	1261	2173	2198	1101	1539	1625	865	1064	1126
Speed n [min ⁻¹]	1434	1358	1356	1372	1215	1208	1308	1109	1105	1177	944	901	1015	758	720
Air flow V [m ³ /h]	0	6685	11731	0	6855	10471	0	5474	9578	0	3612	7875	0	2942	6312
Static pressure Δp_s [Pa]	1039	681	0	973	460	0	903	456	0	775	388	0	638	247	0
Total pressure Δp_t [Pa]	1039	715	104	973	495	83	903	478	70	775	398	47	638	254	30

INSTALLATION

- RPH fans (including other Vento elements and equipment) are not intended, due to their concept, for direct sale to end customers. Each installation must be performed in accordance with a professional project created by a qualified air-handling designer who is responsible for the proper selection of fan. The installation and commissioning may be performed only by an authorized company licensed in accordance with generally valid regulations.
 - It is recommended to insert the DV elastic connections in front of and behind the fan.
 - It is advisable to always place the KFD or VFK air filters, respectively VFT metal grease filter in front of the fan to protect the fan and duct against dirtying and dust fouling.
 - The fan must always be mounted on a separate hinges to avoid dampers or connected piping to be burdened. Trailers must be noise-isolated noise and vibration-proof (elastic shock absorber).
 - RPH fans can work only in a horizontal position. When placed under the ceiling is useful (for better access to the terminal block and the motor) to mount fan motor facing cup downwards.
 - In cramped areas, it is advisable to consider the necessity to situate directly behind the fan's outlet the duct adapting piece, attenuator, heat exchanger, heater, etc.
 - The construction and arrangement of the fan outlet is similar to the RP fan. It is obvious that from the entire cross-section (e.g. 500 x 250) only 1/4 of the outlet cross-section is free. This means that the airflow velocities close behind the fan can be as much as four times higher than, for example, in the inlet. Therefore, the greater the distance of attenuators (or other resistant elements) from the outlet, the better ¹⁾.
- On the inlet side, the DV elastic connection will be sufficient as a distance piece in most cases.

WIRING

- The wiring can be performed only by a qualified worker licensed in accordance with national regulations.
- Terminal box located under opening panel with handle is fixed with screws to the fan casing is equipped with WAGO terminals; max. cross-section of connecting conductors 1.5 mm²
- The fans are equipped with thermo-contacts situated in the motor winding; they are connected to the TK terminals. If the motor is overloaded, the thermo-contact will open. To evaluate the failure, the thermo-contact must be connected to the control or regulating system (e.g. control unit, TRN controller or STE(D) relay) which is able to evaluate the failure, and protect the motor against unwanted thermal effects.
- For fan wiring diagram refer to figure 5.

FIGURE 5 – WIRING DIAGRAM

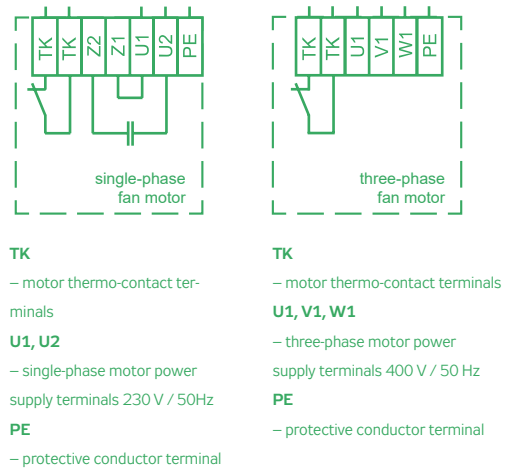

On the following pages you will find some basic examples of the fan connection to output controllers and control units. AeroCAD software is available for precise design of the wiring.

¹⁾ That recommendation applies to all duct fans.

EXAMPLE A
RPH FAN WITHOUT OUTPUT CONTROL
AND WITH STE(D) PROTECTING RELAY

The RPH fan connection in a simple venting system without output control is shown in figure # 6.

This connection ensures:

- Full thermal protection of the fan using thermo-contacts and protecting relay, STE (single-phase) or STD (three-phase).
- Manual switching of the fan on/off using buttons on the STE(D) protecting relay.

After pressing the button marked "I" on the STE(D) protecting relay, the fan starts and the button will stay in the depressed position, signalling the fan's operation. The fan can be stopped by pressing the button marked "O".

If the motor winding is overheated above 130 °C due to overloading, the thermo-contacts in the motor winding will open. Upon the thermo-contacts opening, which are interconnected with the fan terminal box, the STE(D) protecting relay circuit TK, TK will be disconnected. As a reaction to this state, the STE(D) protecting relay will disconnect the power supply to the overheated motor. After cooling down, the motor is not automatically restarted. The failure must be confirmed (unblocked) by the operator by pressing the black "I" button.

FIGURE 6 – FAN CONNECTION

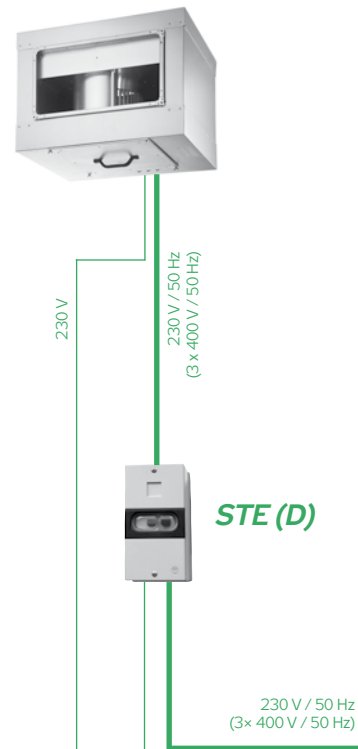

EXAMPLE B
RPH FAN WITH OUTPUT CONTROL
AND TRN CONTROLLER

The RPH fan connection in a venting system with output control using TRN controller with ORe5 controller is shown in figure # 7.

This connection ensures:

- The possibility of fan output selection within the stage range 1–5 as well as full protection via thermo-contacts.
- Fan switching on/off manually, by the ORe5 remote controller or any other switch (like room thermostat, gas detector, pressostat, hygostat, etc).

Upon selecting the required output stage using a selector on the ORe 5 controller the fan will start at corresponding speed. The closed switch connected to PT1, PT2 terminals and the thermo-contact circuit connected to TK,TK terminals are essential for the fan operation. The switch connected to PT1, PT2 terminals can externally stop the fan. If this option is not used, it will be necessary to interconnect terminals PT1 and PT2.

If the fan is overloaded, the thermo-contact circuit will be disconnected due to overheating of the motor winding. As a reaction to this state, the controller will disconnect the fan power supply, and the red control light on the ORe controller will signal the failure. After cooling down, the motor is not automatically restarted. To restart the fan, it is necessary first to set the selector to the "STOP" position, and thus confirm failure removal, and then to set the required fan output. In this arrangement, the option "STOP" on Ore 5 must not be blocked.

FIGURE 7 – FAN CONNECTION

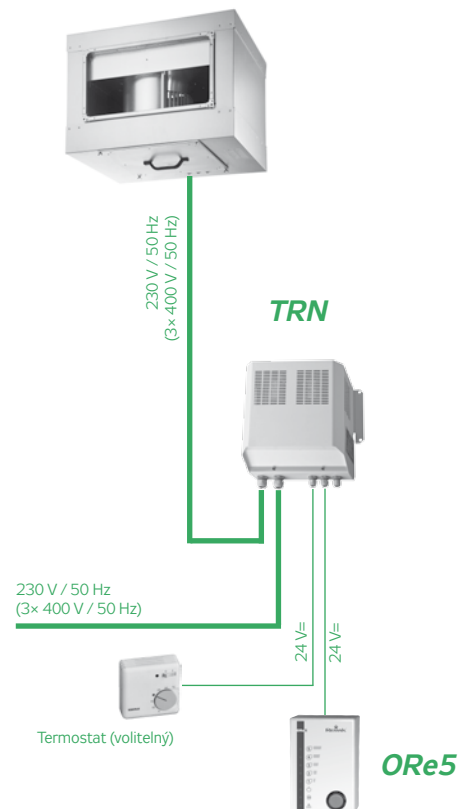

EXAMPLE C
RPH FAN WITH TRN CONTROLLER
AND CONTROL UNIT

The RPH fan with TRN output controller and a common internal controller in more sophisticated venting systems using the control unit is shown in figure # 8. The internal control is installed in the control unit during production.

This connection ensures:

- Fan switching on/off by the control unit. The motor protection must always be ensured by the control unit while TK,TK thermo-contact terminals are connected to 5a, 5a, 5b, 5b terminals in the control unit.
- Fan output control within the stage range 1-5 manually via HMI controller or using time schedule function of the control unit.

In the connection with control unit, all additional functions of the controller must always be blocked by interconnecting the PT2 and E48 terminals in the TRN-D controller..

The air-handling system is started by the control unit. All protecting and safety functions of fans as well as the entire system are ensured by the control unit.

FIGURE 8 – FAN CONNECTION

