

FAN USE

Fully controlled, low-pressure RQ Radial Fans intended for square ducts can be universally used for complex air-conditioning, from simple venting installations to sophisticated air-handling systems. Ideally, they can be used along with other components of the Ven-to modular system, which ensures inter-compatibility and balanced parameters.

OPERATING CONDITIONS, POSITION

These fans are designed for indoor and outdoor applications, and to transport air without solid, fibrous, sticky, aggressive, respectively explosive impurities. The transported air must be free of corrosive chemicals and chemicals aggressive to zinc and/or aluminium. The acceptable temperature of transported air can range from -30 °C to +40 °C, and with certain types up to +70 °C. The maximum nominal values for each fan are included in table # 3. RQ fans can work in any position.

DIMENSIONAL RANGE

RQ fans are manufactured in a range of seven sizes according to the A x B dimensions of the connecting outlet flange. Several fans differing mainly in the number of poles the motor uses are available for each size. When planning the fan for the required air flow and pressure, the following general rule is applied; fan motors with a higher number of poles reach the required parameters at lower RPM, which results in lower noise and longer service life. Fans with a higher number of poles also have lower air velocity in the cross section, which results in lower pressure losses in the duct and accessories, however, at higher investment costs. The standard dimensional and performance range of single-phase and three-phase RQ fans enables designers to optimize all parameters for air flow up to 7.800 m³ per hour.

MATERIALS

The external casing of RQ fans is made of galvanized steel sheets (Zn 275 g/m²). Impeller blades – with forward curved blades are made of galvanized sheet steel, with aluminium diffusers. Motors are made of aluminium alloys, copper and plastics. The motor's high quality enclosed ball bearings with permanent lubricating filling enable the fans to reach a service life above 40,000 operating hours without maintenance.

MOTORS

Compact single-phase and three-phase asynchronous motors with an external rotor and a resistance armature are used as drives. The motors are situated inside the impeller, and during operation are optimally cooled by the flowing air. The motors feature low build-up current. Impellers along with the motor are perfectly statically and dynamically balanced. The motor electric protection degree is IP 54 for all RQ fans except of RQ 20 and RQ 25 fans (IP 44).

ELECTRICAL EQUIPMENT

The wiring is terminated in a terminal box of IP 54 protection degree. Single-phase motors are equipped with a starting capacitor which is mounted on the fan casing. For wiring diagrams, refer to a separate section.

MOTOR PROTECTION

As standard, permanent monitoring of the internal motor temperature is used in all motors. The limit temperature is monitored by thermal contacts (TK-thermo-contacts) situated in the motor winding. The thermo-contacts are miniature thermal tripping elements which after being connected to the protective contactor circuit protect the motor against overheating (damaging) due to phase failure, forced motor braking, current protection circuit breakdown or excessive temperature of the transported air. Thermal protection by means of thermo-contacts is comprehensive and reliable providing they are correctly connected. This type of protection is essential especially for speed controlled and frequently started motors and motors highly thermally loaded by hot transported air. **Therefore, the fan motors cannot be protected by conventional thermal protection ensured by the motor overcurrent protective elements!**

Maximum permanent thermo-contact loading is 1.2 A at 250V / 50V (cos φ 0.6), (respectively 2 A at cos φ 1.0).

FAN OUTPUT CONTROL

Generally, several types of control can be used with fans. However, voltage control is the most suitable for RQ fans. RQ fans can be steplessly controlled providing the change in voltage is stepless.¹⁾ In practice, stage voltage controllers are most often used. TRN stage voltage controllers can control the fan output in five stages in 20 % steps, with which five pressure-airflow relation curves in the working characteristic of each fan comport. Refer to table # 1 2) showing the correlation between the input voltage and selected stage of the controller for single-phase and three-phase motors. RQ fan motors can be operated within a range of approx. from 25 % to 110 % of the rated voltage. The recommended product line includes single-phase and three-phase TRN controllers (simplified TRRE and TRRD controllers can also be used to control RQ fans; however, they do not provide a protection function.

TABLE 1 – THE INPUT VOLTAGE AND CONTROLLER'S STAGE

MOTOR TYPE	CURVE CHARACTERISTICS – CONTROLLER'S STAGE				
	5	4	3	2	1
1 – phase	230 V	180 V	160 V	130 V	105 V
3 – phase	400 V	280 V	230 V	180 V	140 V

¹⁾ Refer to chapter „Stepless Electronic Control“ of RP fans .

²⁾ For detailed information, refer to the chapter "Fan Output controllers".

MEASURING THE PARAMETERS

The output characteristics of RQ fans are measured in REMAK testing laboratory for aerodynamic and electrical measurements of fans and pressure losses of passive elements. This testing laboratory is equipped with a LabView® computer system from National Instruments® for the automatic collection and evaluation of all measured data. This testing laboratory complies with EN 24 163 and AMCA STANDARD 210-74 Standards. Noise parameters of RQ fans are measured in REMAK's acoustic testing laboratory in accordance with the ČSN EN ISO 3743-2 Standard, which establishes the technical method of the sound power level determination in a special reverberant chamber.

A measuring line of aerodynamic parameters is used to set the fan to the required working point when measuring the noise.

Operating Characteristics

Output characteristics in the "Data Section" determine the relationship curve of the air flow rate V (m³/h) and total fan pressure $\Delta p_t = \Delta p_s + p_d$ (Pa). For an explanation of the correlations and relations of important data, refer to the section "RP Fans".

Noise Parameters

In the "Data Section" of this catalogue you will find noise parameters radiated to the outlet, surroundings and inlet. The total sound power level L_{WA} [dB (A)], i.e. the total level of the radiated A-scale sound power, is always given. Further, the octave value L_{WAokt} of the A-scale sound power level for octave bands from 125 Hz to 8 kHz is also given.³⁾

ACCESSORIES

RQ fans belong in the wide range of Vento modular venting and air-handling system components. Any air-handling set-up, from simple venting to sophisticated comfortable air-conditioning, can be created by selecting suitable elements. The following accessories can be ordered along with RQ fans:

- Elastic connections DV, DK, counter-flanges
- TRN Controllers and ORe 5 controllers
- TRRE, TRRD Controllers
- STE, STD Protecting Relays

TABLE 2 - FAN DIMENSIONS

Type	Dimensions in mm																
	A	B	C	D	E	F	G	H	I	J	K	L	M	P	Q	DK ¹⁾	DV ²⁾
RQ 20..	335	405	125	250	145	270	150	250	225	235	203	172	8	236	193	200	200 x 125
RQ 22..	370	445	140	280	160	300	170	300	245	260	221	190	8	263	215	225	280 X 140
RQ 25..	410	495	160	315	180	335	190	300	270	285	243	212	8	289	236	250	315 x 160
RQ 28..	460	545	180	355	200	375	210	350	295	315	263	232	8	322	263	280	355 X 180
RQ 31..	515	615	200	400	220	420	230	400	325	350	285	254	8	360	312	315	400 x 200
RQ 35..	580	690	225	450	245	470	250	400	340	390	303	272	8	403	330	355	450 X 225
RQ 40..	655	770	250	500	270	520	280	450	380	445	331	300	8	451	370	400	500 x 250

¹⁾ circular damping insert on the fan / ²⁾ square damping insert on the fan outlet

FAN DESCRIPTION AND DESIGNATION

The key for type designation of RP fans in projects and orders is defined in figure # 1). For example, type designation RQ 28-4D specifies the type of fan, impeller and motor.

FIGURE 1 – TYPE DESIGNATION OF RQ FANS

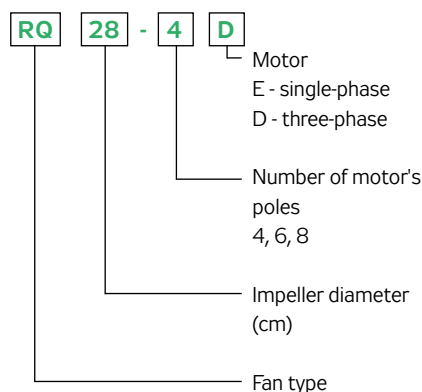

DIMENSIONS, WEIGHTS AND PERFORMANCE

For important dimensions of RQ fans, refer to Figure #2 and Table #3. For basic parameters refer to table #3. All further important data are included along with each fan's characteristics in the "Data Section".

FIGURE 2 – FAN DIMENSIONAL DIAGRAM

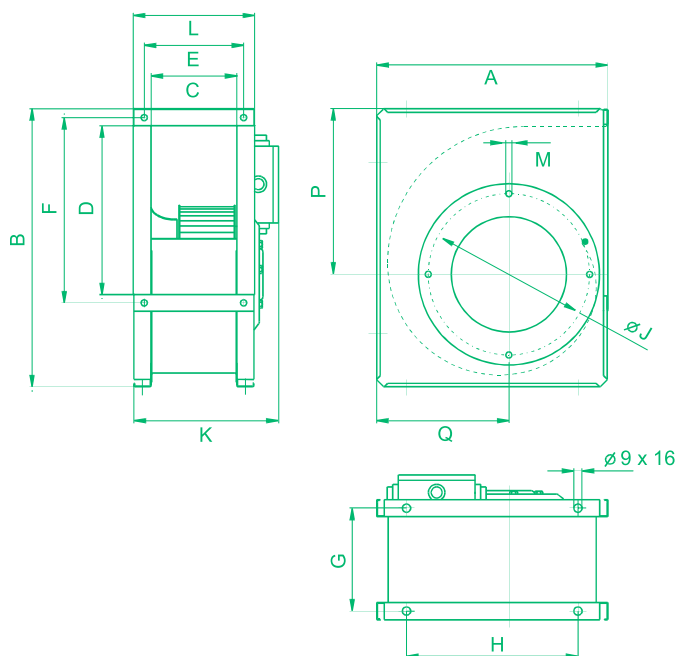

TABLE 3 – FAN BASIC PARAMETERS AND NOMINAL VALUES

Fan Type	V_{max}	$\Delta p_{t,max}$	n_{nom}	U_{nom}	I_{max}	t_{max}	C	Regul.	m	ErP2015	
	m ³ /h	Pa	min ⁻¹	V	A	°C	μF	typ	kg		
SINGLE-PHASE FANS											
RQ 20-4E	1135	303	1400	230	1.47	40	5	TRN 2E	9	✘	—
RQ 22-4E	1627	508	1380	230	2.3	40	8	TRN 4E	14	✘	—
RQ 25-4E	2350	861	1370	230	3.85	55	14	TRN 4E	17	✘	—
RQ 28-4E	2607	1079	1370	230	5.1	40	16	TRN 7E	23	✘	—
THREE-PHASE FANS											
RQ 20-4D	1240	290	1350	3x 400	0.49	70	-	TRN 2D	9	✓	η=32.2% (statA) N=44.0 (N44)
RQ 22-6D	1370	233	920	3x 400	0.46	55	-	TRN 2D	11	✓	does not apply (P1 < 125 W)
RQ 22-4D	1840	535	1410	3x 400	0.94	40	-	TRN 2D	14	✘	—
RQ 25-6D	1780	337	910	3x 400	0.7	55	-	TRN 2D	14	✘	—
RQ 25-4D	2701	1058	1430	3x 400	1.98	50	-	TRN 2D	15	✘	—
RQ 28-6D	2730	643	950	3x 400	1.37	55	-	TRN 2D	17	✘	—
RQ 28-4D	3130	1278	1420	3x 400	2.22	40	-	TRN 4D	23	✓	η=39.2% (statA) N=47.1 (N44)
RQ 31-6D	3798	946	920	3x 400	1.82	40	-	TRN 2D	23	✘	—
RQ 31-4D	4482	2494	1410	3x 400	4.1	40	-	TRN 7D	30	✓	η=38.8% (statA) N=45.9 (N44)
RQ 35-8D	3723	672	650	3x 400	1.4	55	-	TRN 2D	37	✘	—
RQ 35-6D	4022	1084	890	3x 400	2	40	-	TRN 2D	40	✓	η=36.6% (statA) N=44.0 (N44)
RQ 35-4D	5886	3534	1400	3x 400	6	40	-	TRN 7D	47	✓	η=41.2% (statA) N=46.3 (N44)
RQ 40-8D	4700	1274	670	3x 400	2.41	55	-	TRN 4D	48	✓	η=37.3% (statA) N=45.6 (N44)
RQ 40-6D	7800	2770	940	3x 400	5.1	50	-	TRN 7D	51	✓	η=42.2% (statA) N=48.2 (N44)
RQ 40-4D	6768	4873	1390	3x 400	8.1	40	-	TRN 9D	58	✓	η=44.4% (statA) N=47.9 (N44)

LEGENDA K SYMBOLŮM V TABULCE 3:

- V_{max} maximum air flow rate
- n fan speed measured at the highest efficiency working point (5b), rounded to tens
- U** nominal power supply voltage of the motor without control (all values in the table are to this voltage)
- P_{max} electric motor maximal power output
- I_{max} maximum phase current at voltage **U** (this value must be checked)
- t_{max} maximum permissible transported air temperature at air flow V_{max} .
- C** capacitor capacity with single-phase fans
- FM.** frequency inverter
- m** weight of the fan (±10%)
- ErP2015** Fan compliance with the requirements of Regulation 2009/125/EC (NOT compliant fans must not be used within EU region)

DATA SECTION

In the data section of the catalog, in addition to the characteristics of each fan, there is a table of the most important values. The importance of individual lines is explained in Table 4. These values are also listed on the nameplate of each fan. Graph 1 enables quick selection of a suitable fan and alternate comparison of RQ fans. Only the highest characteristics of each fan at nominal supply voltage, i.e. without a controller or with a controller set to five stage, are included in this graph.

EXAMPLE AND EXPLANATION OF FAN DATA

RQ 20-4E

Power supply	Y	230 V	50 Hz
Max. electric input	P_{max}	[W]	303
Max. current (5c)	I_{max}	[A]	1.47
Mean speed	n	[min ⁻¹]	1400
Capacitor	C	[F]	5
Max. working temp.	t_{max}	[°C]	40
Max. air-flow rate	V_{max}	[m ³ /h]	1135
Max. total pressure	$\Delta p_{t,max}$	[Pa]	225
Min. static pressure (5c)	$\Delta p_{s,min}$	[Pa]	0
Weight	m	[kg]	9
Five-stage controller	type		TRN 2E
Protecting relay	type		STE

The meaning of individual lines is as follows:

- 1 Value of nominal power supply voltage
- 2 Maximum power input of the motor at working point 5c.
- 3 Maximum current at nominal voltage at working point 5c.
- 4 Mean speed, rounded to tens, measured at working point 5b.
- 5 Capacitor capacity with single-phase fans.
- 6 Maximum permissible transported air temperature.
- 7 Maximum air flow at working point 5c.
- 8 Maximum total pressure between points 5a–5c
- 9 Minimum permissible static pressure at point 5c.
- 10 Total weight of the fan.
- 11 Recommended fan output controller.
- 12 Recommended protecting relay of the fan without controller and control unit.

GRAPH 1 – RQ FAN CHARACTERISTICS QUICK SELECTION

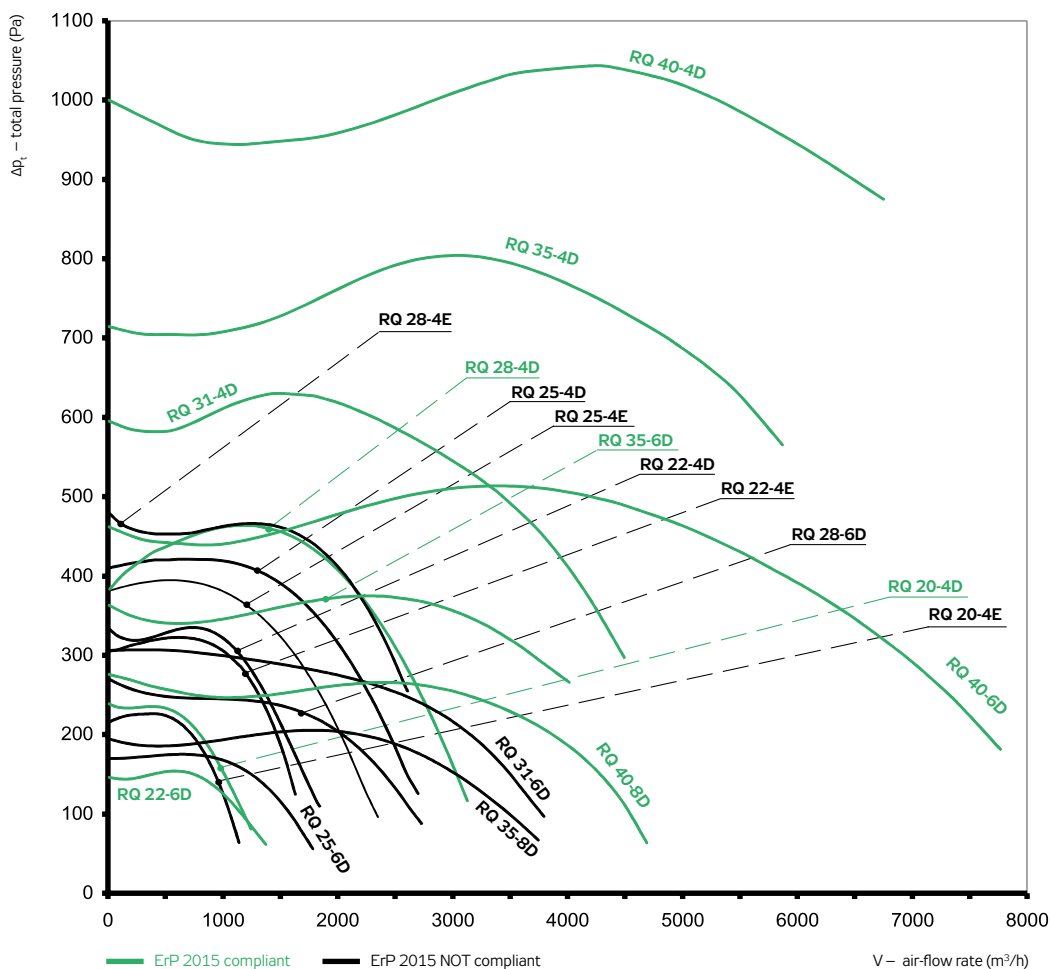

RP
RQ
RO
RE
RF
RPH
EX
TR.
EO..
VO
SUMX
CHV
CHF
HRV
HRZ
PRI

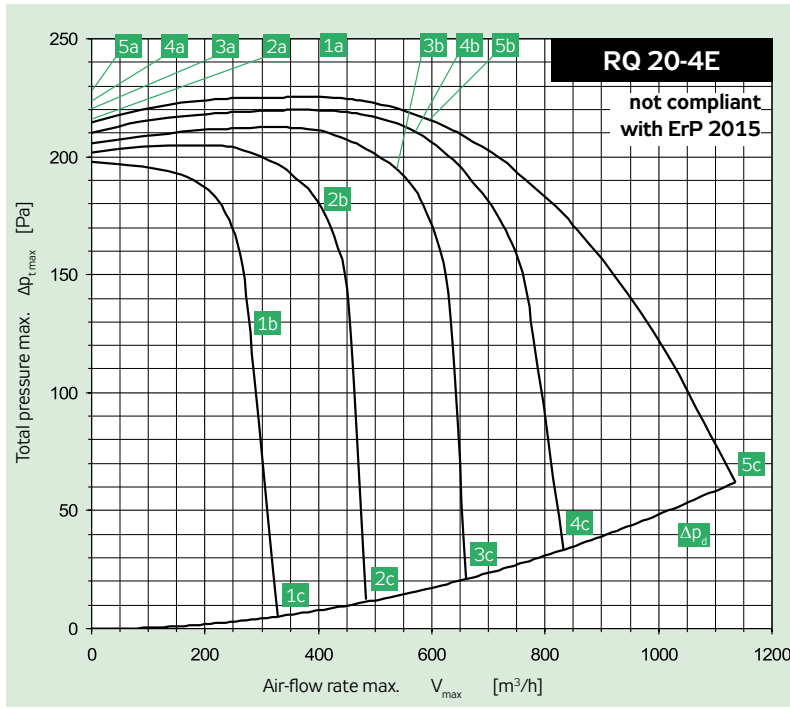

Parameters in selected points	5a	5b	5c	4a	4b	4c	3a	3b	3c	2a	2b	2c	1a	1b	1c
Voltage U [V]	230			180			160			130			105		
Current I [A]	0.89	0.95	1.47	0.51	0.75	1.21	0.50	0.77	0.95	0.46	0.72	0.83	0.46	0.64	0.77
Electric input P [W]	126	176	303	82	133	200	77	115	142	58	88	98	47	62	70
Speed n [min ⁻¹]	1447	1403	1251	1438	1371	1175	1431	1349	1258	1415	1304	1236	1376	1260	1122
Air-flow rate V [m ³ /h]	0	602	1135	0	575	830	0	542	660	0	432	483	0	277	328
Static pressure Δp _s [Pa]	214	198	0	210	195	0	204	181	0	201	163	0	198	130	0
Total pressure Δp _t [Pa]	214	216	62	210	211	33	206	195	21	202	168	6	199	133	4

Power supply	Y	230 V	50 Hz
Max. electric input	P _{max}	[W]	303
Max. current (5c)	I _{max}	[A]	1.47
Mean speed	n	[min ⁻¹]	1400
Capacitor	C	[F]	5
Max. working temp.	t _{max}	[°C]	40
Max. air-flow rate	V _{max}	[m ³ /h]	1135
Max. total pressure	Δp _{t max}	[Pa]	225
Min. static pressure (5c)	Δp _{s min}	[Pa]	0
Weight	m	[kg]	9
Five-stage controller	type		TRN 2E
Protecting relay	type		STE

	Sání	Výtlak	Okolí
Bod	5b	5b	5b
Total sound power level L _{MAX} [dB(A)]			
L _{WA}	72	76	64
Sound power level L _{WAKokt} [dB(A)]			
125 Hz	55	52	46
250 Hz	65	64	60
500 Hz	63	69	58
1000 Hz	65	72	57
2000 Hz	66	69	54
4000 Hz	64	67	50
8000 Hz	55	59	40

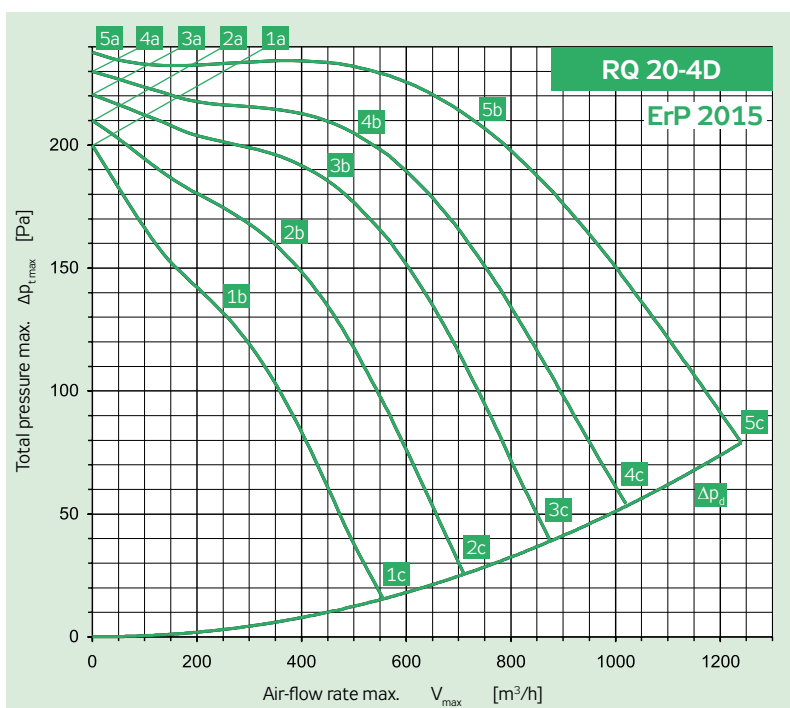

Parameters in selected points	5a	5b	5c	4a	4b	4c	3a	3b	3c	2a	2b	2c	1a	1b	1c
Voltage U [V]	400			280			230			180			140		
Current I [A]	0.30	0.34	0.49	0.19	0.26	0.48	0.17	0.24	0.46	0.16	0.24	0.41	0.16	0.22	0.35
Electric input P [W]	74	158	290	48	96	208	45	81	166	39	66	118	34	49	77
Speed n [min ⁻¹]	1438	1347	1194	1404	1302	975	1370	1248	854	1310	1147	695	1216	1024	548
Air-flow rate V [m ³ /h]	0	735	1240	0	503	1020	0	436	875	0	367	710	0	291	555
Static pressure Δp _s [Pa]	237	183	0	229	191	0	220	177	0	209	150	0	200	117	0
Total pressure Δp _t [Pa]	238	211	79	230	204	54	221	187	39	210	157	26	200	122	16

Power supply	Y	3 × 400 V	50 Hz
Max. electric input	P _{max}	[W]	290
Max. current (5c)	I _{max}	[A]	0.49
Mean speed	n	[min ⁻¹]	1350
Capacitor	C	[F]	-
Max. working temp.	t _{max}	[°C]	70
Max. air-flow rate	V _{max}	[m ³ /h]	1240
Max. total pressure	Δp _{t max}	[Pa]	238
Min. static pressure (5c)	Δp _{s min}	[Pa]	0
Weight	m	[kg]	9
Five-stage controller	type		TRN 2D
Protecting relay	type		STD

	Sání	Výtlak	Okolí
Bod	5b	5b	5b
Total sound power level L _{MAX} [dB(A)]			
L _{WA}	71	74	62
Sound power level L _{WAKokt} [dB(A)]			
125 Hz	50	51	42
250 Hz	65	62	53
500 Hz	63	68	55
1000 Hz	63	69	58
2000 Hz	65	68	55
4000 Hz	62	64	51
8000 Hz	54	58	44

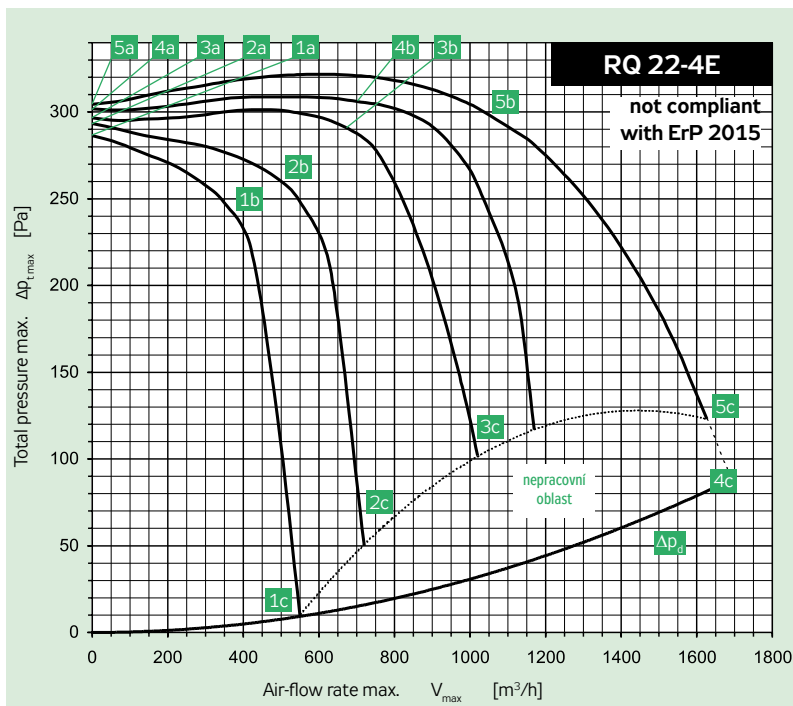

Power supply	Y	230 V	50 Hz
Max. electric input	P_{max}	[W]	508
Max. current (5c)	I_{max}	[A]	2.30
Mean speed	n	[min ⁻¹]	1380
Capacitor	C	[F]	8
Max. working temp.	t_{max}	[°C]	40
Max. air-flow rate	V_{max}	[m ³ /h]	1627
Max. total pressure	Δp_{tmax}	[Pa]	322
Min. static pressure (5c)	Δp_{smin}	[Pa]	42
Weight	m	[kg]	14
Five-stage controller	type		TRN 4E
Protecting relay	type		STE

	Sání	Výtlak	Okolí
Bod	5b	5b	5b
Total sound power level L_{MAX} [dB(A)]			
L_{WA}	77	79	67
Sound power level L_{WAKokt} [dB(A)]			
125 Hz	58	54	49
250 Hz	70	66	64
500 Hz	67	69	59
1000 Hz	70	75	60
2000 Hz	71	72	57
4000 Hz	69	71	55
8000 Hz	61	63	46

Parameters in selected points	5a	5b	5c	4a	4b	4c	3a	3b	3c	2a	2b	2c	1a	1b	1c
Voltage U [V]	230			180			160			130			105		
Current I [A]	1.07	1.47	2.30	0.73	1.11	2.25	0.69	1.12	2.20	0.71	1.05	2.10	0.71	1.02	1.74
Electric input P [W]	192	320	508	128	202	380	115	182	324	90	136	239	78	108	157
Speed n [min ⁻¹]	1446	1379	1244	1435	1376	1057	1425	1349	931	1401	1318	603	1365	1255	420
Air-flow rate V [m ³ /h]	0	1050	1627	0	700	1160	0	668	1016	0	506	724	0	385	549
Static pressure Δp_s [Pa]	303	263	42	300	293	76	298	276	69	294	251	33	286	236	0
Total pressure Δp_t [Pa]	304	297	123	301	308	118	298	290	100	295	258	50	287	240	10

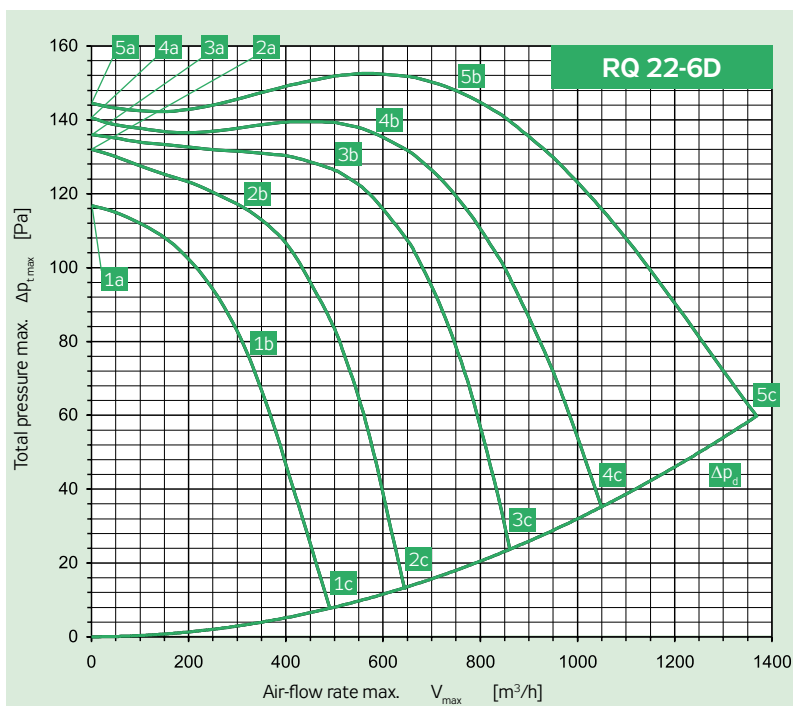

Power supply	Y	3 × 400 V	50 Hz
Max. electric input	P_{max}	[W]	233
Max. current (5c)	I_{max}	[A]	0.46
Mean speed	n	[min ⁻¹]	920
Capacitor	C	[F]	-
Max. working temp.	t_{max}	[°C]	55
Max. air-flow rate	V_{max}	[m ³ /h]	1370
Max. total pressure	Δp_{tmax}	[Pa]	153
Min. static pressure (5c)	Δp_{smin}	[Pa]	0
Weight	m	[kg]	11
Five-stage controller	type		TRN 2D
Protecting relay	type		STD

	Sání	Výtlak	Okolí
Bod	5b	5b	5b
Total sound power level L_{MAX} [dB(A)]			
L_{WA}	66	68	57
Sound power level L_{WAKokt} [dB(A)]			
125 Hz	48	46	40
250 Hz	60	58	51
500 Hz	59	62	52
1000 Hz	59	62	50
2000 Hz	60	61	48
4000 Hz	56	59	44
8000 Hz	46	50	39

Parameters in selected points	5a	5b	5c	4a	4b	4c	3a	3b	3c	2a	2b	2c	1a	1b	1c
Voltage U [V]	400			280			230			180			140		
Current I [A]	0.30	0.32	0.46	0.20	0.24	0.44	0.17	0.22	0.41	0.14	0.18	0.34	0.13	0.17	0.28
Electric input P [W]	56	114	233	37	76	162	30	61	121	26	41	76	22	32	47
Speed n [min ⁻¹]	964	924	809	953	885	617	945	865	533	920	844	415	872	778	313
Air-flow rate V [m ³ /h]	0	723	1370	0	586	1050	0	501	860	0	319	645	0	243	490
Static pressure Δp_s [Pa]	145	133	0	141	125	0	136	118	0	132	111	0	117	92	0
Total pressure Δp_t [Pa]	145	150	60	141	136	35	136	126	24	132	114	14	117	94	8

RP

RQ

RO

RE

RF

RPH

EX

TR.

EO..

VO

SUMX

CHV

CHF

HRV

HRZ

PRI

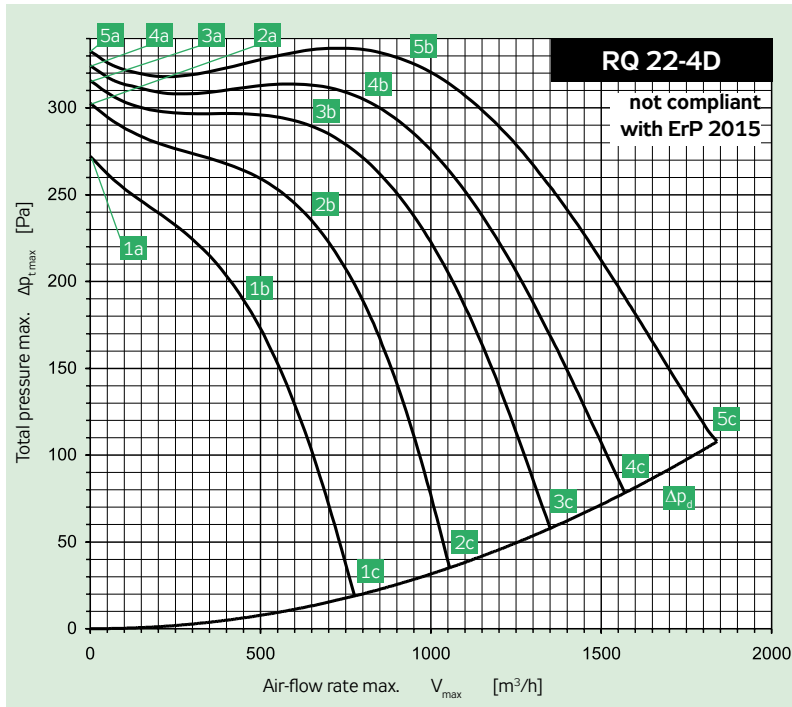

Power supply	Y	3 × 400 V	50 Hz
Max. electric input	P_{max}	[W]	535
Max. current (5c)	I_{max}	[A]	0.94
Mean speed	n	[min ⁻¹]	1410
Capacitor	C	[F]	-
Max. working temp.	t_{max}	[°C]	40
Max. air-flow rate	V_{max}	[m ³ /h]	1840
Max. total pressure	$\Delta p_{t,max}$	[Pa]	334
Min. static pressure (5c)	$\Delta p_{s,min}$	[Pa]	0
Weight	m	[kg]	14
Five-stage controller	type		TRN 2D
Protecting relay	type		STD

	Sání	Výtlač	Okolí
Bod	5b	5b	5b
Total sound power level L_{MAX} [dB(A)]			
L_{WA}	66	68	57
Sound power level L_{WAKokt} [dB(A)]			
125 Hz	48	46	40
250 Hz	60	58	51
500 Hz	59	62	52
1000 Hz	59	62	50
2000 Hz	60	61	48
4000 Hz	56	59	44
8000 Hz	46	50	39

Parameters in selected points	5a	5b	5c	4a	4b	4c	3a	3b	3c	2a	2b	2c	1a	1b	1c
Voltage U [V]	400			280			230			180			140		
Current I [A]	0.58	0.63	0.94	0.32	0.48	1.00	0.27	0.46	1.02	0.26	0.53	0.97	0.28	0.52	0.81
Electric input P [W]	111	249	535	76	190	438	67	156	373	63	146	260	59	111	166
Speed n [min ⁻¹]	1453	1407	1299	1437	1358	1117	1419	1324	956	1385	1203	761	1313	1086	576
Air-flow rate V [m ³ /h]	0	938	1840	0	784	1570	0	647	1349	0	645	1050	0	451	775
Static pressure Δp_s [Pa]	332	300	0	324	287	0	315	274	0	302	223	0	272	180	0
Total pressure Δp_t [Pa]	332	328	108	324	306	78	315	287	58	302	236	36	272	187	19

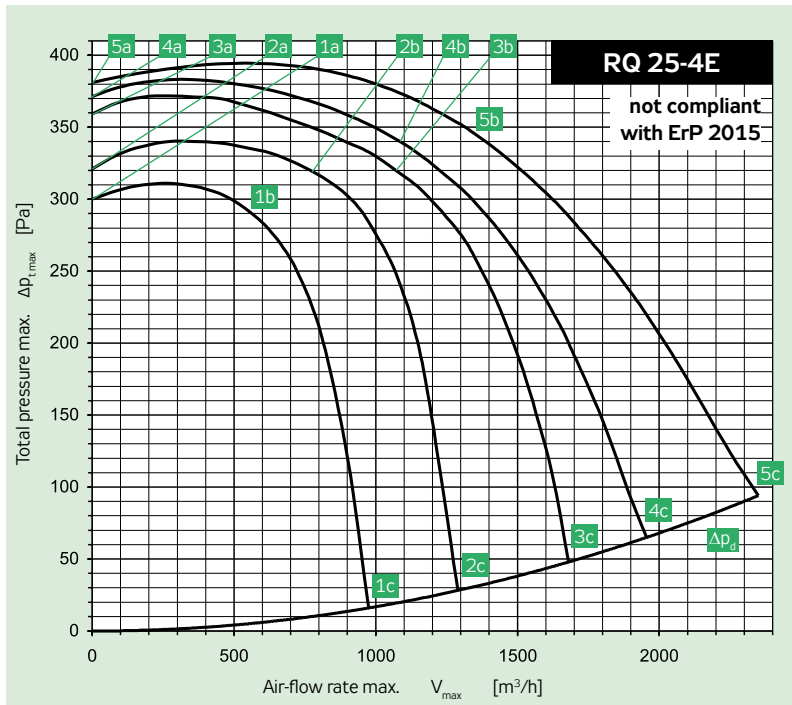

Power supply	Y	230 V	50 Hz
Max. electric input	P_{max}	[W]	861
Max. current (5c)	I_{max}	[A]	3.85
Mean speed	n	[min ⁻¹]	1370
Capacitor	C	[F]	14
Max. working temp.	t_{max}	[°C]	55
Max. air-flow rate	V_{max}	[m ³ /h]	2350
Max. total pressure	$\Delta p_{t,max}$	[Pa]	394
Min. static pressure (5c)	$\Delta p_{s,min}$	[Pa]	0
Weight	m	[kg]	17
Five-stage controller	type		TRN 4E
Protecting relay	type		STE

	Sání	Výtlač	Okolí
Bod	5b	5b	5b
Total sound power level L_{MAX} [dB(A)]			
L_{WA}	82	81	71
Sound power level L_{WAKokt} [dB(A)]			
125 Hz	67	59	59
250 Hz	75	71	67
500 Hz	75	74	64
1000 Hz	73	76	64
2000 Hz	74	74	62
4000 Hz	75	72	58
8000 Hz	72	63	48

Parameters in selected points	5a	5b	5c	4a	4b	4c	3a	3b	3c	2a	2b	2c	1a	1b	1c
Voltage U [V]	230			180			160			140			105		
Current I [A]	1.56	2.26	3.85	1.14	1.97	4.08	1.12	2.09	3.92	1.13	1.82	3.66	1.13	1.61	3.08
Electric input P [W]	320	503	861	209	354	702	180	335	591	148	241	448	122	170	298
Speed n [min ⁻¹]	1431	1365	1204	1425	1340	990	1414	1293	884	1384	1273	683	1345	1237	504
Air-flow rate V [m ³ /h]	0	1346	2350	0	1040	1955	0	1059	1680	0	764	1290	0	538	975
Static pressure Δp_s [Pa]	377	314	0	370	328	0	359	301	0	321	308	0	299	290	0
Total pressure Δp_t [Pa]	380	345	94	370	346	65	360	320	48	321	318	29	300	295	17

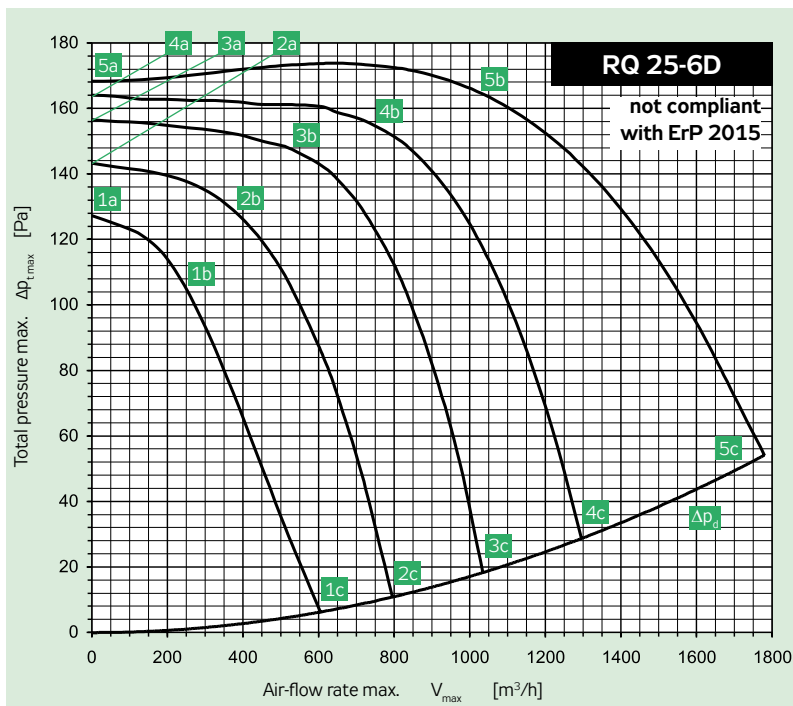

Power supply	Y	3 × 400 V	50 Hz
Max. electric input	P_{max}	[W]	337
Max. current (5c)	I_{max}	[A]	0.70
Mean speed	n	[min ⁻¹]	910
Capacitor	C	[F]	-
Max. working temp.	t_{max}	[°C]	55
Max. air-flow rate	V_{max}	[m ³ /h]	1780
Max. total pressure	$\Delta p_{t max}$	[Pa]	174
Min. static pressure (5c)	$\Delta p_{s min}$	[Pa]	0
Weight	m	[kg]	14
Five-stage controller	type		TRN 2D
Protecting relay	type		STD

	Sání	Výtlač	Okolí
Bod	5b	5b	5b
Total sound power level L_{MAX} [dB(A)]			
L_{WA}	67	69	60
Sound power level L_{WAKokt} [dB(A)]			
125 Hz	50	46	45
250 Hz	57	60	51
500 Hz	60	63	55
1000 Hz	61	64	54
2000 Hz	62	62	53
4000 Hz	58	60	45
8000 Hz	48	48	43

Parameters in selected points	5a	5b	5c	4a	4b	4c	3a	3b	3c	2a	2b	2c	1a	1b	1c
Voltage U [V]	400			280			230			180			140		
Current I [A]	0.44	0.49	0.70	0.29	0.38	0.65	0.25	0.31	0.57	0.23	0.27	0.47	0.21	0.24	0.37
Electric input P [W]	83	173	337	56	113	227	47	78	155	43	56	98	35	41	59
Speed n [min ⁻¹]	969	913	786	950	870	568	933	865	464	887	829	351	823	771	279
Air-flow rate V [m ³ /h]	0	1025	1780	0	750	1295	0	523	1035	0	375	795	0	244	602
Static pressure Δp_s [Pa]	169	149	0	163	143	0	156	142	0	143	125	0	126	108	0
Total pressure Δp_t [Pa]	169	167	54	164	153	29	156	148	18	143	127	11	127	109	6

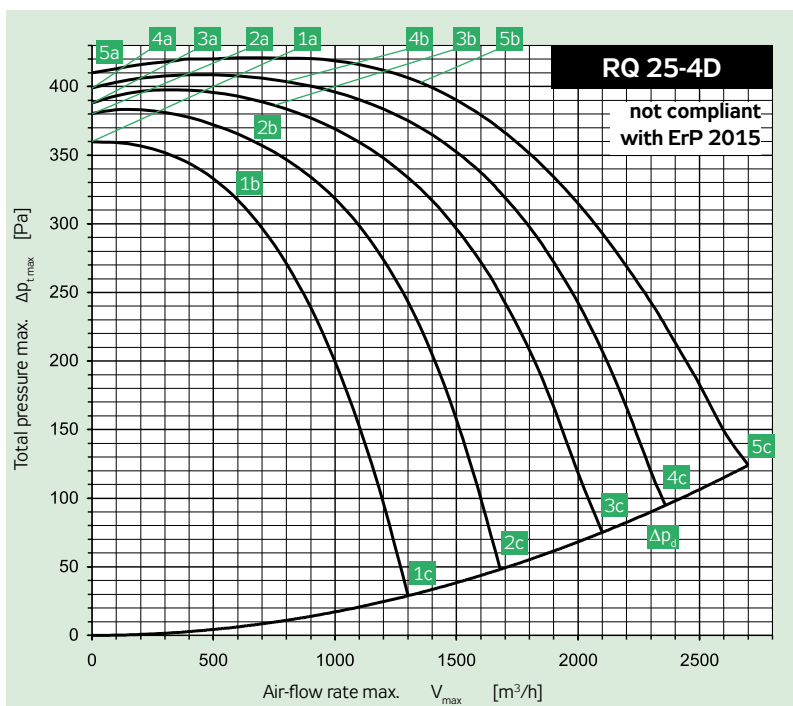

Power supply	Y	3 × 400 V	50 Hz
Max. electric input	P_{max}	[W]	1058
Max. current (5c)	I_{max}	[A]	1.98
Mean speed	n	[min ⁻¹]	1430
Capacitor	C	[F]	-
Max. working temp.	t_{max}	[°C]	50
Max. air-flow rate	V_{max}	[m ³ /h]	2701
Max. total pressure	$\Delta p_{t max}$	[Pa]	421
Min. static pressure (5c)	$\Delta p_{s min}$	[Pa]	0
Weight	m	[kg]	15
Five-stage controller	type		TRN 2D
Protecting relay	type		STD

	Sání	Výtlač	Okolí
Bod	5b	5b	5b
Total sound power level L_{MAX} [dB(A)]			
L_{WA}	80	83	70
Sound power level L_{WAKokt} [dB(A)]			
125 Hz	63	59	54
250 Hz	70	70	62
500 Hz	71	76	64
1000 Hz	74	78	64
2000 Hz	75	77	63
4000 Hz	72	75	59
8000 Hz	65	67	49

Parameters in selected points	5a	5b	5c	4a	4b	4c	3a	3b	3c	2a	2b	2c	1a	1b	1c
Voltage U [V]	400			280			230			180			140		
Current I [A]	1.28	1.37	1.98	0.69	0.83	2.10	0.57	0.77	2.20	0.53	0.77	2.10	0.50	0.84	1.83
Electric input P [W]	211	484	1058	134	263	872	121	234	757	109	200	542	99	180	357
Speed n [min ⁻¹]	1466	1428	1344	1454	1420	1197	1444	1395	1060	1419	1350	849	1381	1265	679
Air-flow rate V [m ³ /h]	0	1347	2701	0	799	2360	0	741	2100	0	643	1680	0	600	1300
Static pressure Δp_s [Pa]	411	371	0	400	392	0	389	379	0	380	354	0	360	312	0
Total pressure Δp_t [Pa]	411	402	124	400	403	95	389	388	75	380	361	49	360	318	29

RP
RQ
RO
RE
RF
RPH
EX
TR.
EO..
VO
SUMX
CHV
CHF
HRV
HRZ
PRI

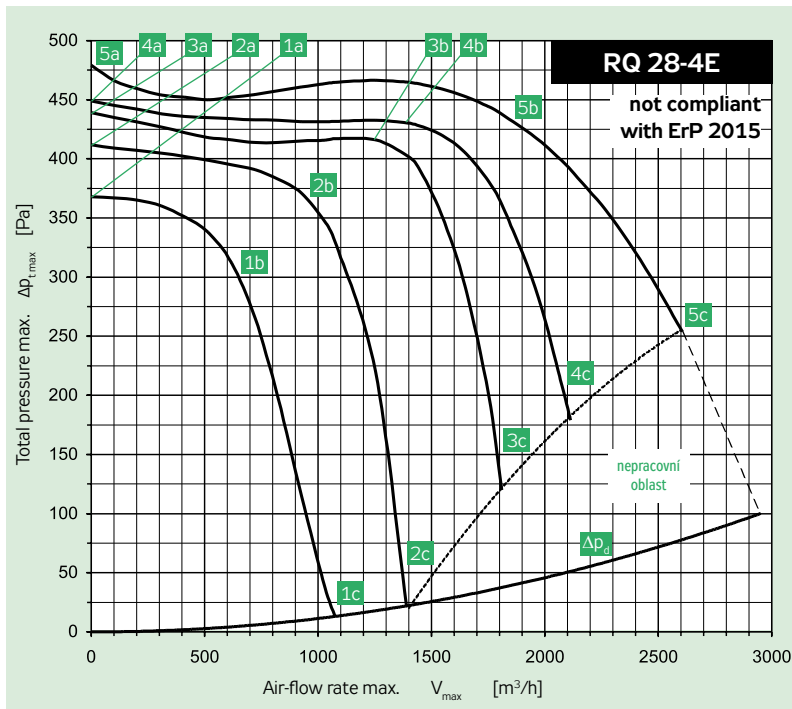

Power supply	Y	230 V	50 Hz
Max. electric input	P_{max}	[W]	1079
Max. current (5c)	I_{max}	[A]	5.10
Mean speed	n	[min ⁻¹]	1370
Capacitor	C	[F]	16
Max. working temp.	t_{max}	[°C]	40
Max. air-flow rate	V_{max}	[m ³ /h]	2607
Max. total pressure	$\Delta p_{t max}$	[Pa]	479
Min. static pressure (5c)	$\Delta p_{s min}$	[Pa]	176
Weight	m	[kg]	23
Five-stage controller	type		TRN 7E
Protecting relay	type		STE

	Sání	Výtlačk	Okolí
Bod	5b	5b	5b
Total sound power level L_{MAX} [dB(A)]			
L_{WA}	82	84	72
Sound power level L_{WAKokt} [dB(A)]			
125 Hz	69	60	58
250 Hz	71	73	65
500 Hz	72	76	64
1000 Hz	77	80	68
2000 Hz	77	78	64
4000 Hz	73	76	61
8000 Hz	65	68	51

Parameters in selected points	5a	5b	5c	4a	4b	4c	3a	3b	3c	2a	2b	2c	1a	1b	1c
Voltage U [V]	230			180			160			130			105		
Current I [A]	2.48	3.70	5.10	1.88	3.04	5.10	1.88	2.97	5.10	1.83	2.80	4.49	1.83	2.61	3.62
Electric input P [W]	448	783	1079	335	544	843	300	471	718	240	360	495	194	262	316
Speed n [min ⁻¹]	1447	1371	1271	1430	1342	1062	1417	1310	845	1389	1249	560	1338	1146	434
Air-flow rate V [m ³ /h]	0	1850	2607	0	1392	2114	0	1261	1800	0	974	1390	0	666	1075
Static pressure Δp_s [Pa]	477	398	176	450	405	128	441	400	55	412	351	0	370	291	0
Total pressure Δp_t [Pa]	478	437	254	450	428	179	441	418	120	412	362	23	370	296	13

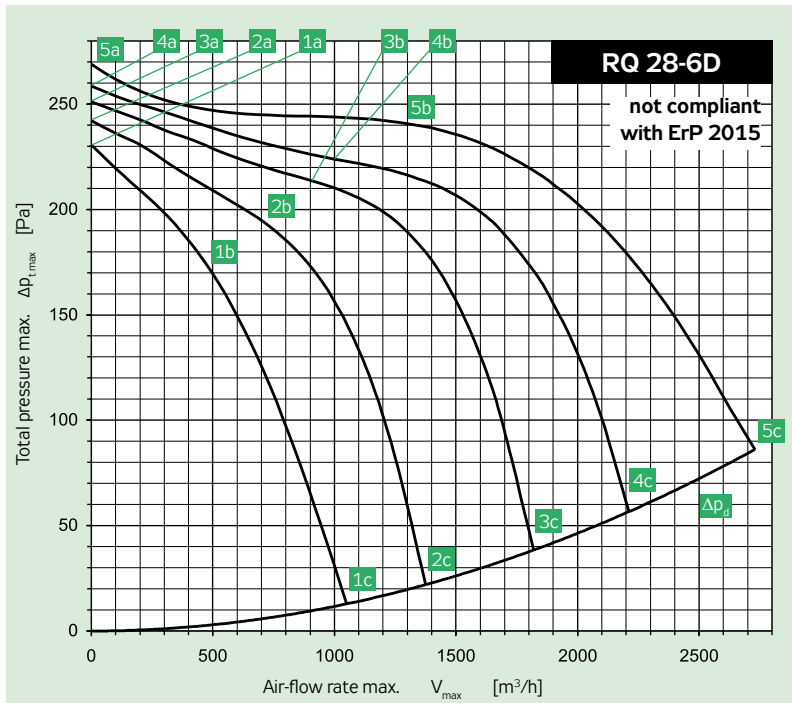

Power supply	Y	3 × 400 V	50 Hz
Max. electric input	P_{max}	[W]	643
Max. current (5c)	I_{max}	[A]	1.37
Mean speed	n	[min ⁻¹]	950
Capacitor	C	[F]	-
Max. working temp.	t_{max}	[°C]	55
Max. air-flow rate	V_{max}	[m ³ /h]	2730
Max. total pressure	$\Delta p_{t max}$	[Pa]	269
Min. static pressure (5c)	$\Delta p_{s min}$	[Pa]	0
Weight	m	[kg]	17
Five-stage controller	type		TRN 2D
Protecting relay	type		STD

	Sání	Výtlačk	Okolí
Bod	5b	5b	5b
Total sound power level L_{MAX} [dB(A)]			
L_{WA}	71	74	62
Sound power level L_{WAKokt} [dB(A)]			
125 Hz	56	52	47
250 Hz	60	62	54
500 Hz	65	69	58
1000 Hz	65	68	55
2000 Hz	65	66	53
4000 Hz	62	65	49
8000 Hz	54	55	41

Parameters in selected points	5a	5b	5c	4a	4b	4c	3a	3b	3c	2a	2b	2c	1a	1b	1c
Voltage U [V]	400			280			230			180			140		
Current I [A]	0.88	0.96	1.37	0.59	0.71	1.38	0.49	0.65	1.32	0.43	0.61	1.12	0.39	0.56	0.92
Electric input P [W]	130	271	643	90	187	487	73	162	366	69	130	230	59	94	136
Speed n [min ⁻¹]	975	946	866	966	924	713	957	900	581	937	861	440	903	805	343
Air-flow rate V [m ³ /h]	0	1280	2730	0	995	2210	0	906	1820	0	708	1375	0	491	1050
Static pressure Δp_s [Pa]	269	213	0	259	214	0	251	204	0	241	178	0	230	166	0
Total pressure Δp_t [Pa]	269	242	86	259	226	57	251	214	39	241	184	22	230	169	13

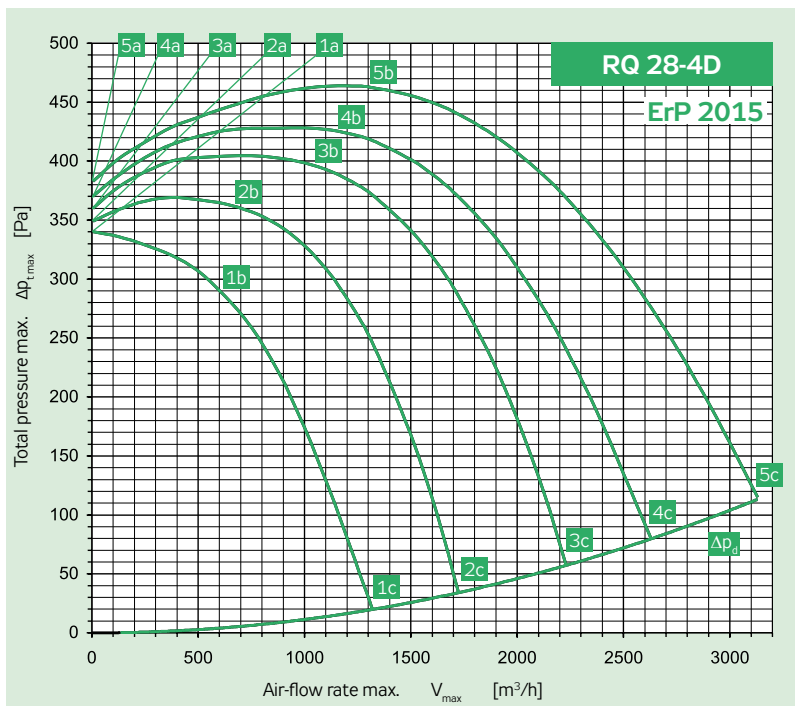

Power supply	Y	3 × 400 V	50 Hz
Max. electric input	P_{max}	[W]	1278
Max. current (5c)	I_{max}	[A]	2.22
Mean speed	n	[min ⁻¹]	1420
Capacitor	C	[F]	-
Max. working temp.	t_{max}	[°C]	40
Max. air-flow rate	V_{max}	[m ³ /h]	3130
Max. total pressure	Δp_{tmax}	[Pa]	464
Min. static pressure (5c)	Δp_{cmin}	[Pa]	0
Weight	m	[kg]	23
Five-stage controller	type		TRN 4D
Protecting relay	type		STD

	Sání	Výtlak	Okolí
Bod	5b	5b	5b
Total sound power level L_{MAX} [dB(A)]			
L_{WA}	80	82	69
Sound power level L_{WAKokt} [dB(A)]			
125 Hz	66	60	55
250 Hz	68	69	62
500 Hz	70	74	61
1000 Hz	75	77	63
2000 Hz	75	76	61
4000 Hz	71	74	58
8000 Hz	63	65	48

Parameters in selected points	5a	5b	5c	4a	4b	4c	3a	3b	3c	2a	2b	2c	1a	1b	1c
Voltage U [V]		400			280			230			180			140	
Current I [A]	1.01	1.16	2.22	0.72	1.01	2.50	0.63	1.03	2.48	0.69	0.89	2.26	0.76	1.05	1.92
Electric input P [W]	252	484	1278	205	393	1044	193	361	833	176	247	567	157	226	364
Speed n [min ⁻¹]	1452	1418	1286	1426	1365	1076	1406	1320	917	1357	1301	720	1281	1152	544
Air-flow rate V [m ³ /h]	0	1305	3130	0	1158	2630	0	1053	2230	0	661	1725	0	616	1320
Static pressure Δp_s [Pa]	381	442	0	370	409	0	360	384	0	299	357	0	340	284	0
Total pressure Δp_t [Pa]	382	462	113	370	425	80	360	397	58	300	362	34	340	288	20

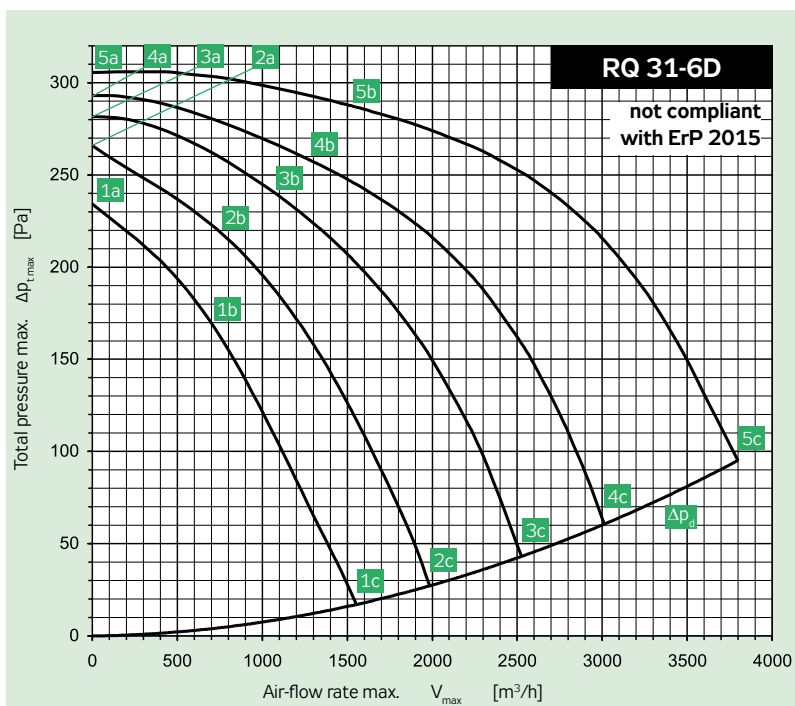

Power supply	Y	3 × 400 V	50 Hz
Max. electric input	P_{max}	[W]	946
Max. current (5c)	I_{max}	[A]	1.82
Mean speed	n	[min ⁻¹]	920
Capacitor	C	[F]	-
Max. working temp.	t_{max}	[°C]	40
Max. air-flow rate	V_{max}	[m ³ /h]	3798
Max. total pressure	Δp_{tmax}	[Pa]	306
Min. static pressure (5c)	Δp_{cmin}	[Pa]	0
Weight	m	[kg]	23
Five-stage controller	type		TRN 2D
Protecting relay	type		STD

	Sání	Výtlak	Okolí
Bod	5b	5b	5b
Total sound power level L_{MAX} [dB(A)]			
L_{WA}	74	76	63
Sound power level L_{WAKokt} [dB(A)]			
125 Hz	58	54	50
250 Hz	61	63	58
500 Hz	67	71	56
1000 Hz	68	71	57
2000 Hz	67	69	55
4000 Hz	66	69	48
8000 Hz	55	56	44

Parameters in selected points	5a	5b	5c	4a	4b	4c	3a	3b	3c	2a	2b	2c	1a	1b	1c
Voltage U [V]		400			280			230			180			140	
Current I [A]	1.11	1.17	1.82	0.63	0.79	1.64	0.54	0.73	1.49	0.48	0.64	1.29	0.47	0.66	1.06
Electric input P [W]	189	373	946	117	261	639	105	205	471	99	156	310	80	124	201
Speed n [min ⁻¹]	968	924	766	949	878	601	931	852	510	896	817	410	845	728	323
Air-flow rate V [m ³ /h]	0	1510	3798	0	1266	3010	0	1055	2525	0	776	1985	0	691	1555
Static pressure Δp_s [Pa]	305	272	0	292	247	0	281	232	0	264	215	0	232	168	0
Total pressure Δp_t [Pa]	305	288	95	292	258	61	281	240	43	264	219	27	232	171	18

RP
RQ
RO
RE
RF
RPH
EX
TR.
EO..
VO
SUMX
CHV
CHF
HRV
HRZ
PRI

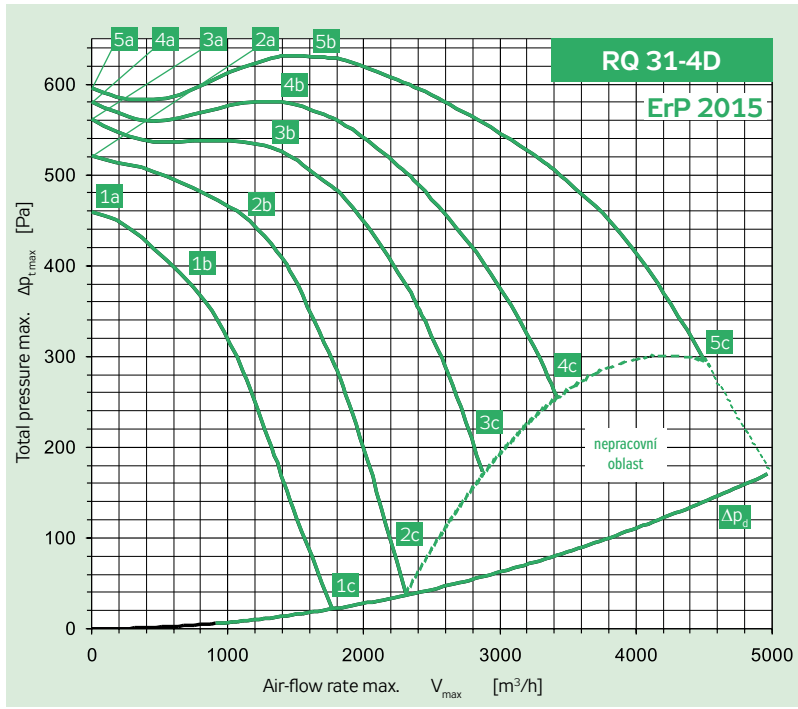

Parameters in selected points	5a	5b	5c	4a	4b	4c	3a	3b	3c	2a	2b	2c	1a	1b	1c
Voltage U [V]	400						230			180			140		
Current I [A]	1.22	1.71	4.10	0.91	1.53	4.10	0.86	1.61	4.10	0.94	1.87	3.96	1.08	1.65	3.25
Electric input P [W]	327	852	2494	300	642	1746	265	572	1389	255	528	983	237	360	603
Speed n [min ⁻¹]	1457	1408	1231	1433	1364	1039	1412	1315	865	1372	1205	567	1296	1152	437
Air-flow rate V [m ³ /h]	0	1879	4482	0	1393	3426	0	1284	2863	0	1171	2310	0	702	1770
Static pressure Δp _s [Pa]	596	605	157	572	569	174	547	520	116	520	438	0	467	380	0
Total pressure Δp _t [Pa]	596	629	296	572	582	255	547	532	173	520	447	37	467	383	22

Power supply	Y	3 × 400 V	50 Hz
Max. electric input	P _{max}	[W]	2494
Max. current (5c)	I _{max}	[A]	4.10
Mean speed	n	[min ⁻¹]	1410
Capacitor	C	[F]	-
Max. working temp.	t _{max}	[°C]	40
Max. air-flow rate	V _{max}	[m ³ /h]	4482
Max. total pressure	Δ p _{t max}	[Pa]	596
Min. static pressure (5c)	Δ p _{s min}	[Pa]	157
Weight	m	[kg]	30
Five-stage controller	type		TRN 7D
Protecting relay	type		STD

	Sání	Výtlak	Okolí
Bod	5b	5b	5b
Total sound power level L _{MAX} [dB(A)]			
L _{WA}	68	72	62
Sound power level L _{WAKokt} [dB(A)]			
125 Hz	68	63	59
250 Hz	70	73	66
500 Hz	73	78	65
1000 Hz	80	82	68
2000 Hz	78	80	65
4000 Hz	75	78	62
8000 Hz	68	69	50

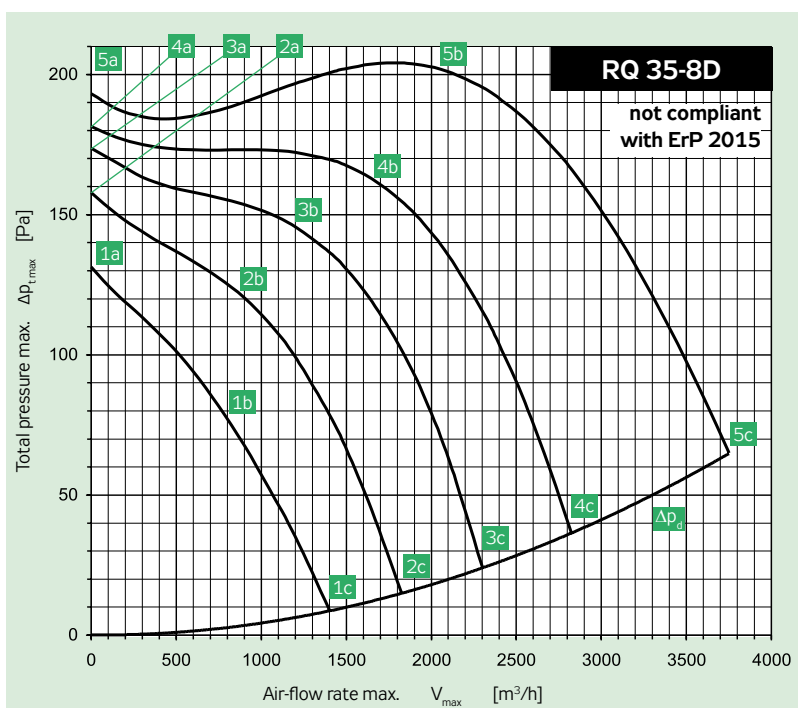

Parameters in selected points	5a	5b	5c	4a	4b	4c	3a	3b	3c	2a	2b	2c	1a	1b	1c
Voltage U [V]	400						230			180			140		
Current I [A]	0.83	0.94	1.40	0.54	0.75	1.19	0.46	0.62	1.02	0.42	0.55	0.86	0.40	0.54	0.69
Electric input P [W]	159	336	672	109	237	407	92	166	284	75	114	177	61	89	107
Speed n [min ⁻¹]	714	654	514	698	605	386	678	589	316	644	556	252	581	435	201
Air-flow rate V [m ³ /h]	0	2022	3723	0	1637	2825	0	1177	2300	0	842	1823	0	792	1400
Static pressure Δp _s [Pa]	193	182	5	182	151	0	173	140	0	158	121	0	131	74	0
Total pressure Δp _t [Pa]	193	201	67	182	163	37	173	146	24	158	124	15	131	77	9

Power supply	Y	3 × 400 V	50 Hz
Max. electric input	P _{max}	[W]	672
Max. current (5c)	I _{max}	[A]	1.40
Mean speed	n	[min ⁻¹]	650
Capacitor	C	[F]	-
Max. working temp.	t _{max}	[°C]	55
Max. air-flow rate	V _{max}	[m ³ /h]	3723
Max. total pressure	Δ p _{t max}	[Pa]	204
Min. static pressure (5c)	Δ p _{s min}	[Pa]	5
Weight	m	[kg]	37
Five-stage controller	type		TRN 2D
Protecting relay	type		STD

	Sání	Výtlak	Okolí
Bod	5b	5b	5b
Total sound power level L _{MAX} [dB(A)]			
L _{WA}	69	72	62
Sound power level L _{WAKokt} [dB(A)]			
125 Hz	55	48	45
250 Hz	60	62	59
500 Hz	63	68	55
1000 Hz	63	66	53
2000 Hz	63	64	50
4000 Hz	61	64	46
8000 Hz	51	51	44

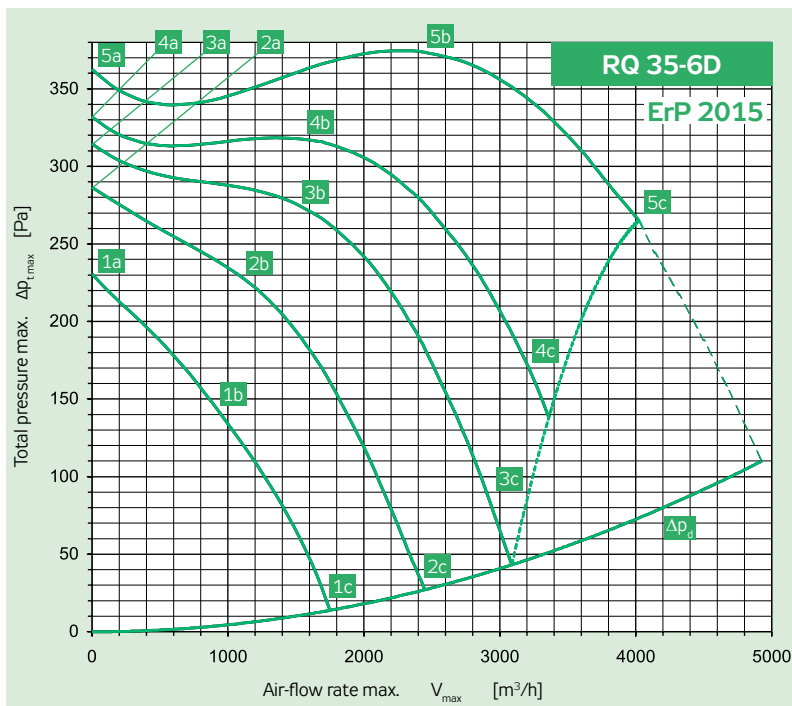

Power supply	Y	3 × 400 V	50 Hz
Max. electric input	P _{max}	[W]	1084
Max. current (5c)	I _{max}	[A]	2.00
Mean speed	n	[min ⁻¹]	890
Capacitor	C	[F]	-
Max. working temp.	t _{max}	[°C]	40
Max. air-flow rate	V _{max}	[m ³ /h]	4022
Max. total pressure	Δ p _{t,max}	[Pa]	374
Min. static pressure (5c)	Δ p _{s,min}	[Pa]	192
Weight	m	[kg]	40
Five-stage controller	type		TRN 2D
Protecting relay	type		STD

	Sání	Výtlač	Okolí
Bod	5b	5b	5b
Total sound power level L _{MAX} [dB(A)]			
L _{WA}	76	78	65
Sound power level L _{WAKokt} [dB(A)]			
125 Hz	61	55	51
250 Hz	62	66	57
500 Hz	69	73	59
1000 Hz	72	72	59
2000 Hz	69	71	56
4000 Hz	68	70	53
8000 Hz	59	61	41

Parameters in selected points	5a	5b	5c	4a	4b	4c	3a	3b	3c	2a	2b	2c	1a	1b	1c
Voltage U [V]		400			280			230			180			140	
Current I [A]	1.07	1.38	2.00	0.73	1.03	2.00	0.66	1.07	1.98	0.64	0.96	1.65	0.64	0.90	1.24
Electric input P [W]	241	629	1084	186	372	791	167	343	636	151	247	407	121	168	215
Speed n [min ⁻¹]	965	893	789	940	862	602	915	798	431	868	746	339	772	609	250
Air-flow rate V [m ³ /h]	0	2497	4022	0	1573	3360	0	1553	3088	0	1138	2450	0	881	1751
Static pressure Δp _s [Pa]	352	344	192	331	308	87	313	262	0	286	219	0	230	142	0
Total pressure Δp _t [Pa]	352	372	265	331	319	138	313	272	43	286	224	27	230	146	14

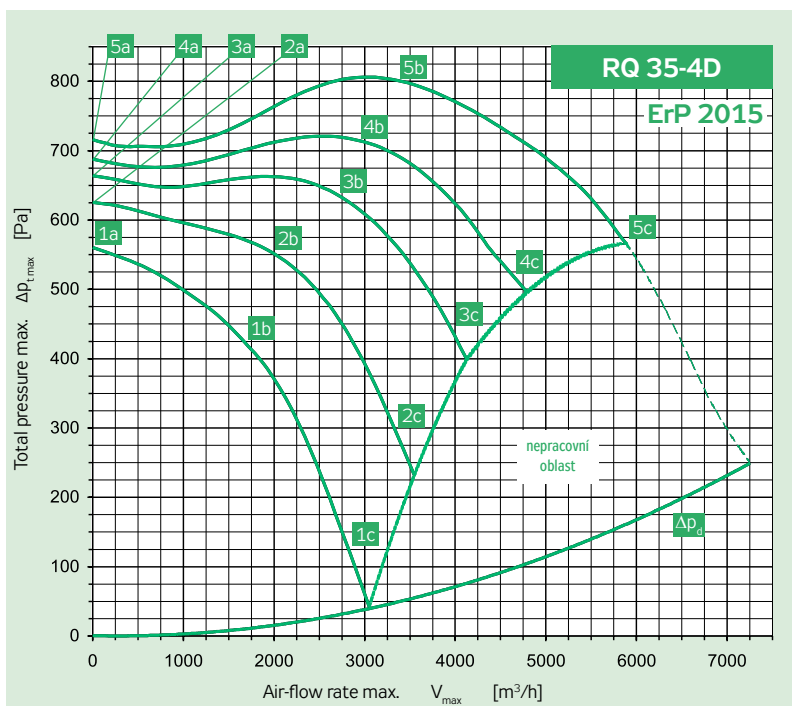

Power supply	Y	3 × 400 V	50 Hz
Max. electric input	P _{max}	[W]	3534
Max. current (5c)	I _{max}	[A]	6.00
Mean speed	n	[min ⁻¹]	1400
Capacitor	C	[F]	-
Max. working temp.	t _{max}	[°C]	40
Max. air-flow rate	V _{max}	[m ³ /h]	5886
Max. total pressure	Δ p _{t,max}	[Pa]	806
Min. static pressure (5c)	Δ p _{s,min}	[Pa]	410
Weight	m	[kg]	47
Five-stage controller	type		TRN 7D
Protecting relay	type		STD

	Sání	Výtlač	Okolí
Bod	5b	5b	5b
Total sound power level L _{MAX} [dB(A)]			
L _{WA}	87	90	76
Sound power level L _{WAKokt} [dB(A)]			
125 Hz	71	67	60
250 Hz	70	75	66
500 Hz	77	82	68
1000 Hz	84	86	72
2000 Hz	82	83	69
4000 Hz	78	81	64
8000 Hz	70	72	55

Parameters in selected points	5a	5b	5c	4a	4b	4c	3a	3b	3c	2a	2b	2c	1a	1b	1c
Voltage U [V]		400			280			230			180			140	
Current I [A]	2.07	3.24	6.00	1.50	3.15	6.00	1.46	3.43	6.00	1.57	3.36	6.00	1.82	3.44	5.74
Electric input P [W]	564	1724	3534	478	1343	2563	454	1218	2063	425	939	1575	397	728	1089
Speed n [min ⁻¹]	1330	1400	1292	1325	1340	1158	1321	1276	1036	1362	1204	829	1307	1073	526
Air-flow rate V [m ³ /h]	0	3366	5886	0	2848	4795	0	2590	4128	0	2009	3549	0	1670	3051
Static pressure Δp _s [Pa]	718	752	410	680	686	392	665	618	322	626	532	175	560	417	0
Total pressure Δp _t [Pa]	718	803	566	680	722	496	665	648	399	626	550	232	560	429	42

RP
RQ
RO
RE
RF
RPH
EX
TR.
EO..
VO
SUMX
CHV
CHF
HRV
HRZ
PRI

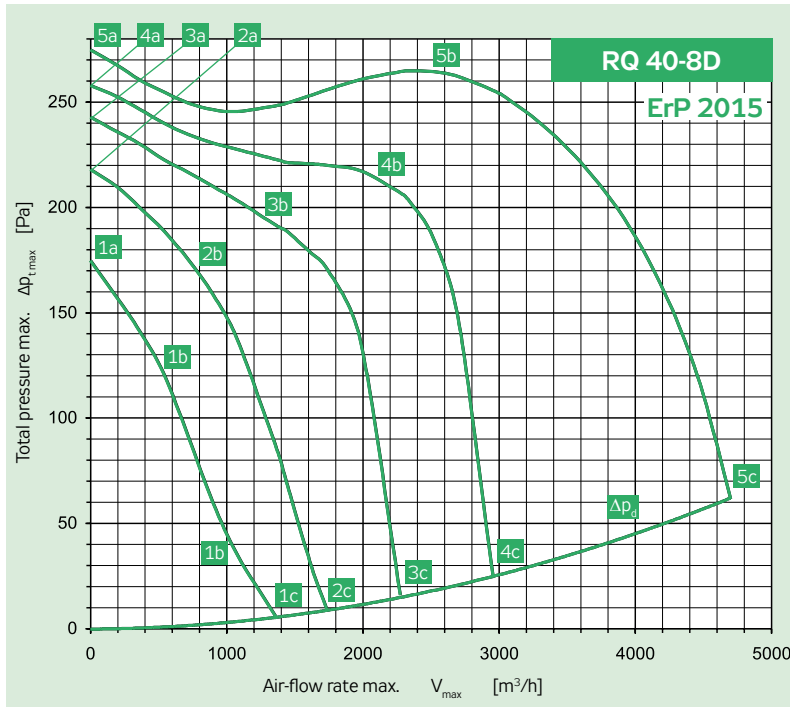

Power supply	Y	3 × 400 V	50 Hz
Max. electric input	P_{max}	[W]	303
Max. current (5c)	I_{max}	[A]	1.47
Mean speed	n	[min ⁻¹]	1400
Capacitor	C	[F]	5
Max. working temp.	t_{max}	[°C]	40
Max. air-flow rate	V_{max}	[m ³ /h]	1135
Max. total pressure	$\Delta p_{t,max}$	[Pa]	225
Min. static pressure (5c)	$\Delta p_{s,min}$	[Pa]	0
Weight	m	[kg]	9
Five-stage controller	type		TRN 2E
Protecting relay	type		STE

	Sání	Výtlač	Okolí
Bod	5b	5b	5b
Total sound power level L_{MAX} [dB(A)]			
L_{WA}	72	75	65
Sound power level L_{WAKokt} [dB(A)]			
125 Hz	60	54	52
250 Hz	59	64	57
500 Hz	67	70	59
1000 Hz	66	69	61
2000 Hz	66	68	57
4000 Hz	63	66	54
8000 Hz	51	53	45

Parameters in selected points	5a	5b	5c	4a	4b	4c	3a	3b	3c	2a	2b	2c	1a	1b	1c
Voltage U [V]		400			280			230			180			140	
Current I [A]	0.87	1.07	2.41	0.62	1.03	1.94	0.56	0.81	1.60	0.58	0.71	1.27	0.63	0.72	1.00
Electric input P [W]	221	495	1274	164	396	673	154	257	449	134	170	271	117	131	166
Speed n [min ⁻¹]	715	669	427	697	610	279	679	616	227	639	594	168	560	508	139
Air-flow rate V [m ³ /h]	0	2479	4700	0	2112	2955	0	1294	2275	0	758	1740	0	515	1370
Static pressure Δp_s [Pa]	273	250	0	258	203	0	242	189	0	218	171	0	164	124	0
Total pressure Δp_t [Pa]	274	267	62	258	215	25	242	194	18	218	173	9	164	125	6

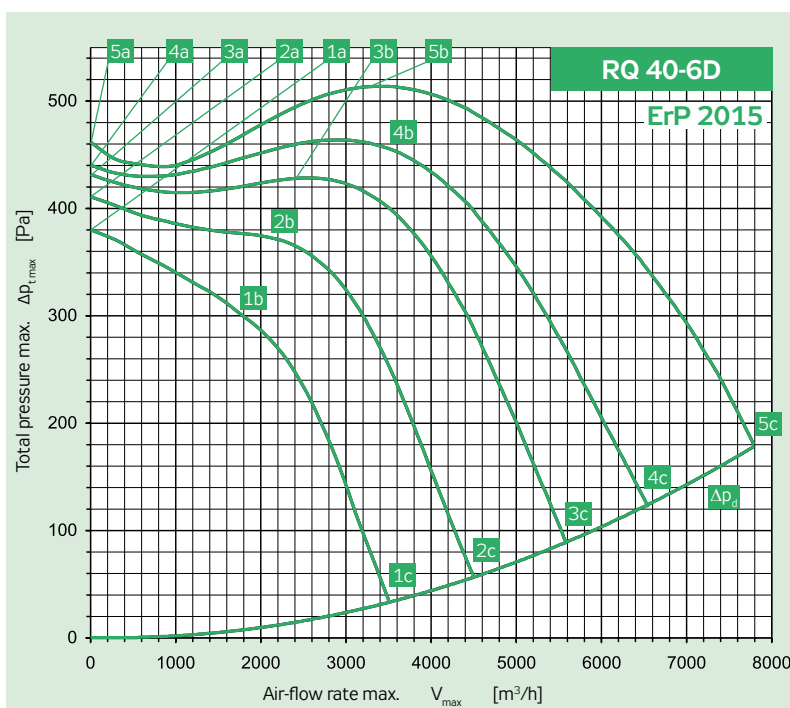

Power supply	Y	3 × 400 V	50 Hz
Max. electric input	P_{max}	[W]	2770
Max. current (5c)	I_{max}	[A]	5.10
Mean speed	n	[min ⁻¹]	940
Capacitor	C	[F]	-
Max. working temp.	t_{max}	[°C]	50
Max. air-flow rate	V_{max}	[m ³ /h]	7800
Max. total pressure	$\Delta p_{t,max}$	[Pa]	514
Min. static pressure (5c)	$\Delta p_{s,min}$	[Pa]	0
Weight	m	[kg]	51
Five-stage controller	type		TRN 7D
Protecting relay	type		STD

	Sání	Výtlač	Okolí
Bod	5b	5b	5b
Total sound power level L_{MAX} [dB(A)]			
L_{WA}	80	83	69
Sound power level L_{WAKokt} [dB(A)]			
125 Hz	66	60	55
250 Hz	65	70	61
500 Hz	73	78	63
1000 Hz	75	77	63
2000 Hz	74	76	62
4000 Hz	70	74	55
8000 Hz	62	64	44

Parameters in selected points	5a	5b	5c	4a	4b	4c	3a	3b	3c	2a	2b	2c	1a	1b	1c
Voltage U [V]		400			280			230			180			140	
Current I [A]	2.27	2.70	5.10	1.49	2.65	5.66	1.29	2.15	5.35	1.18	2.15	4.73	1.18	2.18	3.96
Electric input P [W]	382	999	2770	302	1011	2235	271	669	1717	246	552	1134	219	438	710
Speed n [min ⁻¹]	975	939	829	962	879	665	952	878	572	932	831	453	897	754	363
Air-flow rate V [m ³ /h]	0	3236	7800	0	3509	6530	0	2424	5585	0	2083	4500	0	1768	3501
Static pressure Δp_s [Pa]	460	489	0	440	424	0	430	411	0	410	363	0	380	291	0
Total pressure Δp_t [Pa]	461	518	180	440	459	122	430	428	88	410	375	57	380	300	35

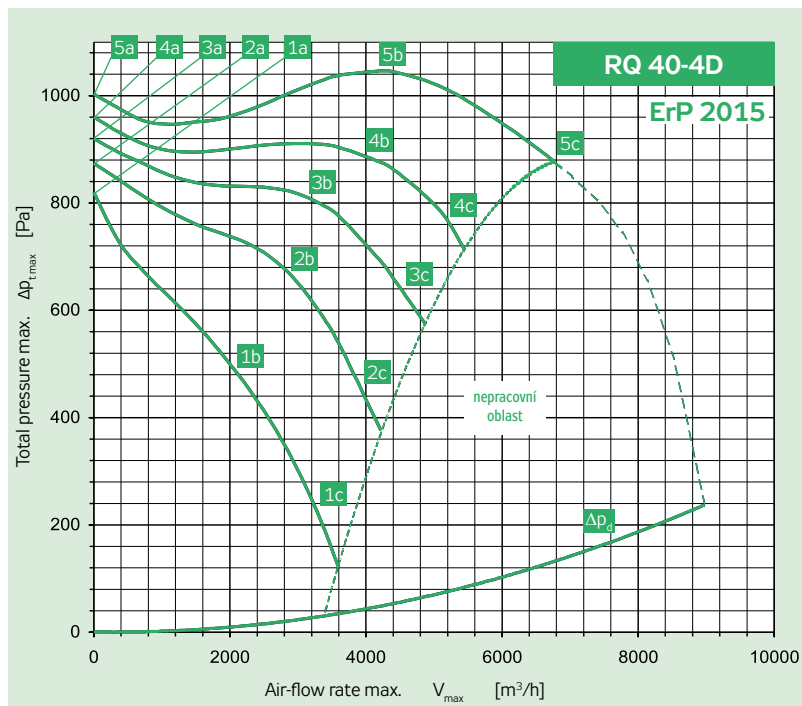

Power supply	Y	3 × 400 V	50 Hz
Max. electric input	P _{max}	[W]	4873
Max. current (5c)	I _{max}	[A]	8.10
Mean speed	n	[min ⁻¹]	1390
Capacitor	C	[F]	-
Max. working temp.	t _{max}	[°C]	40
Max. air-flow rate	V _{max}	[m ³ /h]	6768
Max. total pressure	Δ p _{t,max}	[Pa]	1047
Min. static pressure (5c)	Δ p _{c,min}	[Pa]	746
Weight	m	[kg]	58
Five-stage controller	type		TRN 9D
Protecting relay	type		STD

	Sání	Výtlačk	Okolí
Bod	5b	5b	5b
Total sound power level L _{MAX} [dB(A)]			
L _{WA}	91	94	78
Sound power level L _{WAKokt} [dB(A)]			
125 Hz	76	73	49
250 Hz	77	79	62
500 Hz	81	86	68
1000 Hz	87	90	73
2000 Hz	85	89	74
4000 Hz	82	85	68
8000 Hz	73	76	58

Parameters in selected points	5a	5b	5c	4a	4b	4c	3a	3b	3c	2a	2b	2c	1a	1b	1c
Voltage U [V]	400			280			230			180			140		
Current I [A]	3.13	5.06	8.10	2.33	5.50	8.10	2.44	5.10	8.10	2.62	5.83	8.10	2.91	5.44	8.10
Electric input P [W]	1053	2786	4873	838	2383	3467	830	1838	2798	745	1615	2129	648	1142	1541
Speed n [min ⁻¹]	1450	1386	1299	1423	1287	1160	1391	1253	1053	1364	1143	926	1272	994	541
Air-flow rate V [m ³ /h]	0	4125	6768	0	3937	5447	0	3053	4764	0	2852	4200	0	2098	3602
Static pressure Δp _s [Pa]	1003	1009	746	960	865	629	920	783	515	874	647	330	818	472	83
Total pressure Δp _t [Pa]	1003	1058	877	960	909	714	920	810	580	874	670	372	818	485	120

INSTALLATION

- RQ fans (including other Vento elements and equipment) are not intended, due to their concept, for direct sale to end customers. Each installation must be performed in accordance with a professional project created by a qualified air-handling designer who is responsible for the proper selection of fan. The installation and commissioning may be performed only by an authorized company licensed in accordance with generally valid regulations.
- It is recommended to use elastic connections; a DV elastic connection on the discharge side and the DK elastic connection on the intake side.
- It is advisable to always place an air filter in front of the fan to protect it and the duct against dirtying and dust fouling.
- The RQ fans are provided on three sides with anchoring holes to be anchored to the foundations in one of three possible positions ① ② ③ (see fig. #3).

FIGURE 3 – ANCHORING HOLES

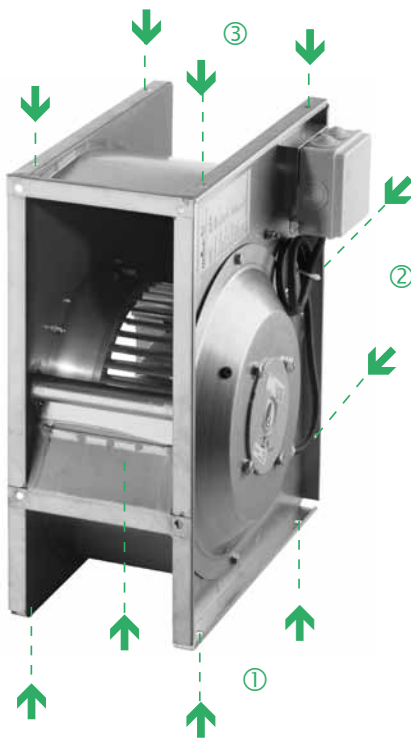

WIRING

- The wiring can be performed only by a qualified worker licensed in accordance with national regulations.
- An all-plastic terminal box fixed with screws to the fan casing, and equipped with WAGO terminals; max. cross-section of connecting conductors 1.5 mm²
- The fans are equipped with thermo-contacts situated in the motor winding; they are connected to the TK terminals. If the motor gets too hot, the thermo-contact will open. The thermo-contact must be connected to the control or regulating system (e.g. control unit, TRN controller or STE relay) which is able to evaluate the failure, and protect the motor against unwanted thermal effects.

FIGURE 4 – WIRING DIAGRAM

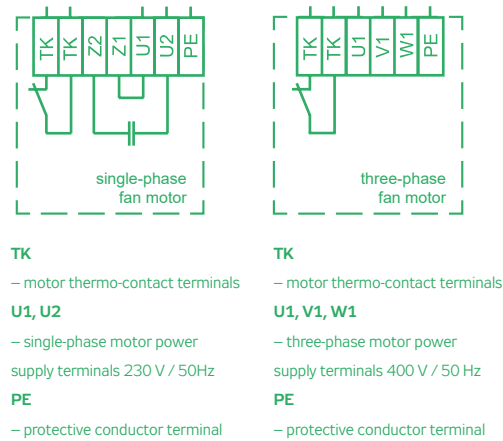

The wiring diagrams with front-end elements (protective relays, controllers, control units) are included in the installation manual, respectively in the AeroCAD project.

On the following pages you will find some basic examples of the fan connection to output controllers and control units. AeroCAD software is available for precise design of the wiring.

EXAMPLE A

RQ FANS WITHOUT OUTPUT CONTROL AND WITH STE PROTECTING RELAY

The RQ fan connection in a simple venting system without output control is shown in figure # 5.

This connection ensures:

- Thermal protection of the fan using thermo-contacts and protecting relay, STE (single-phase) or STD (three-phase).
- Manual switching on/off of the fan using buttons on the STE(D) protecting relay.

After pressing the button marked "I" on the STE(D) protecting relay, the fan starts and the button will stay in the depressed position, signalling the fan's operation. The fan can be stopped by pressing the button marked "O".

If the motor winding is overheated above +130 °C due to overloading, the thermo-contacts in the motor winding will open. Upon the thermo-contacts opening, which are interconnected with the fan terminal box, the STE(D) protecting relay circuit TK, TK will be disconnected. As a reaction to this state, the STE(D) protecting relay will disconnect the power supply to the overheated motor. After cooling down, the motor is not automatically started. The failure must be confirmed (unblocked) by the operator by pressing the black "I" button..

FIGURE 5 – FAN CONNECTION

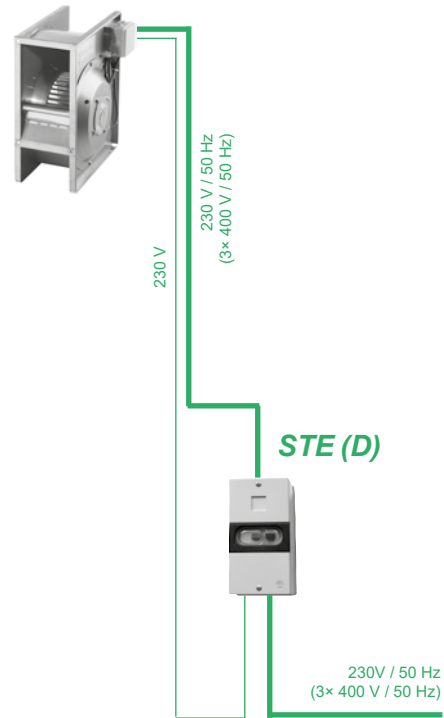

EXAMPLE B

RQ FANS WITH OUTPUT CONTROL AND TRN CONTROL

The RQ fan connection in a simple venting system with one or more fans which must be controlled independently using the TRN controller with ORe 5 controller is shown in figure # 6.

This connection of the speed controller ensures:

- The possibility of fan output selection within the stage range 1-5.
- Thermal protection of the fan
- Fan switching on/off manually by the ORe 5 remote controller.
- Fan switching on/off manually by any other switch (like room thermostat, gas detector, pressostat, hygrosat, etc.) on terminals PT1, PT2.

Upon selecting the required output stage using a selector on the ORe 5 controller, the fan will start at the corresponding speed. The closed switch connected to PT1, PT2 terminals and the thermo-contact circuit connected to TK, TK terminals are essential for the fan operation. The switch connected to PT1, PT2 terminals can externally stop the fan. If this possibility is not used, it will be necessary to interconnect terminals PT1 and PT2. If the fan is overloaded, the thermo-contact circuit will be disconnected due to overheating of the motor winding. As a reaction to this state, the controller will disconnect the fan power supply, and the red control light on the ORe5 controller will signal the failure. After cooling down, the motor is not automatically started. To restart the fan, it is necessary first to set the selector to the "STOP" position, and thus confirm failure removal, and then to set the required fan output. In this arrangement, the option "STOP" must not be blocked.

FIGURE 6 – FAN CONNECTION

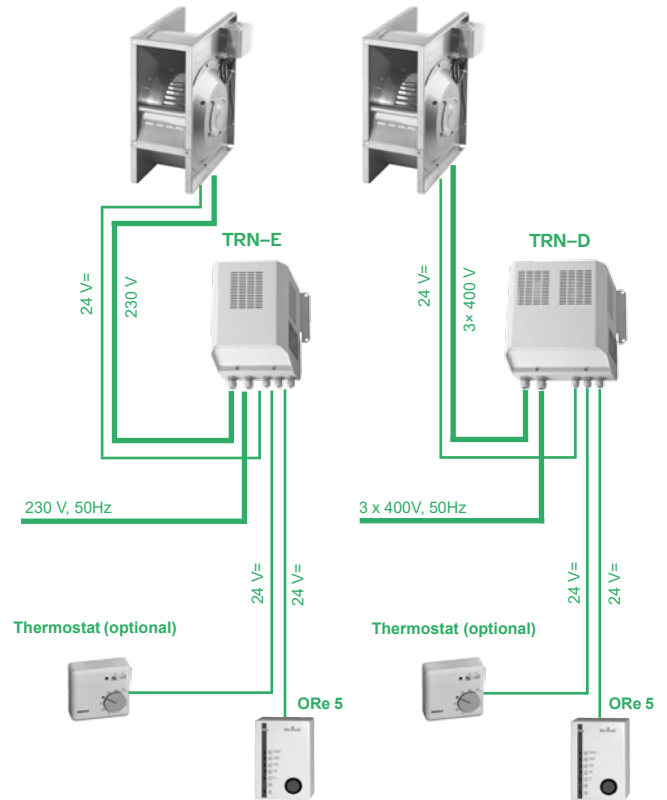

RP
RQ
RO
RE
RF
RPH
EX
TR..
EO..
VO
SUMX
CHV
CHF
HRV
HRZ
PRI

EXAMPLE C
RQ FANS WITHOUT OUTPUT CONTROL AND WITH CONTROL UNIT

The RQ fan without output control connection in more sophisticated venting systems using the control unit is shown in figure # 7. Among others, this connection ensures:

- The motor protection (TK thermo-contact terminals are connected to 5a, 5a, 5b, 5b terminals in the control unit).
- Manual or programmable switching on/off of the entire device using a control unit.

The air-handling system is started by the control unit. All protecting and safety functions of fans as well as the entire system are ensured by the control unit.

FIGURE 7 – FAN CONNECTION

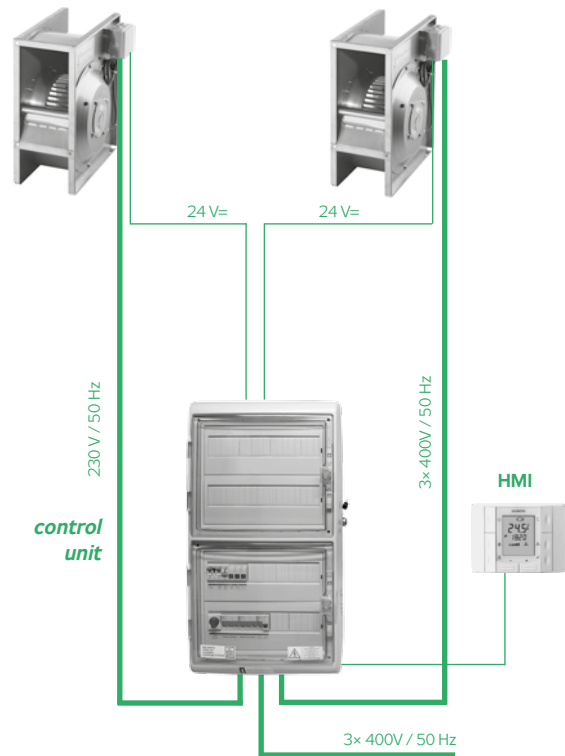
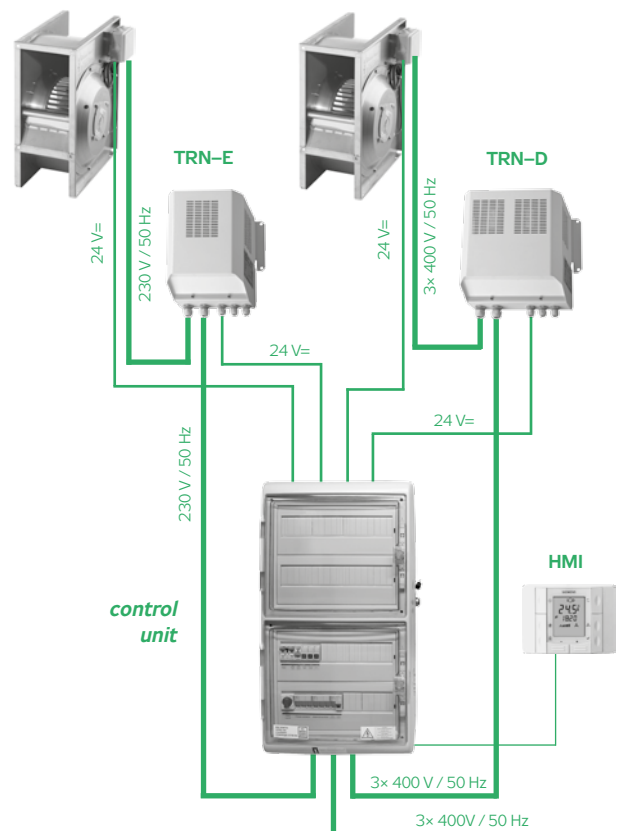

FIGURE 8 – FAN CONNECTION



EXAMPLE D
RQ FANS WITH TRN CONTROLLERS AND CONTROL UNIT

Connection of RQ fans equipped with an output control with two TRN controllers and an independent internal control for each controller is shown in figure # 8. The internal control is installed in the control unit during production. Among others, this connection ensures:

- Manual selection of the fan output within the stage range 1-5 via HMI controller and/or using time schedule function of control unit, separate or independently for the inlet and outlet (this can be used to get the required overpressure or underpressure in the room).
- Thermal protection of the motor (connecting the TK, TK thermo-contact terminals to 5a, 5a, 5b, 5b terminals in the control unit).
- Manual or programmable switching on/off of the entire device using a control unit.

In this connection, all additional functions of the controller must always be blocked by interconnecting the PT2 and E48 terminals in the TRN controller.

The air-handling system is started by the control unit. Other properties are influenced by the setting options of connected components (controllers, controls). All protecting and safety functions of fans as well as the entire system are ensured by the control unit.

RP

RQ

RO

RE

RF

RPH

EX

TR..

EO..

VO

SUMX

CHV

CHF

HRV

HRZ

PRI