



RP
RQ
RO
RE
RF
RPH
EX
TR.
EO..
VO
SUMX
CHV
CHF
HRV
HRZ
PRI

APPLICATIONS OF WATER HEATERS

Hot-water heaters are intended for air heating, from simple venting installations to sophisticated air-handling systems. They are designed to be installed directly in square air ducts. Ideally, they can be used along with other components of the Vento modular system which ensure inter-compatibility and balanced parameters.

OPERATING CONDITIONS

The heated air must be free of solid, fibrous, sticky and aggressive impurities. The heated air must also be free of corrosive chemicals or chemicals aggressive to aluminium, copper and/or zinc. Maximum allowed operating parameters of heating water:

- Max. allowed water temperature **+130 °C**
- Max. allowed water pressure **1,6 MPa**

Performance properties of water heaters for common values of water temperature gradients, various air flow rates and inlet air temperatures for water as a heat-transfer agent are included in nomograms in the data section of this catalogue.

DIMENSIONAL RANGE

VO water heaters are manufactured in a range of ten sizes according to the A x B dimensions of the connecting flange (see figure # 1). Single, two and three-row heaters are available for all sizes (except for sizes 30-15 and 40-20 - only two and three-row heaters). Water heaters can be connected to air ducts in the same way as any other Vento duct system component. Connections of all water heaters to the heating water supply are maximally standardized. These heaters enable designers to cover the full air flow range of Vento fans.

POSITION AND LOCATION

When projecting the layout of the heater location, we recommend observing the following principles:

- If water is used as the heating medium, the heater can be situated only in an indoor environment where the temperature is maintained above freezing point (this does not apply to heated air during operation).
- Outdoor installation is allowed only if an antifreeze solution is used as the heating medium (mostly ethylene glycol solution). In this case, the actual heater's parameters must be calculated using AeroCAD software.
- Water heaters can work in any position in which air venting of the heater is possible.
- Free access to the heater must be ensured to enable control and service.
- An air filter must be installed in front of the heater to avoid its fouling.
- The counter-current connection of the heater is needed to achieve maximum output.
- The heater can be situated either in front of or behind the fan. However, if the heater is in front of the fan, the heater output must be controlled so that the air temperature will not exceed the maximum allowed value for the given fan..

- If the heater is situated behind the fan, we recommend inserting between the fan and the heater a spacer (e.g. 1-1.5 m long straight duct) to steady the air flow.

MATERIALS AND DESIGN

The external casing of the heaters is made of galvanized steel sheets. The headers are made of welded steel pipes and finished with a synthetic coating. The heat exchange surface is created by 0.1 mm thick aluminium overlapping fins pulled on copper pipes of $\varnothing 9.52$ mm (3/8"). As standard, VO heaters are manufactured in two-row versions with shifted geometry (ST 25 x 22 mm). All used materials are carefully checked so they ensure long service life and reliability. All heaters are tested under water for leakage using pressurised air of 3–3,6 MPa.

FIGURE 2 - HEATER'S DESIGN

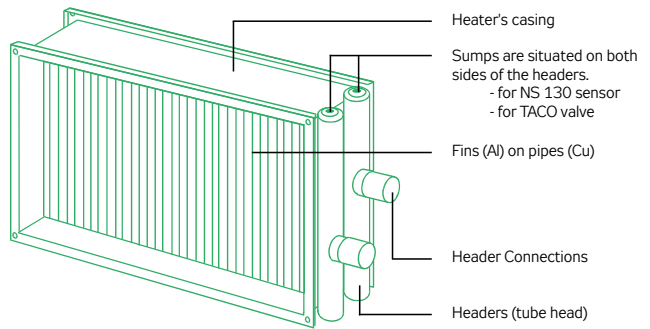

DESIGNATION OF HEATERS

The type designation of heaters in projects and orders is defined by the key in figure # 3. The heater's output is only valid for the selected operating conditions. Selected (i.e. nominal) operating conditions are specified by the air flow rate at air flow velocity of 3.7 m/s, inlet air temperature of -15 °C and heating water operating temperature gradient of +90 °C / +70 °C. Nominal operating conditions are included in the nomograms (according to the number) as an example. Accessories like self-air venting TACO valve, SUMX mixing set and NS 130R anti-freeze sensor featuring short time constant (resp. other sensors) can be delivered. Accessories are not included in the heater delivery so must be ordered separately.

FIGURE 3 - DESIGNATION OF HEATERS

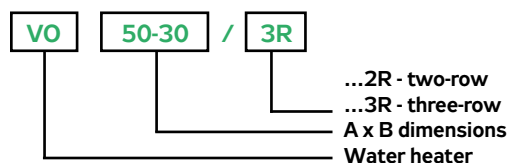

AIR-VENTING OF THE HEATER

Pro zabezpečení správné funkce ohřivače je nutno zajistit jeho spolehlivé odvzdušnění, nejlépe automatické. Automatický odvzdušňovací ventil TACO s vnějším závitem G 1/2" je určen pro zašroubování přímo do sběračů ohřivače. Instaluje se v nejvyšším místě obou sběračů. Díky malým rozměrům je ventil vhodný zejména pro instalaci ohřivače těsně pod strop místnosti.

ANTIFREEZE PROTECTION

Antifreeze protection of the heater is created by comprehensive interconnected equipment preventing freezing of the heater in normal operating conditions. To ensure safety of the assembly, it is advisable to use proven Vento components, the choice of which depends on the particular device and the selected control unit. As standard, the antifreeze protection consists of:

- řídící jednotky
- Control unit
- NS 130R water temperature sensors, NS 120 air temperature sensors and optionally a capillary probe
- Inlet air damper controlled by the safety actuator
- Mixing Set

A particular configuration of the antifreeze protection can be specified using the catalogue of control units, respectively using AeroCAD software, available from REMAK or their distributors.

DIMENSIONS AND WEIGHTS

For important dimensions and weights (without water filling) of heaters, refer to figure # 5 and table # 1.

The connection for the heating water is provided with G 1" outer thread which is used for all heater sizes. Connections for TACO valves and NS 130 sensor are provided with G1/2" inner thread.

TABLE 1 - DIMENSIONS OF WATER HEATERS

Heater	A	B	C	D	E	F	G	m (2R) ±10 %
	mm	mm	mm	mm	mm	mm	mm	kg
VO 30-15	300	150	320	170	340	190	130	4,1
VO 40-20	400	200	420	220	440	240	180	5,6
VO 50-25	500	250	520	270	540	290	230	6,6
VO 50-30	500	300	520	320	540	340	280	7,1
VO 60-30	600	300	620	320	640	340	280	8,1
VO 60-35	600	350	620	370	640	390	330	8,8
VO 70-40	700	400	720	420	740	440	380	10,6
VO 80-50	800	500	820	520	840	540	480	13,5
VO 90-50	900	500	930	530	960	560	480	15,2
VO 100-50	1000	500	1030	530	1060	560	480	17,7

FIGURE 4 - HEATER WITH A MIXING SET

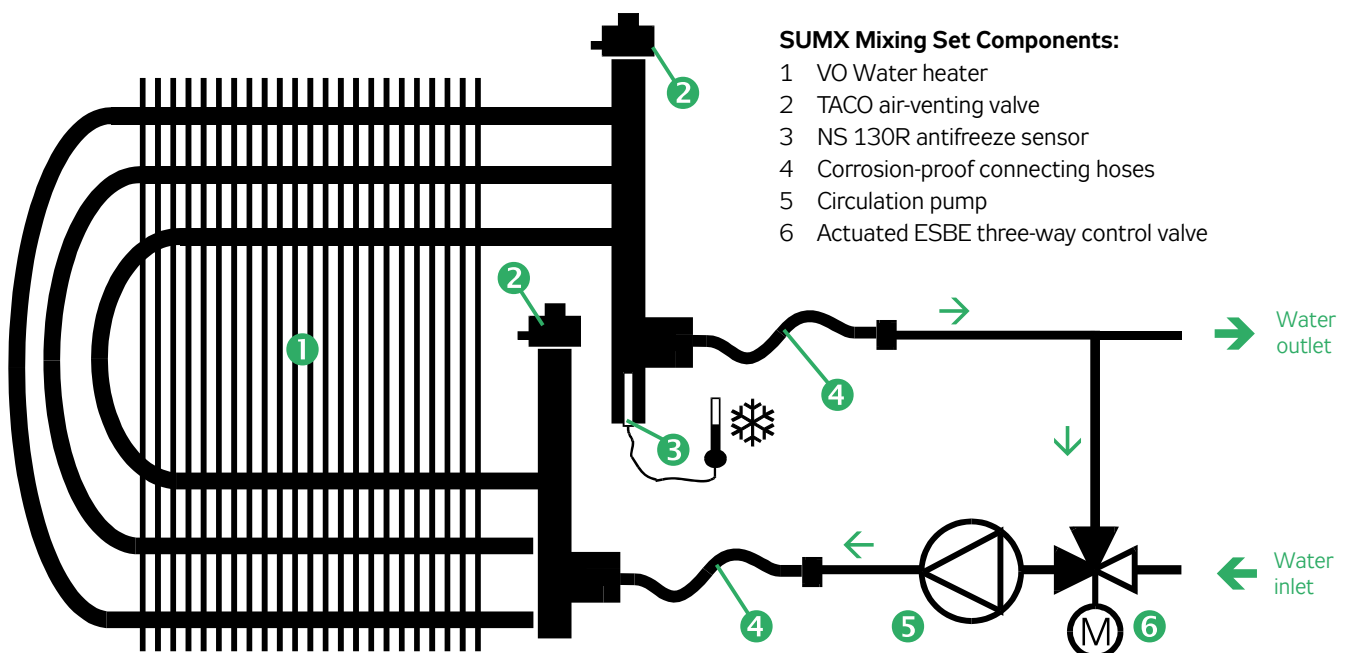
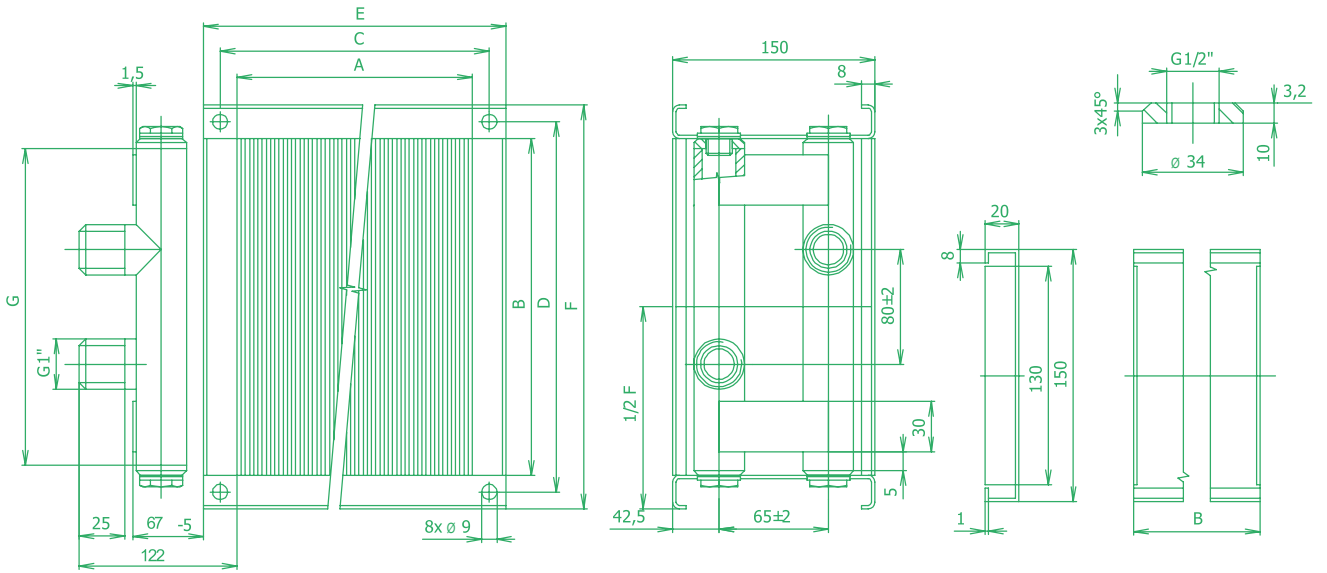
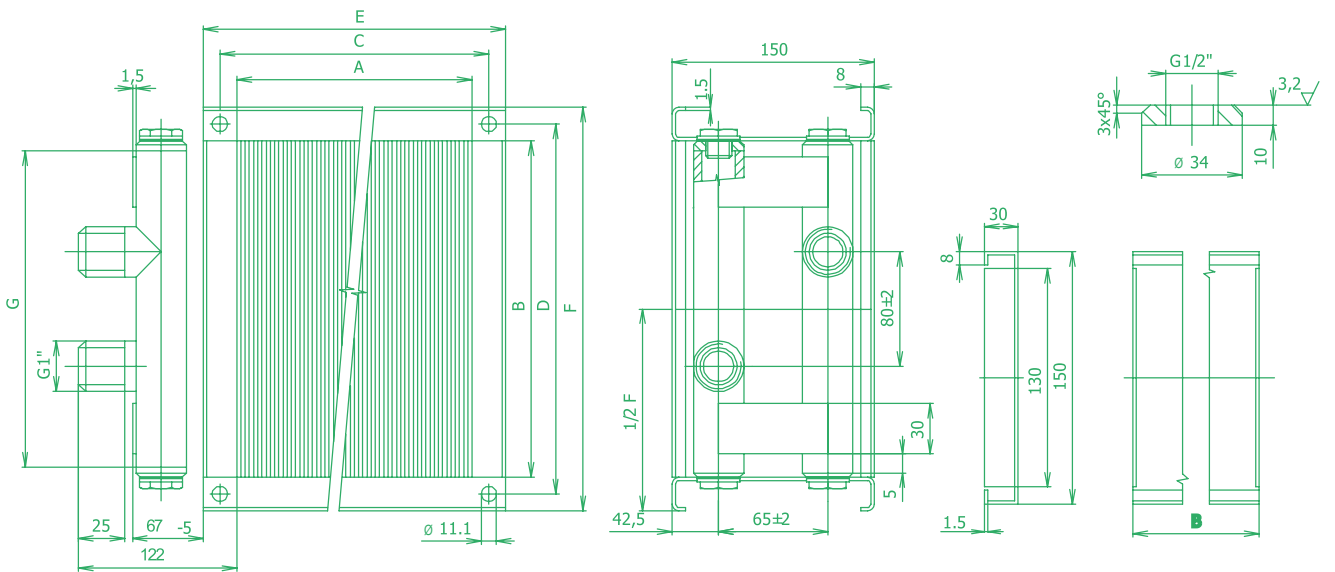

FIGURE 5 - DIMENSIONS OF VO WATER HEATERS (TYPE DESIGNATION CORRESPONDS WITH TABLE # 1)

Dimensional range 30-15 to 80-50



Dimensional range 90-50 to 100-50



HEATER DIMENSIONING

For nomograms showing the thermodynamic correlation for each heater, refer to pages 198-214. All necessary final parameters of the heater corresponding to the performance job can be obtained from the nomograms:

Required default parameters

- Selected heater's size
- Air flow rate (velocity in the cross-section)
- Calculated inlet air temperature
- Calculated water temperature gradient

Determined final parameters:

- Outlet air temperature
- Heater's output
- Required water discharge
- Water pressure loss
- Air pressure loss³⁾

Heater Dimensioning Procedure

- Outlet air temperature behind the heater ④ for required default parameters ① ② ③ can be determined from the nomograms.
- If the outlet air temperature ④ is the same or higher than the required temperature, the heater complies with the performance job.
- Maximum output of the heater ⑦, maximum water discharge ⑨ and water pressure loss ⑩ at maximum discharge for the required default parameters ① ⑤ ⑥ can also be determined from the nomograms.⁴⁾
- A suitable mixing set for water discharge and pressure loss at the given discharge can be determined following the procedure included in the section SUMX Mixing Sets.
- The heater's pressure loss at the given air flow rate for calculation of the assembly pressure loss balance needed for the fan selection can be obtained from the nomogram on page 215.

³⁾ The air pressure loss for all heaters can be determined from the nomogram. As the design of the heaters is standardized, the pressure loss only depends on the air flow velocity through the heater. The nomogram also includes air flow rate - velocity conversion curves for all heater sizes.

⁴⁾ The nomograms cannot be used to determine the maximum calculated output and water discharge because value $\Delta t_w = 20K$ is given for the fixed heating water temperature gradients.

VO 30-15/2R (Cu/Al vodní ohřivač 300 x 150 mm)

Nomogram of thermodynamic characteristics

Air flow rate - Inlet air temperature - Water temperature gradient
 Outlet air temperature - Output - Water discharge and pressure loss

t_2 - Outlet air temperature behind the heater (°C) →
 5 15 25 31,2 35 45 55 65 75

V - air flow rate (m³/h) →

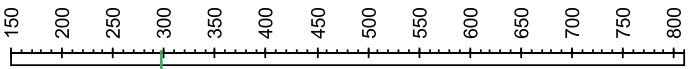

v - Air flow velocity in the heater (m/s) →

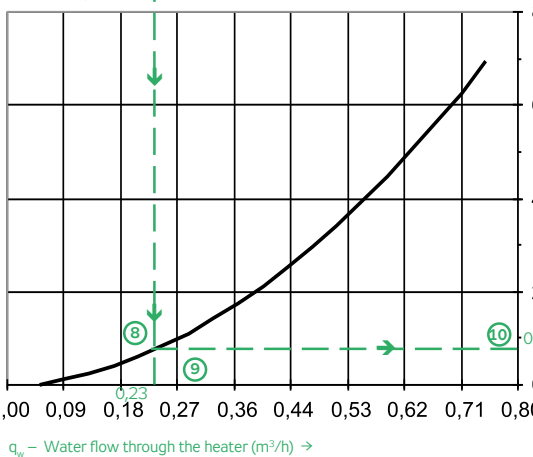
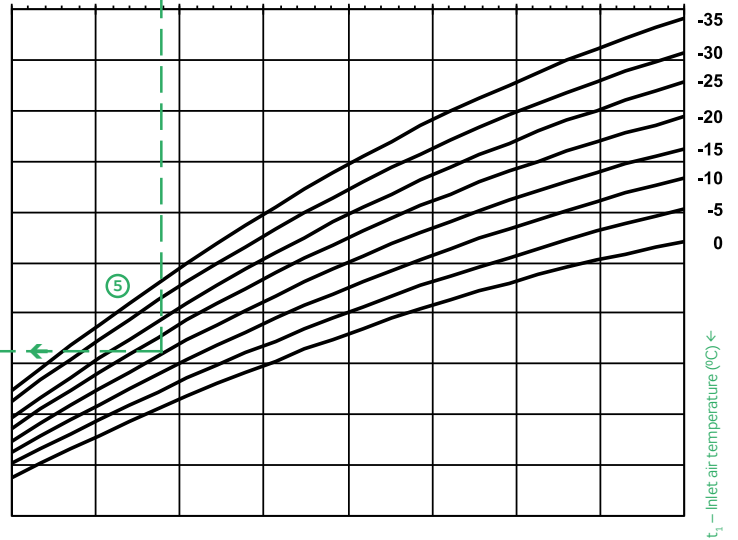
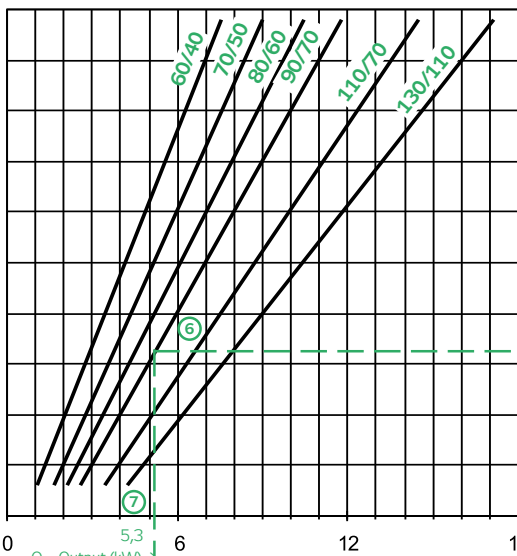
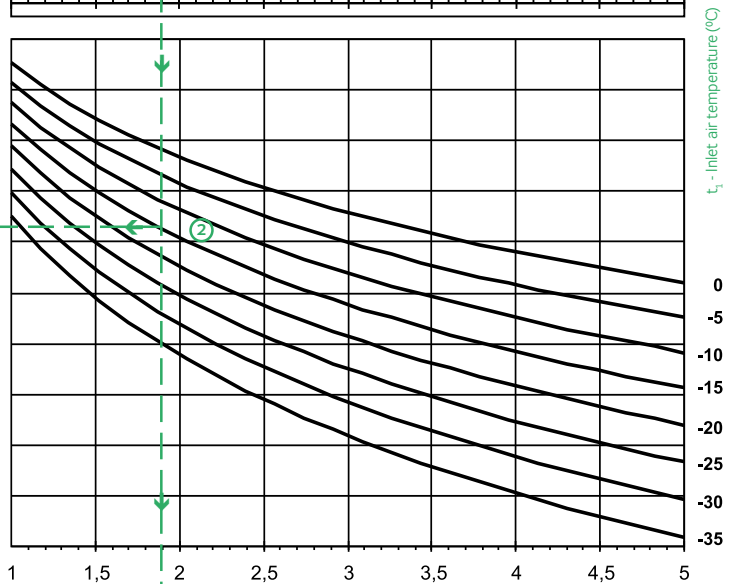
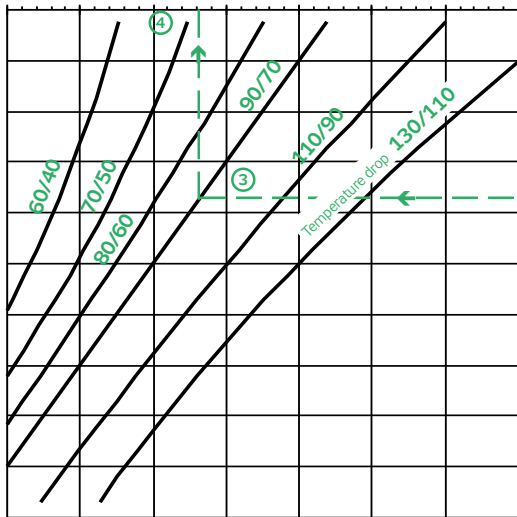
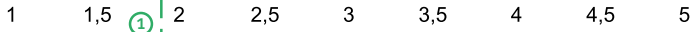

Δp_w - Water pressure loss at water side (kPa) →

Example:

At the selected air flow rate of 300 m³/h ①, the velocity of the air flow through the 30-15/2R heater will be 1.85 m/s. For the selected air flow rate (speed) at inlet air temperature in front of the heater of -15 °C ②, and heating water temperature gradient of +90/+70 °C ③, the outlet air temperature behind the heater will be +31.2 °C ④. Heater output of 5.3 kW ⑦ comports with the selected air flow rate (speed) ① at the inlet air temperature in front of the heater ⑤ and the same water temperature gradient ⑥; while the required water discharge ⑨ will be 0.23 m³/h at water pressure loss ⑩ in a heater of 0.8 kPa.

Values in the nomogram can be interpolated and extrapolated.

VO 40-20/2R (Cu/Al vodní ohřivač 400 x 200 mm)

Nomogram of thermodynamic characteristics

Air flow rate - Inlet air temperature - Water temperature gradient

Outlet air temperature - Output - Water discharge and pressure loss

V – air flow rate (m³/h) →

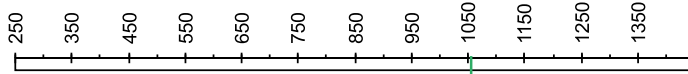

v – Air flow velocity in the heater (m/s) →

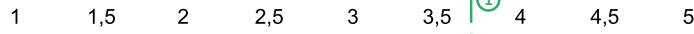

t₂ – Outlet air temperature behind the heater (°C) →

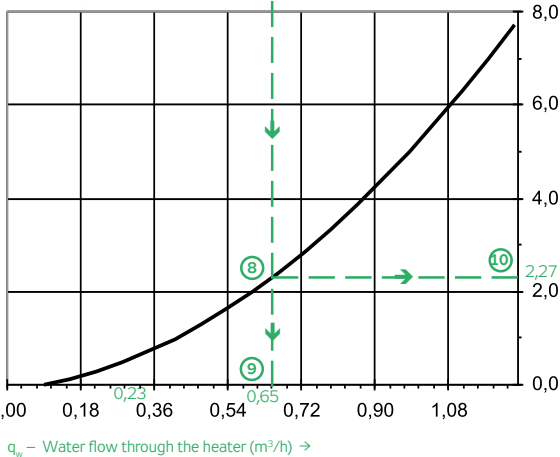
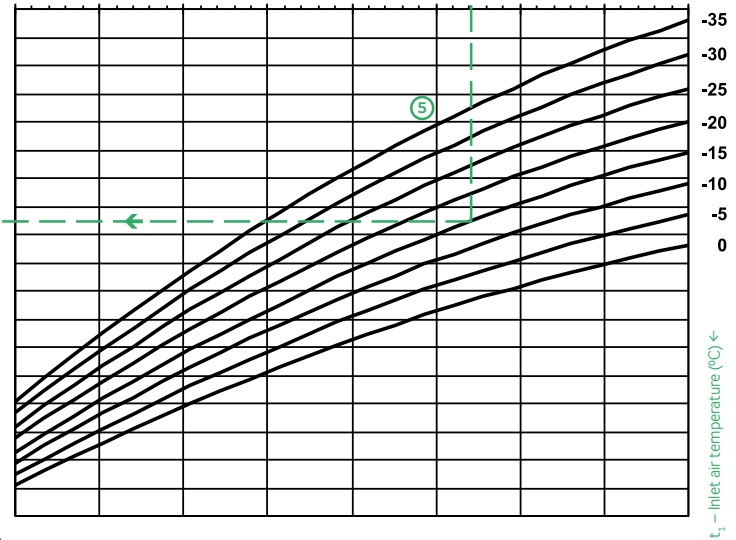
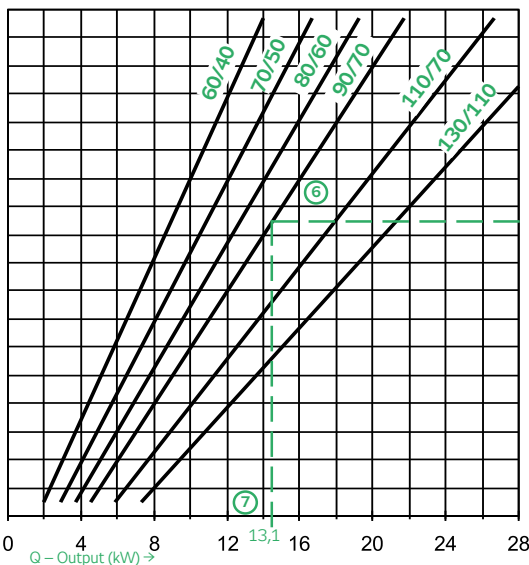
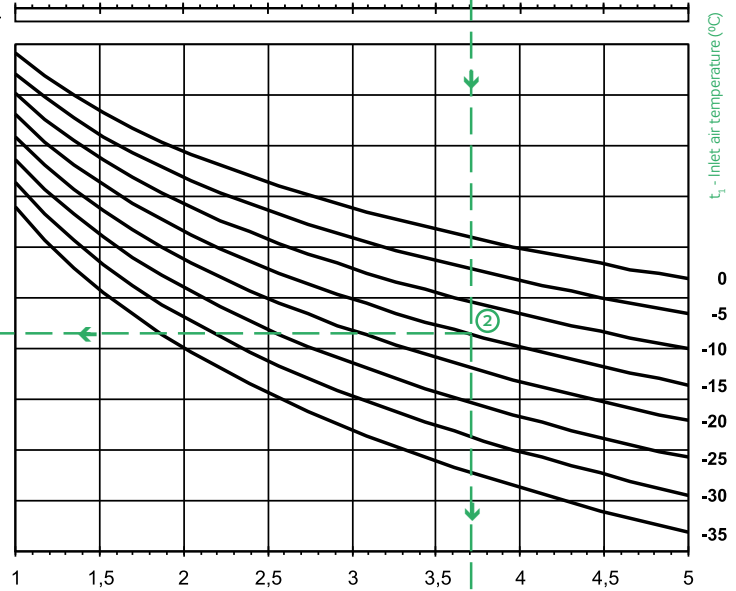
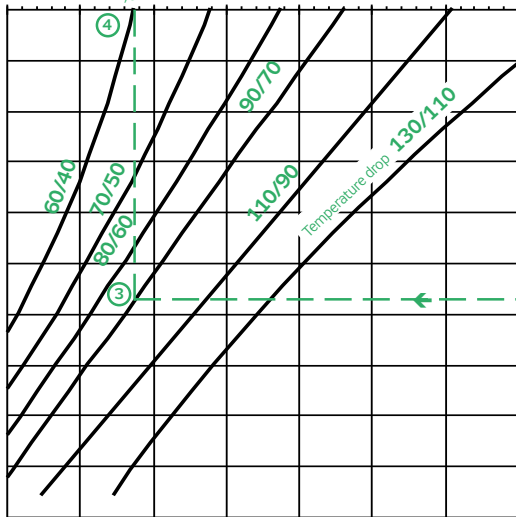

Example:

At the selected air flow rate of 1066 m³/h ①, the velocity of the air flow through the VO 40-20/2R heater will be 3,7 m/s.

For the selected air flow rate (speed) at inlet air temperature in front of the heater of -15 °C ②, and heating water temperature gradient of +90/+70 °C ③, the outlet air temperature behind the heater will be +21,6 °C ④.

Heater output of 13,1 kW ⑦ comports with the selected air flow rate (speed) ① at the inlet air temperature in front of the heater ⑤ and the same water temperature gradient ⑥; while the required water discharge ⑨ will be 0,65 m³/h at water pressure loss ⑩ in a heater of 2,27 kPa.

Values in the nomogram can be interpolated and extrapolated.

- RP
- RQ
- RO
- RE
- RF
- RPH
- EX
- TR..
- EO..
- VO
- SUMX
- CHV
- CHF
- HRV
- HRZ
- PRI

VO 50-25/2R (Cu/Al vodní ohřivač 500 x 250 mm)

Nomogram of thermodynamic characteristics

Air flow rate - Inlet air temperature - Water temperature gradient
 Outlet air temperature - Output - Water discharge and pressure loss

t_2 - Outlet air temperature behind the heater (°C) →
 5 15 25 35 45 55 65 75

V - air flow rate (m³/h) →
 450 550 650 750 850 950 1050 1150 1250 1350 1450 1550 1650 1750 1850 1950 2050 2150 2250

v - Air flow velocity in the heater (m/s) →
 1 1,5 2 2,5 3 3,5 ① 4 4,5 5

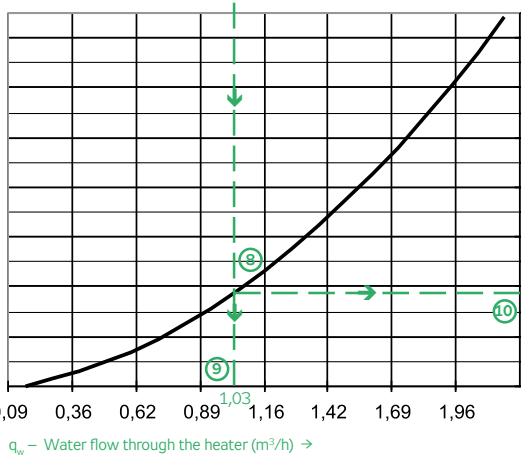
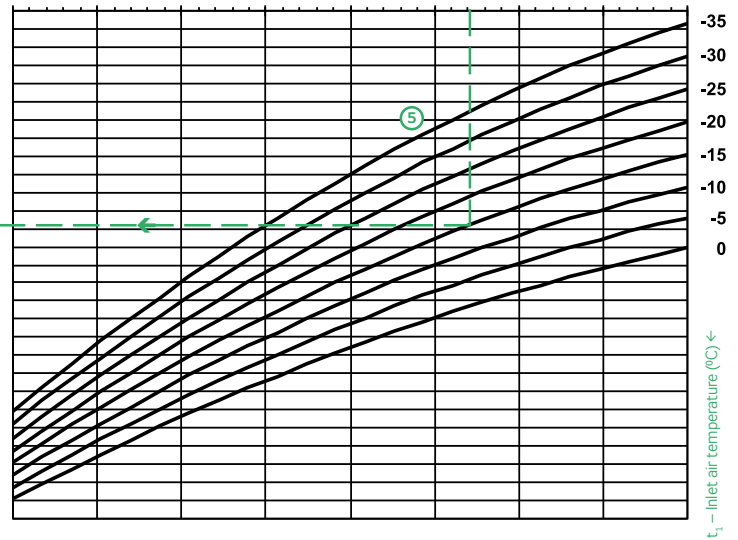
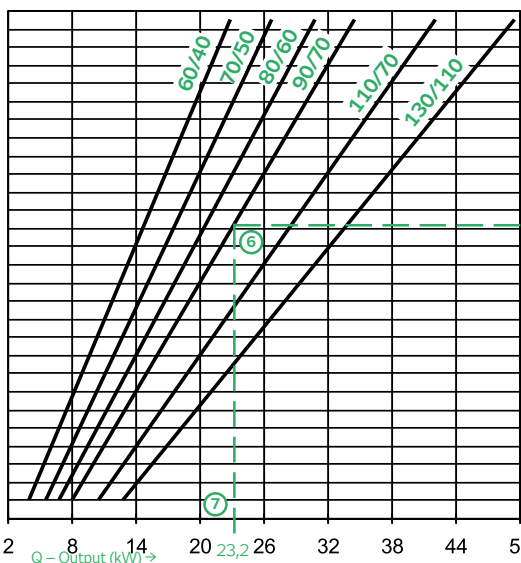
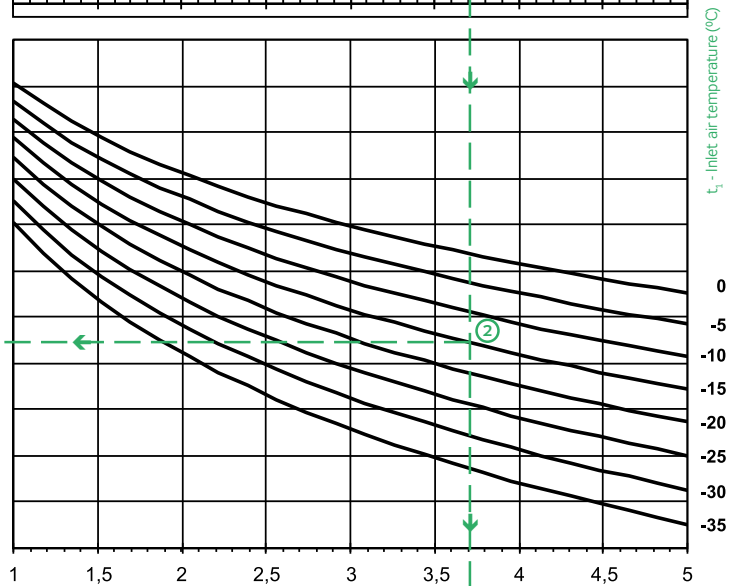
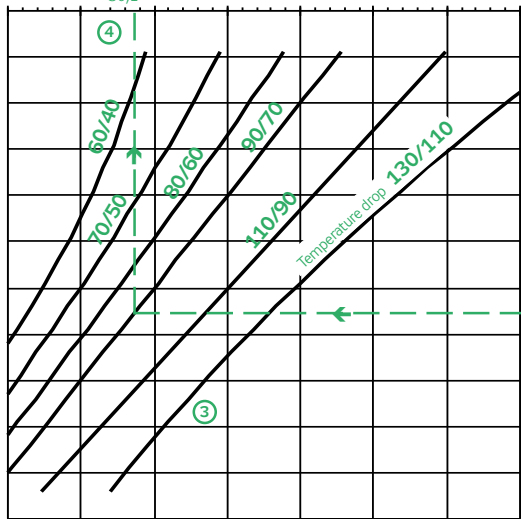

Example:
 At the selected air flow rate of 1665 m³/h ①, the velocity of the air flow through the VO 50-25/2R heater will be 3,7 m/s.
 For the selected air flow rate (speed) at inlet air temperature in front of the heater of -15 °C ②, and heating water temperature gradient of +90/+70 °C ③, the outlet air temperature behind the heater will be +22,3 °C ④.
 Heater output of 23,2 kW ⑦ comports with the selected air flow rate (speed) ① at the inlet air temperature in front of the heater ⑤ and the same water temperature gradient ⑥; while the required water discharge ⑨ will be 1,03 m³/h at water pressure loss ⑩ in a heater of 3,76 kPa.

Values in the nomogram can be interpolated and extrapolated.

VO 50-30/2R (Cu/Al vodní ohřivač 500 x 300 mm)

Nomogram of thermodynamic characteristics

Air flow rate - Inlet air temperature - Water temperature gradient

Outlet air temperature - Output - Water discharge and pressure loss

t_2 - Outlet air temperature behind the heater (°C) →

V - air flow rate (m³/h) →

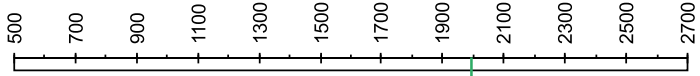

v - Air flow velocity in the heater (m/s) →

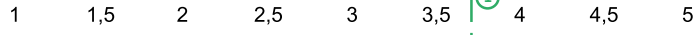

5 15 25 35 45 55 65 75

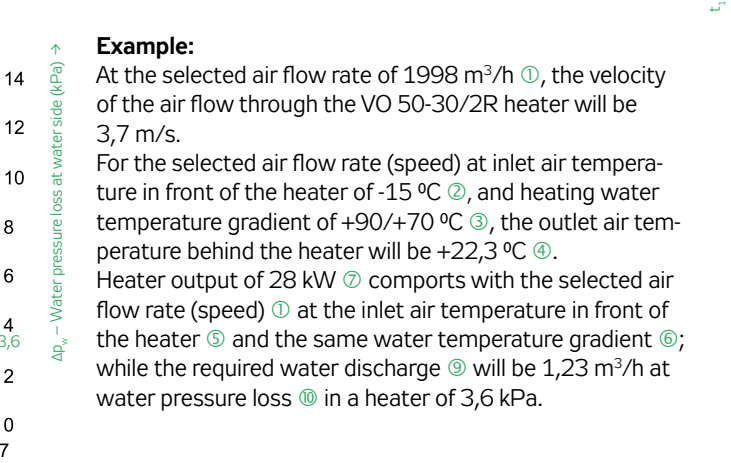
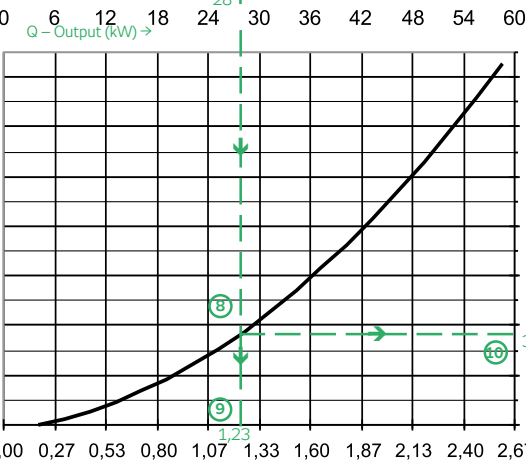
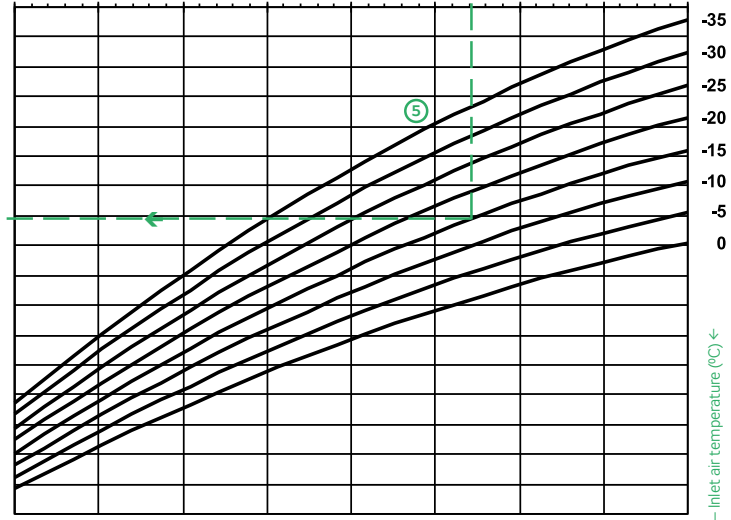
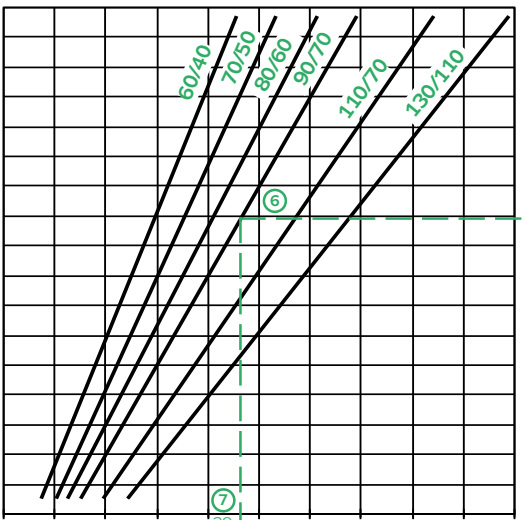
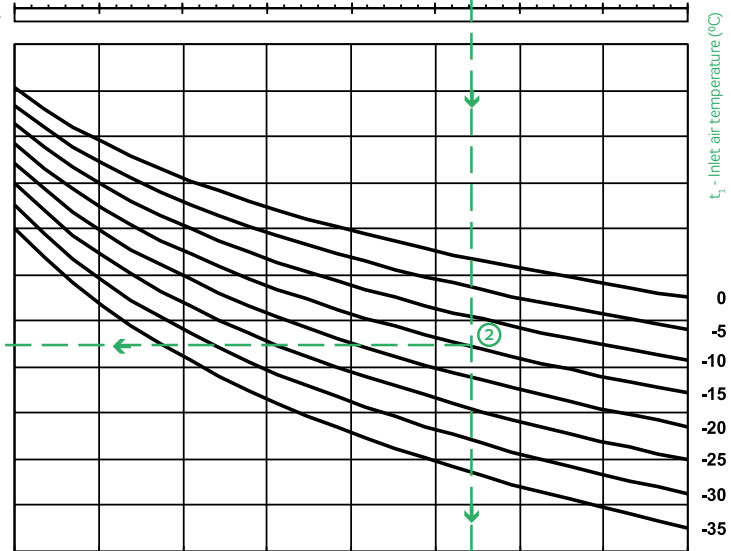
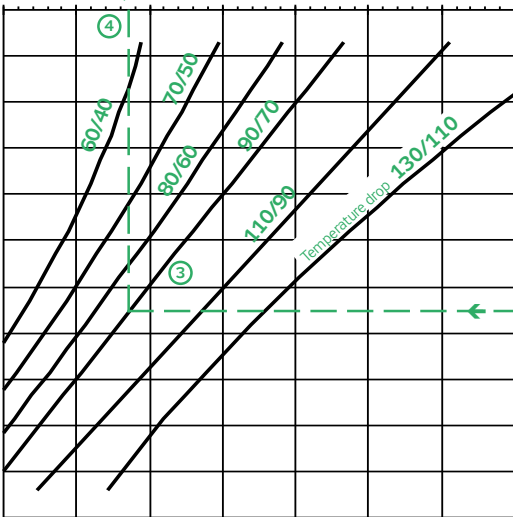

Example:

At the selected air flow rate of 1998 m³/h ①, the velocity of the air flow through the VO 50-30/2R heater will be 3,7 m/s.
 For the selected air flow rate (speed) at inlet air temperature in front of the heater of -15 °C ②, and heating water temperature gradient of +90/+70 °C ③, the outlet air temperature behind the heater will be +22,3 °C ④.
 Heater output of 28 kW ⑦ comports with the selected air flow rate (speed) ① at the inlet air temperature in front of the heater ⑤ and the same water temperature gradient ⑥; while the required water discharge ⑨ will be 1,23 m³/h at water pressure loss ⑩ in a heater of 3,6 kPa.

Values in the nomogram can be interpolated and extrapolated.

q_w - Water flow through the heater (m³/h) →

①

②

③

④

⑤

⑥

⑦

⑧

⑨

⑩

RP

RQ

RO

RE

RF

RPH

EX

TR..

EO..

VO

SUMX

CHV

CHF

HRV

HRZ

PRI

VO 60-30/2R (Cu/Al vodní ohřivač 600 x 300 mm)

Nomogram of thermodynamic characteristics

Air flow rate - Inlet air temperature - Water temperature gradient
 Outlet air temperature - Output - Water discharge and pressure loss

t_2 - Outlet air temperature behind the heater (°C) →
 5 15 23 25 35 45 55 65 75

V - air flow rate (m³/h) →
 650 850 1050 1250 1450 1650 1850 2050 2250 2450 2650 2850 3050 3250

v - Air flow velocity in the heater (m/s) →
 1 1,5 2 2,5 3 3,5 ① 4 4,5 5

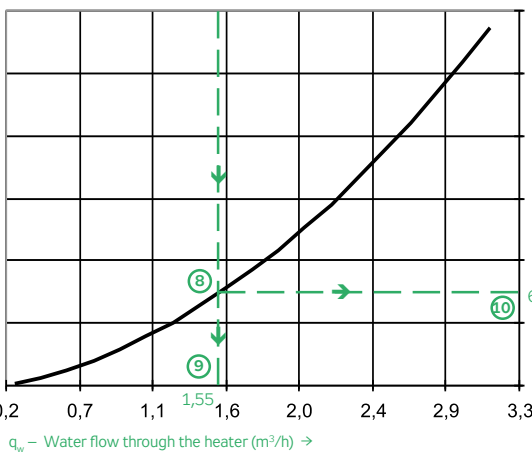
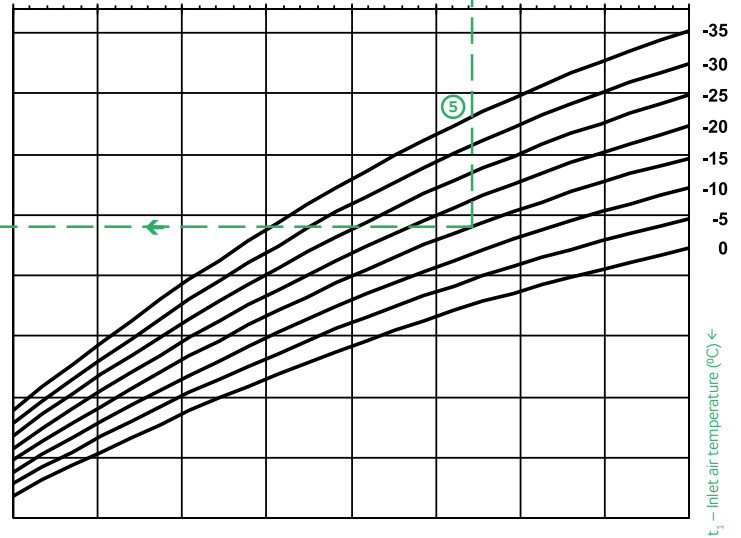
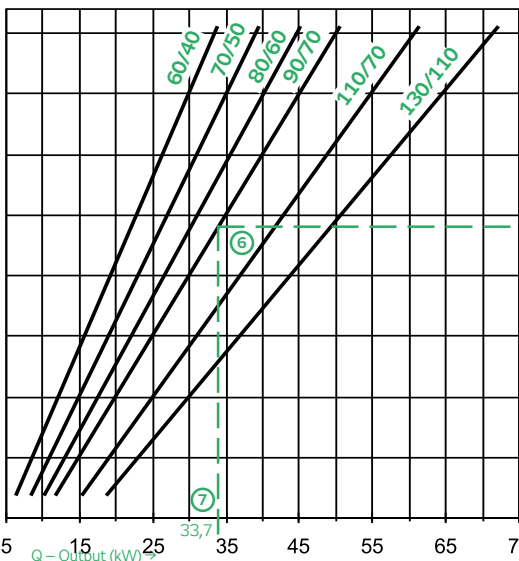
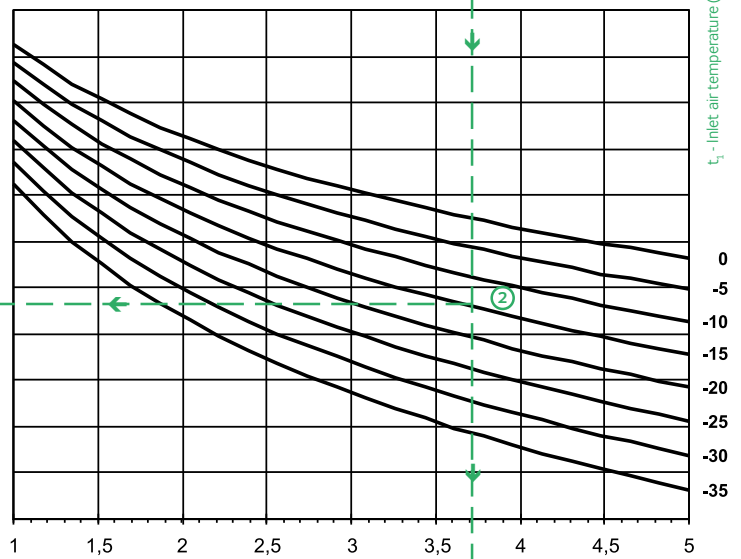
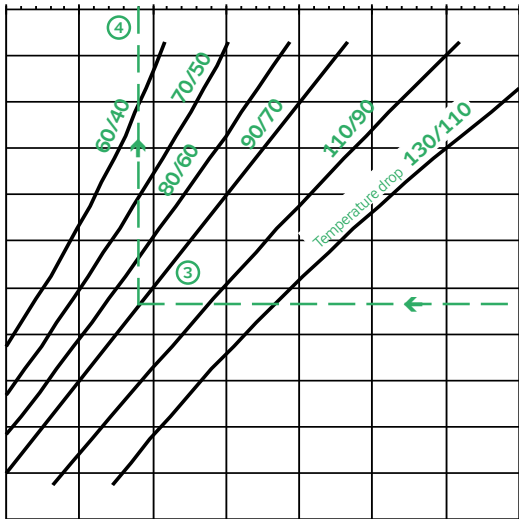

Example:
 At the selected air flow rate of 2398 m³/h ①, the velocity of the air flow through the VO 60-30 / 2R heater will be 3,7 m/s.
 For the selected air flow rate (speed) at inlet air temperature in front of the heater of -15 °C ②, and heating water temperature gradient of +90/+70 °C ③, the outlet air temperature behind the heater will be +23 °C ④.
 Heater output of 33,7 kW ⑦ comports with the selected air flow rate (speed) ① at the inlet air temperature in front of the heater ⑤ and the same water temperature gradient ⑥; while the required water discharge ⑨ will be 1,55 m³/h at water pressure loss ⑩ in a heater of 6,1 kPa.

Values in the nomogram can be interpolated and extrapolated.

VO 60-35/2R (Cu/Al vodní ohřivač 600 x 350 mm)

Nomogram of thermodynamic characteristics

Air flow rate - Inlet air temperature - Water temperature gradient

Outlet air temperature - Output - Water discharge and pressure loss

t_2 – Outlet air temperature behind the heater (°C) →

V – air flow rate (m³/h) →

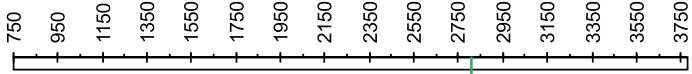

v – Air flow velocity in the heater (m/s) →

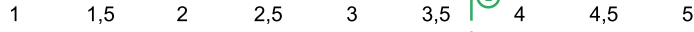

5 15 25 22,9 35 45 55 65 75

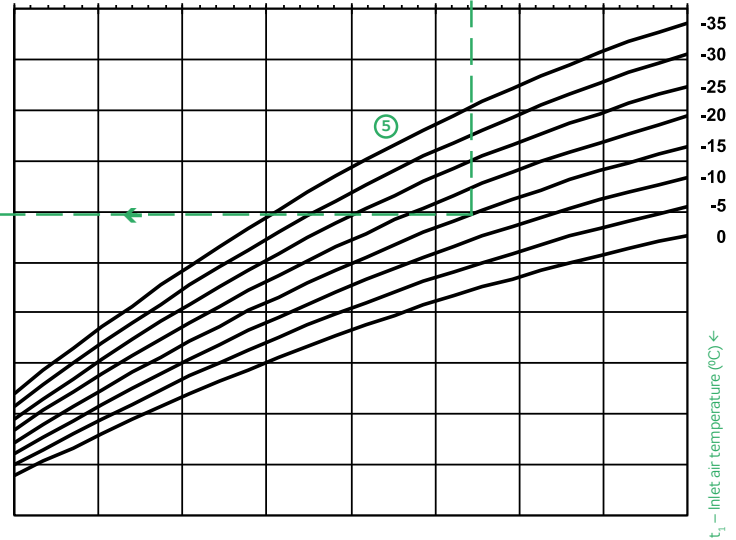
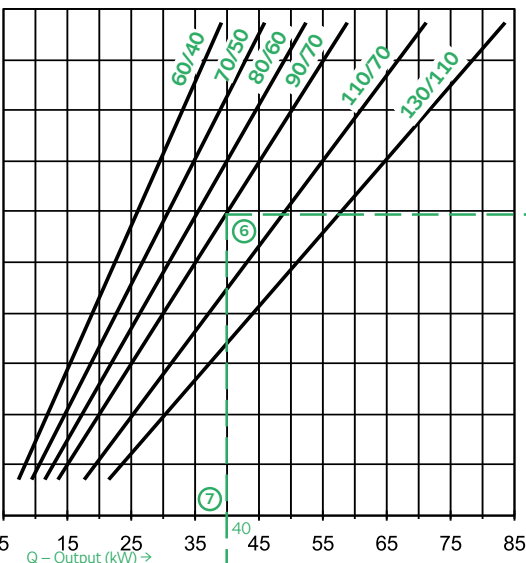
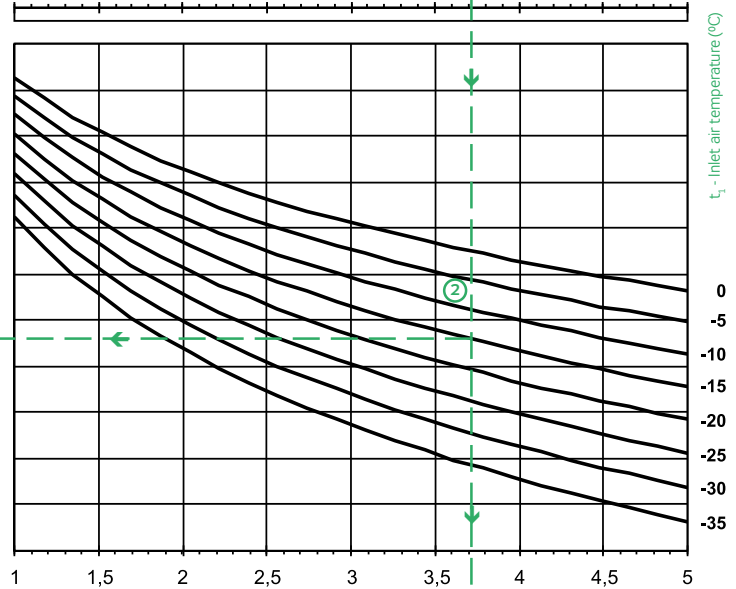
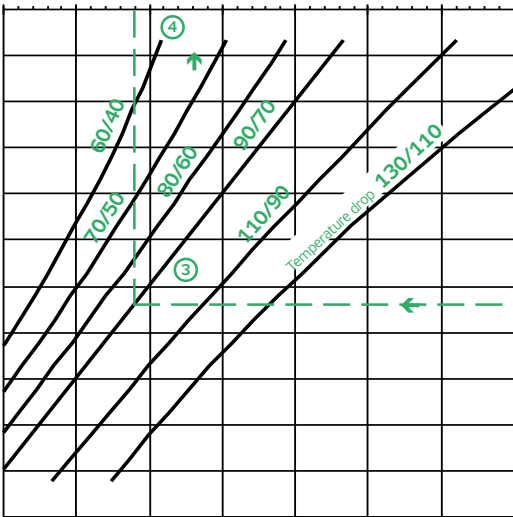

5 15 25 35 40 45 55 65 75 85

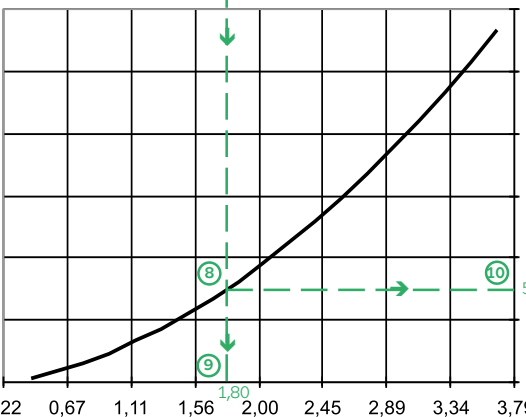

ΔP_w – Water pressure loss at water side (kPa) →

Example:

At the selected air flow rate of 2797 m³/h ①, the velocity of the air flow through the VO 60-35/2R heater will be 3,7 m/s.

For the selected air flow rate (speed) at inlet air temperature in front of the heater of -15 °C ②, and heating water temperature gradient of +90/+70 °C ③, the outlet air temperature behind the heater will be +22,9 °C ⑦.

Heater output of 40 kW ⑦ comports with the selected air flow rate (speed) ① at the inlet air temperature in front of the heater ⑤ and the same water temperature gradient ⑥; while the required water discharge ⑨ will be 1,80 m³/h at water pressure loss ⑩ in a heater of 5,9 kPa.

q_w – Water flow through the heater (m³/h) →

Values in the nomogram can be interpolated and extrapolated.

- RP
- RQ
- RO
- RE
- RF
- RPH
- EX
- TR..
- EO..
- VO**
- SUMX
- CHV
- CHF
- HRV
- HRZ
- PRI

VO 70-40/2R (Cu/Al vodní ohřivač 700 x 400 mm)

Nomogram of thermodynamic characteristics

Air flow rate - Inlet air temperature - Water temperature gradient
 Outlet air temperature - Output - Water discharge and pressure loss

t_2 - Outlet air temperature behind the heater (°C) →
 5 15 25 35 45 55 65 75

V - air flow rate (m³/h) →
 1000 1500 2000 2500 3000 3500 4000 4500 5000

v - Air flow velocity in the heater (m/s) →
 1 1,5 2 2,5 3 3,5 ① 4 4,5 5

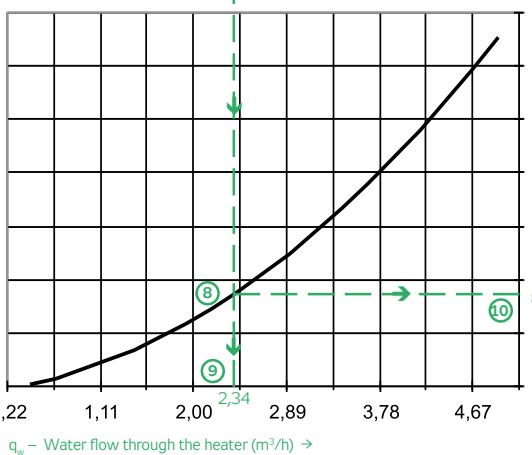
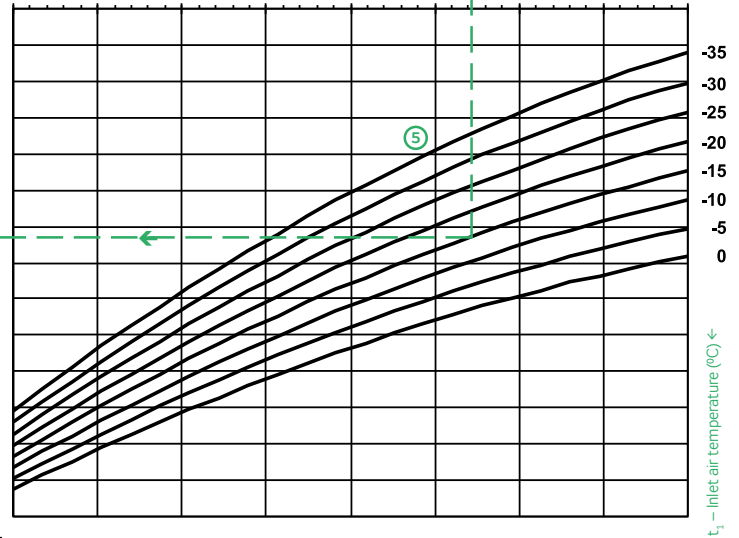
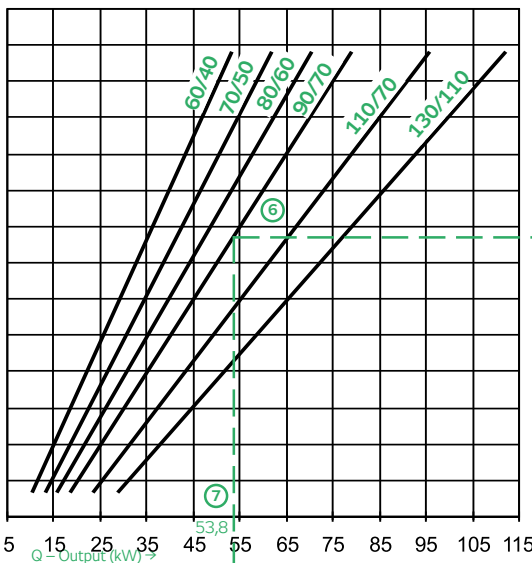
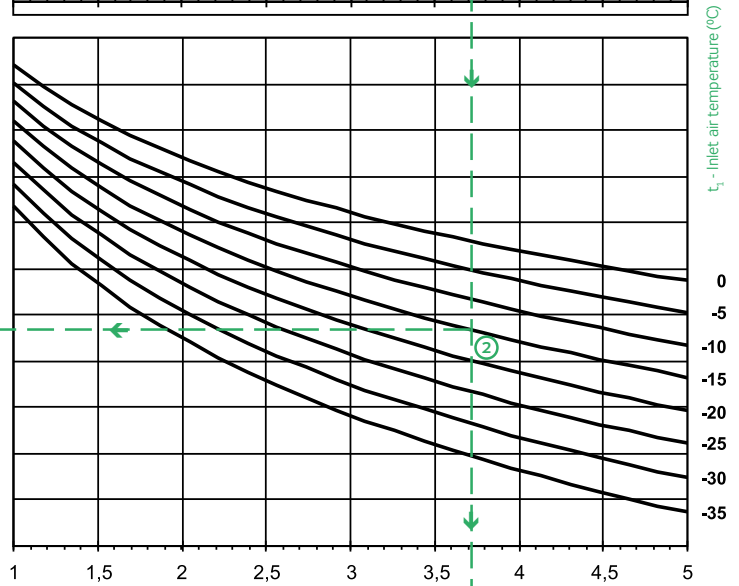
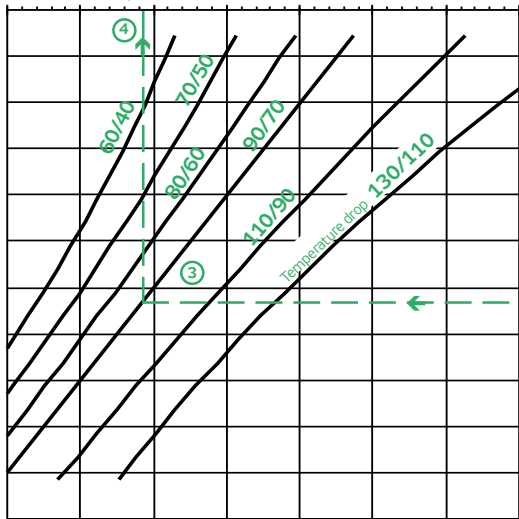

Example:
 At the selected air flow rate of 3730 m³/h ①, the velocity of the air flow through the VO 70-40 / 2R heater will be 3,7 m/s.
 For the selected air flow rate (speed) at inlet air temperature in front of the heater of -15 °C ②, and heating water temperature gradient of +90/+70 °C ③, the outlet air temperature behind the heater will be +23,5 °C ④.
 Heater output of 53,8 kW ⑦ comports with the selected air flow rate (speed) ① at the inlet air temperature in front of the heater ⑤ and the same water temperature gradient ⑥; while the required water discharge ⑨ will be 2,34 m³/h at water pressure loss ⑩ in a heater of 8,7 kPa.

Values in the nomogram can be interpolated and extrapolated.

VO 80-50/2R (Cu/Al vodní ohřivač 800 x 500 mm)

Nomogram of thermodynamic characteristics

Air flow rate - Inlet air temperature - Water

temperature gradient

Outlet air temperature - Output - Water discharge and pressure loss

t_2 - Outlet air temperature behind the heater (°C) →

V - air flow rate (m³/h) →

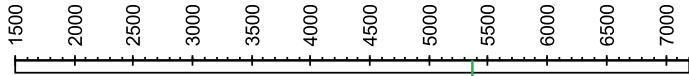

v - Air flow velocity in the heater (m/s) →

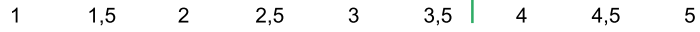

5 15 25 35 45 55 65 75

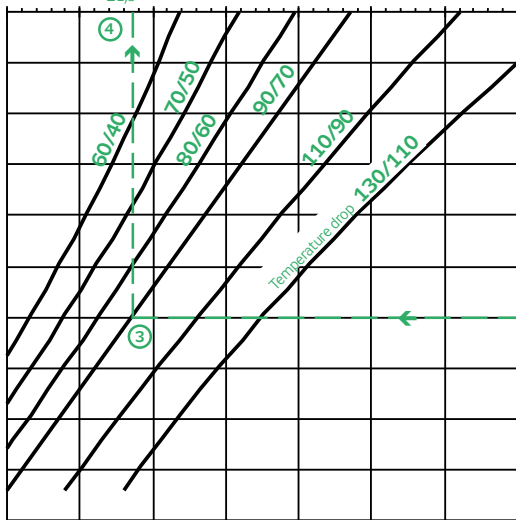

1 1,5 2 2,5 3 3,5 4 4,5 5

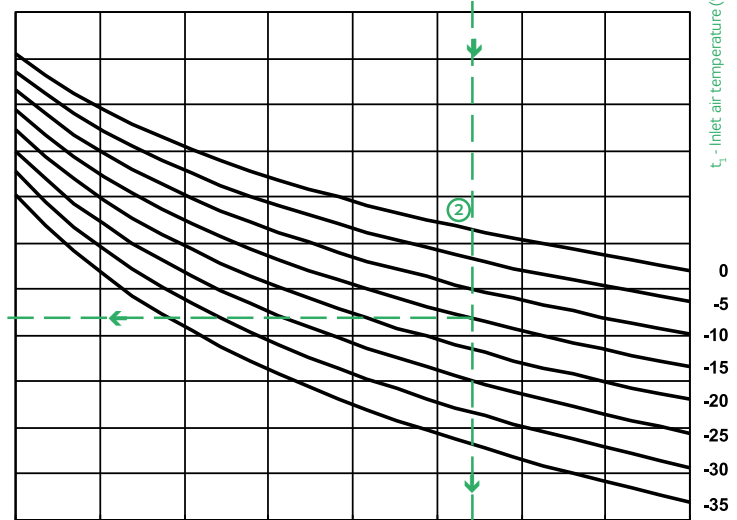

10 40 70 100 130 160

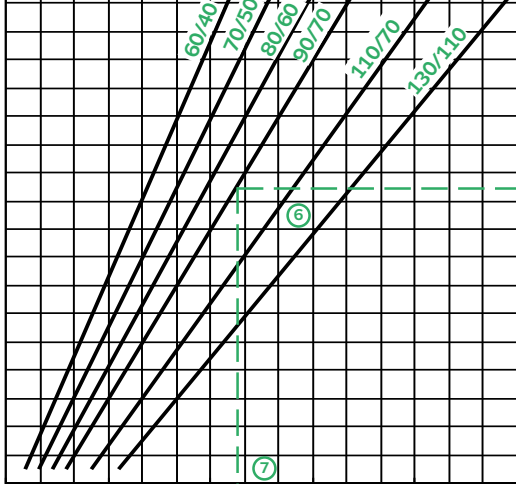

1 1,5 2 2,5 3 3,5 4 4,5 5

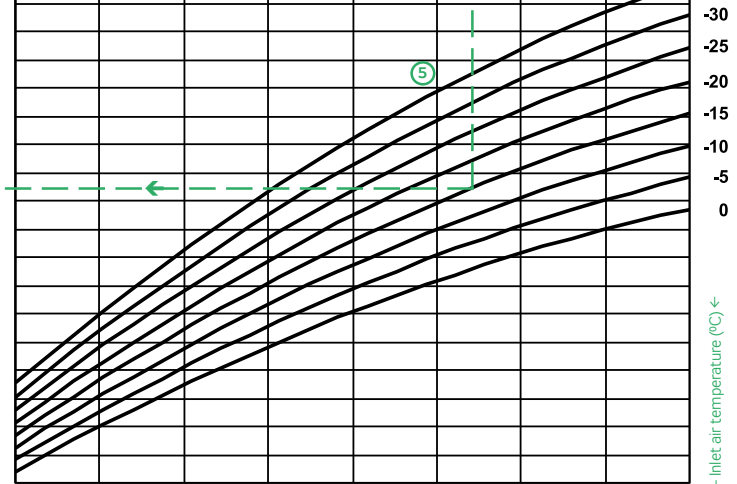

10 40 70 100 130 160

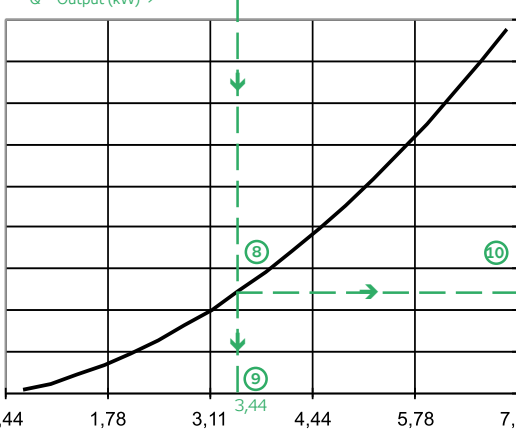

1 1,5 2 2,5 3 3,5 4 4,5 5

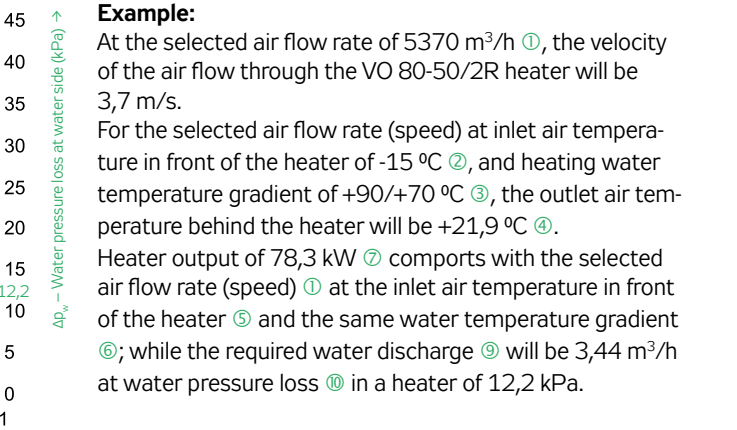

q_w - Water flow through the heater (m³/h) →

Δp_w - Water pressure loss at water side (kPa) →

Example:

At the selected air flow rate of 5370 m³/h ①, the velocity of the air flow through the VO 80-50/2R heater will be 3,7 m/s.
 For the selected air flow rate (speed) at inlet air temperature in front of the heater of -15 °C ②, and heating water temperature gradient of +90/+70 °C ③, the outlet air temperature behind the heater will be +21,9 °C ④.
 Heater output of 78,3 kW ⑦ comports with the selected air flow rate (speed) ① at the inlet air temperature in front of the heater ⑤ and the same water temperature gradient ⑥; while the required water discharge ⑨ will be 3,44 m³/h at water pressure loss ⑩ in a heater of 12,2 kPa.

Values in the nomogram can be interpolated and extrapolated.

- RP
- RQ
- RO
- RE
- RF
- RPH
- EX
- TR..
- EO..
- VO**
- SUMX
- CHV
- CHF
- HRV
- HRZ
- PRI

VO 90-50/2R (Cu/Al vodní ohřivač 900 x 500 mm)

Nomogram of thermodynamic characteristics

Air flow rate - Inlet air temperature - Water temperature gradient
 Outlet air temperature - Output - Water discharge and pressure loss

t_2 - Outlet air temperature behind the heater (°C) →
 -5 5 15 25 35 45 55 65 75

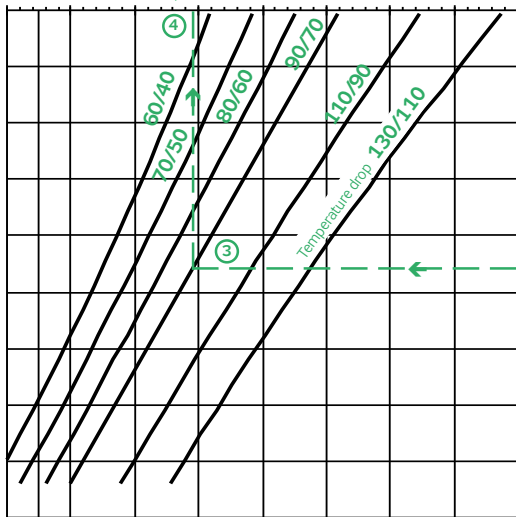

V - air flow rate (m³/h) →
 2500 3000 3500 4000 4500 5000 5500 6000 6500 7000 7500 8000

v - Air flow velocity in the heater (m/s) →
 1 1,5 2 2,5 3 3,5 4 4,5 5

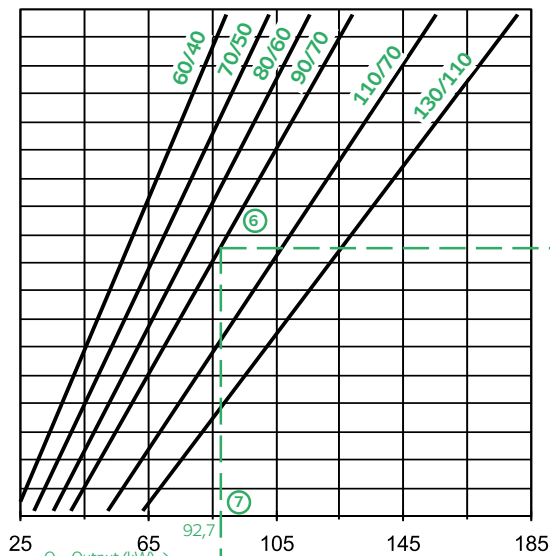
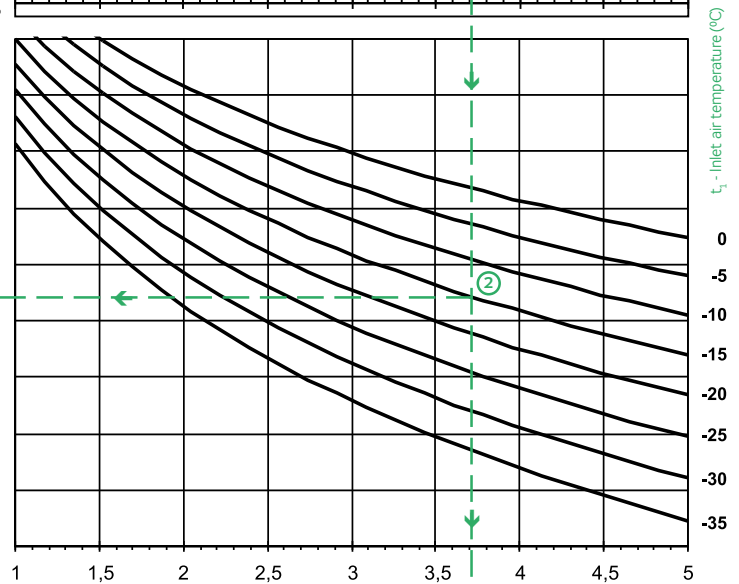

Q - Output (kW) →
 25 65 92,7 105 145 185

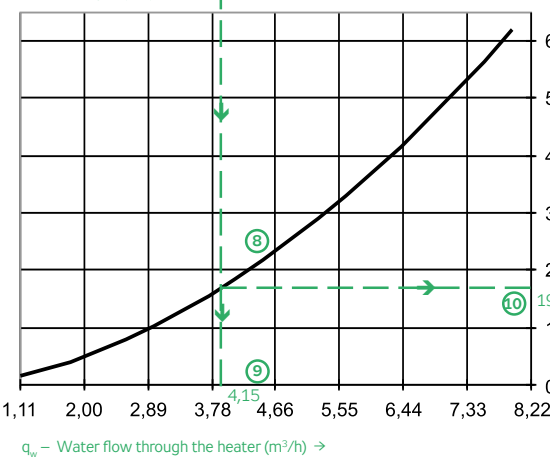
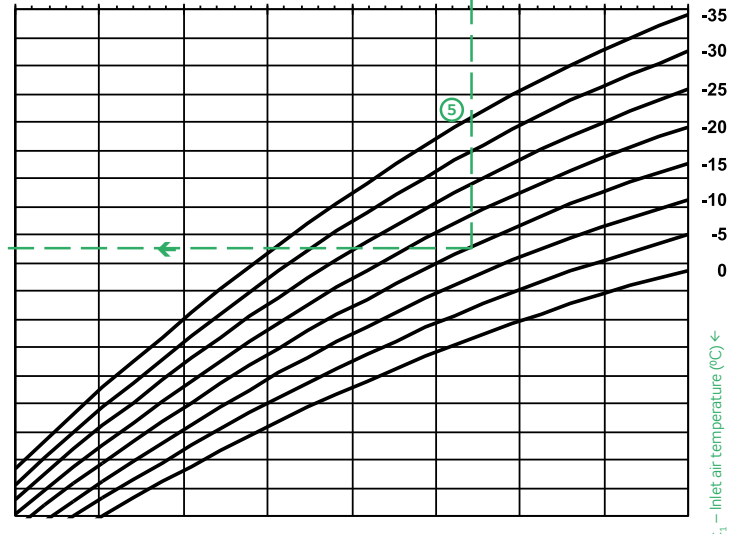

q_w - Water flow through the heater (m³/h) →

Example:

At the selected air flow rate of 6230 m³/h ①, the velocity of the air flow through the VO 90-50/2R heater will be 3,7 m/s.
 For the selected air flow rate (speed) at inlet air temperature in front of the heater of -15 °C ②, and heating water temperature gradient of +90/+70 °C ③, the outlet air temperature behind the heater will be +24,2 °C ④.
 Heater output of 92,7 kW ⑦ comports with the selected air flow rate (speed) ① at the inlet air temperature in front of the heater ⑤ and the same water temperature gradient ⑥; while the required water discharge ⑨ will be 4,15 m³/h at water pressure loss ⑩ in a heater of 19 kPa.

Values in the nomogram can be interpolated and extrapolated.

VO 40-20/3R (Cu/Al vodní ohřivač 400 x 200 mm)

Nomogram of thermodynamic characteristics

Air flow rate - Inlet air temperature - Water temperature gradient

Outlet air temperature - Output - Water discharge and pressure loss

V – air flow rate (m³/h) →

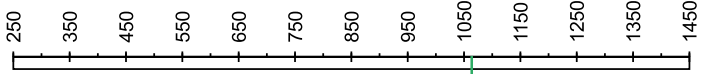

v – Air flow velocity in the heater (m/s) →

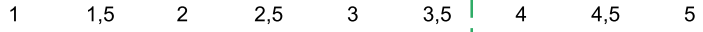

t₂ – Outlet air temperature behind the heater (°C) →

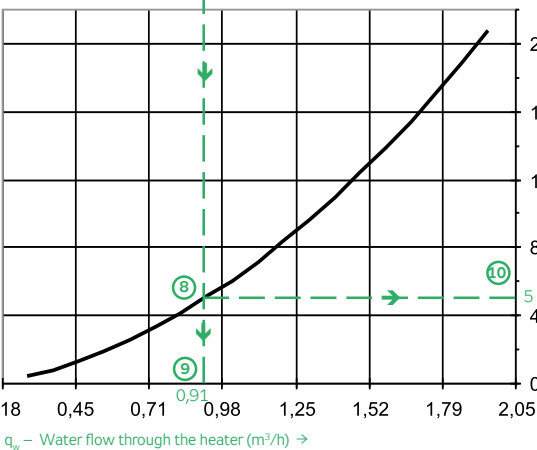
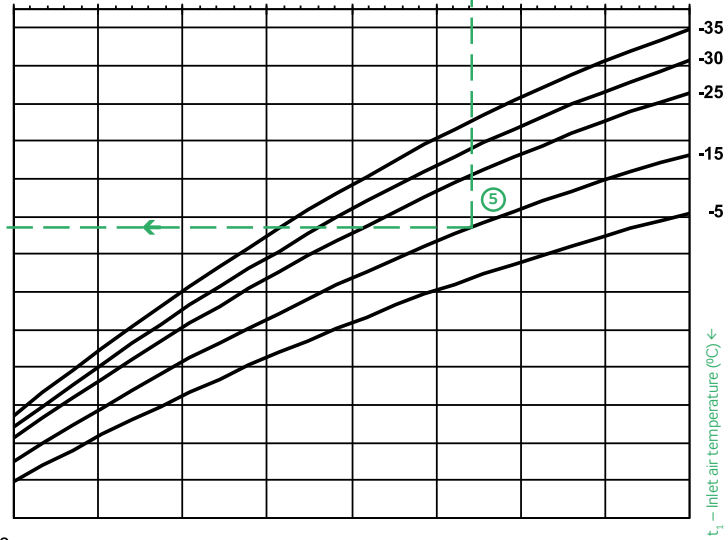
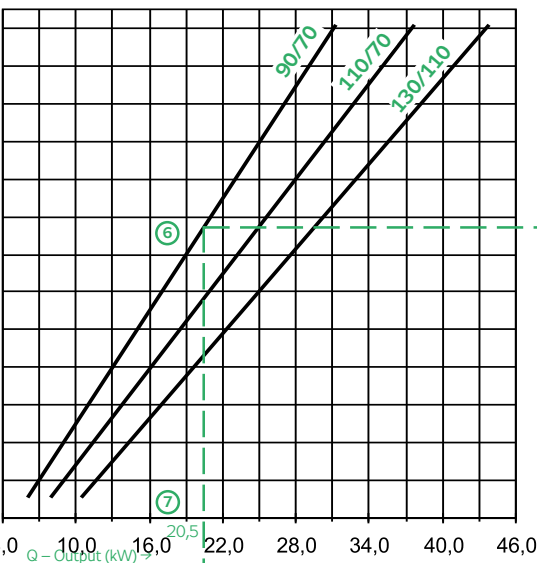
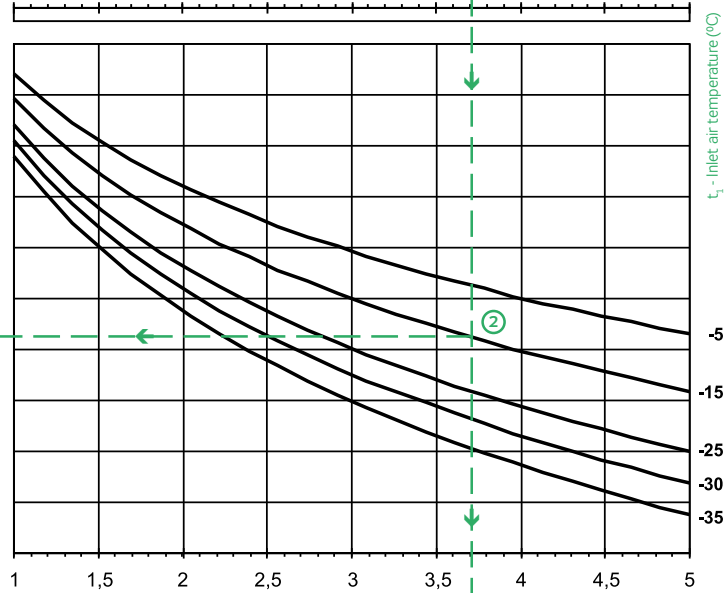
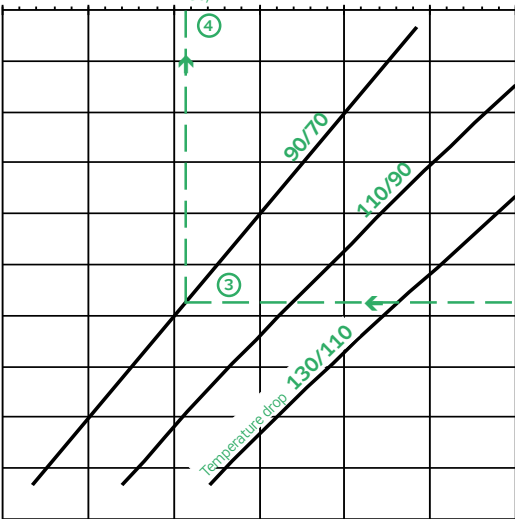
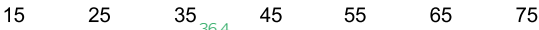

Δp_w – Water pressure loss at water side (kPa) →

Example:

At the selected air flow rate of 1065 m³/h ①, the velocity of the air flow through the VO 40-20/3R heater will be 3,7 m/s.
 For the selected air flow rate (speed) at inlet air temperature in front of the heater of -15 °C ②, and heating water temperature gradient of +90/+70 °C ③, the outlet air temperature behind the heater will be +36,4 °C ④.
 Heater output of 20,5 kW ⑦ comports with the selected air flow rate (speed) ① at the inlet air temperature in front of the heater ⑤ and the same water temperature gradient ⑥; while the required water discharge ⑨ will be 0,91 m³/h at water pressure loss ⑩ in a heater of 5 kPa.

Values in the nomogram can be interpolated and extrapolated.

q_w – Water flow through the heater (m³/h) →

- RP
- RQ
- RO
- RE
- RF
- RPH
- EX
- TR..
- EO..
- VO
- SUMX
- CHV
- CHF
- HRV
- HRZ
- PRI

VO 50-25/3R (Cu/Al vodní ohřivač 500 x 250 mm)

Nomogram of thermodynamic characteristics

Air flow rate - Inlet air temperature - Water temperature gradient
 Outlet air temperature - Output - Water discharge and pressure loss

t_2 - Outlet air temperature behind the heater (°C) →
 15 25 35 37,3 45 55 65 75

V - air flow rate (m³/h) →
 450 550 650 750 850 950 1050 1150 1250 1350 1450 1550 1650 1750 1850 1950 2050 2150 2250

v - Air flow velocity in the heater (m/s) →
 1 1,5 2 2,5 3 3,5 ① 4 4,5 5

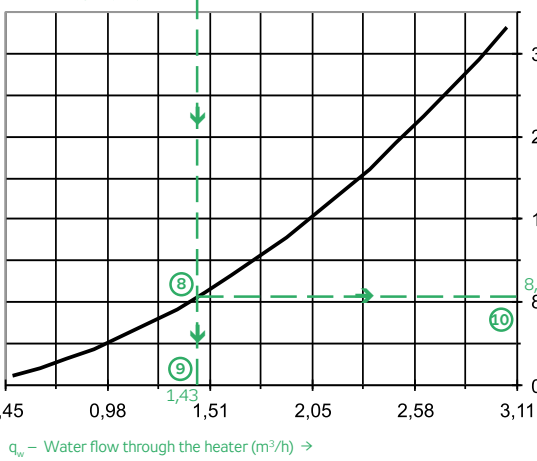
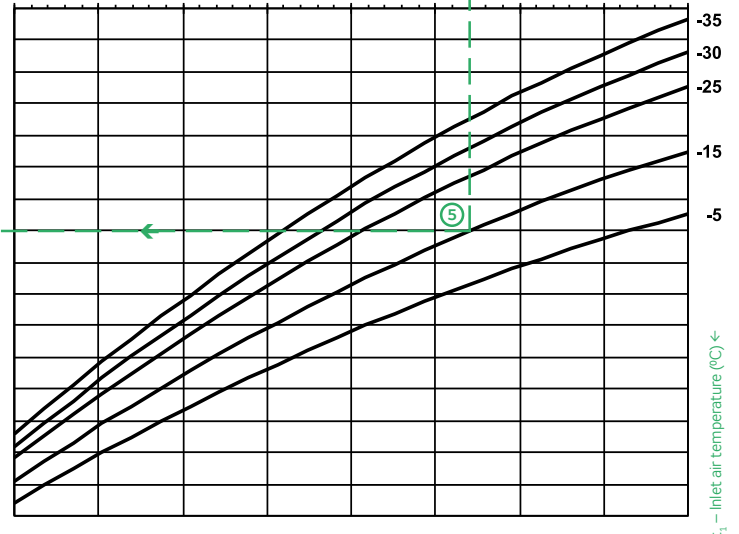
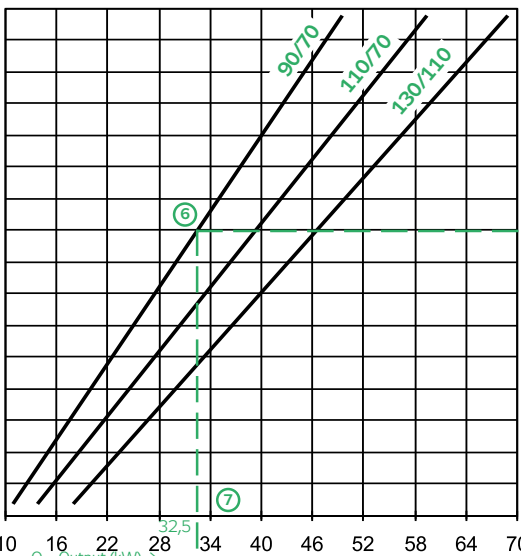
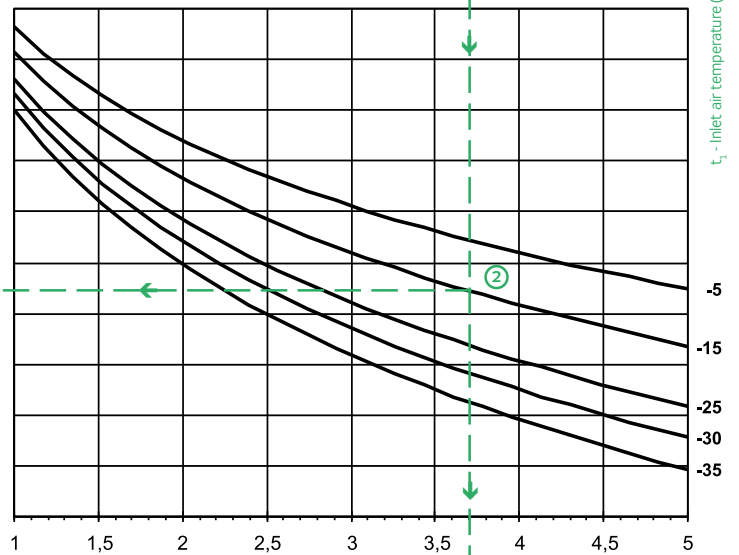
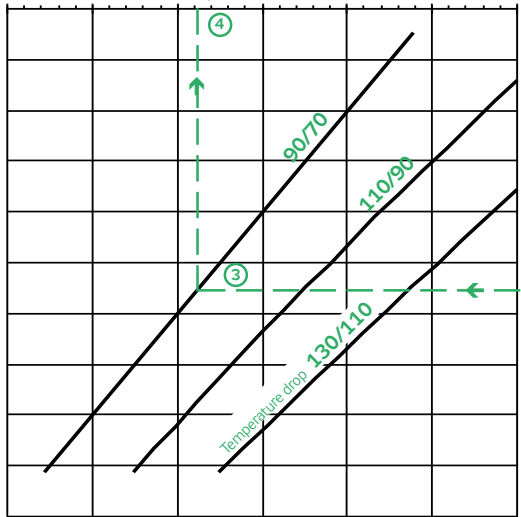

Example:
 At the selected air flow rate of 1675 m³/h ①, the velocity of the air flow through the VO 50-25/3R heater will be 3,7 m/s.
 For the selected air flow rate (speed) at inlet air temperature in front of the heater of -15 °C ②, and heating water temperature gradient of +90/+70 °C ③, the outlet air temperature behind the heater will be +37,3 °C ④.
 Heater output of 32,5 kW ⑦ comports with the selected air flow rate (speed) ① at the inlet air temperature in front of the heater ⑤ and the same water temperature gradient ⑥; while the required water discharge ⑨ will be 1,43 m³/h at water pressure loss ⑩ in a heater of 8,5 kPa.

Values in the nomogram can be interpolated and extrapolated.

VO 50-30/3R (Cu/Al vodní ohřivač 500 x 300 mm)

Nomogram of thermodynamic characteristics

Air flow rate - Inlet air temperature - Water temperature gradient

Outlet air temperature - Output - Water discharge and pressure loss

t_2 - Outlet air temperature behind the heater (°C) →

V - air flow rate (m³/h) →

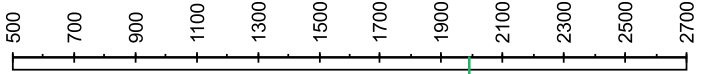

v - Air flow velocity in the heater (m/s) →

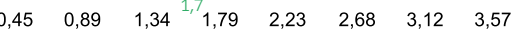
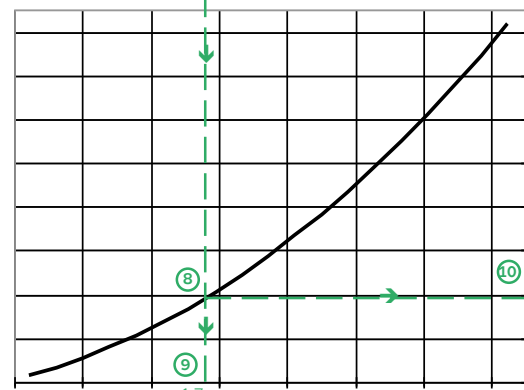
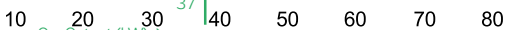
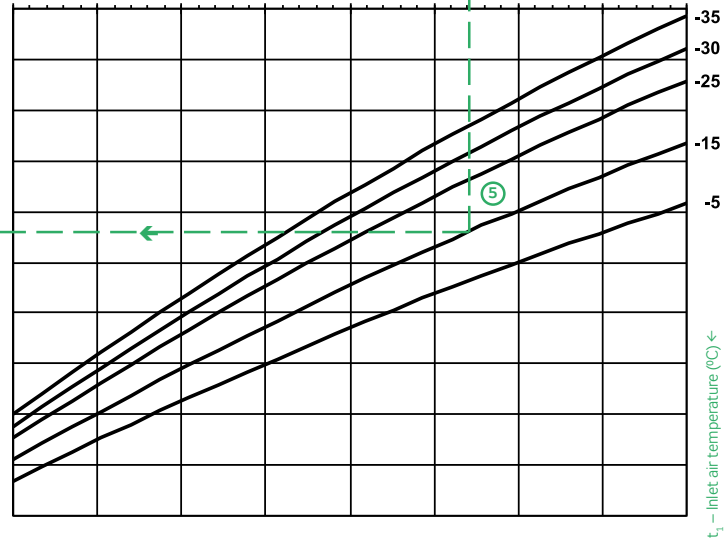
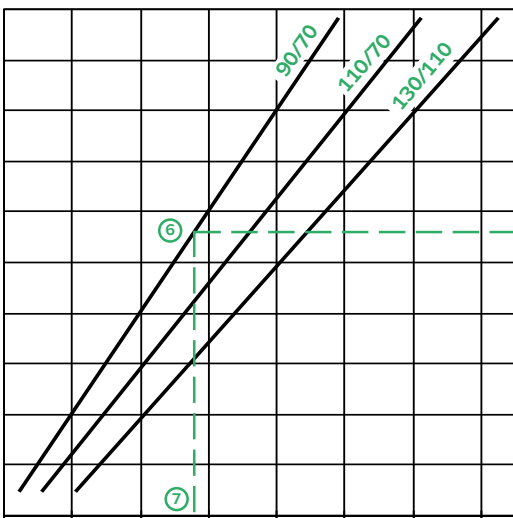
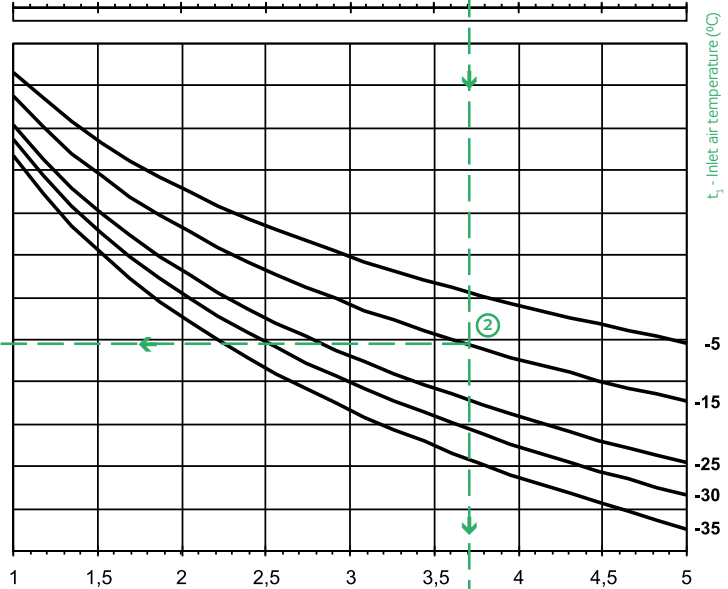
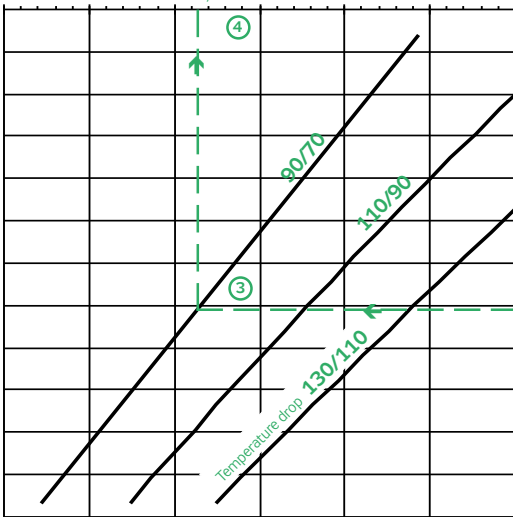
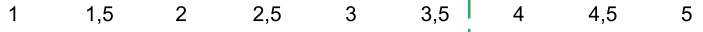

q_w - Water flow through the heater (m³/h) →

Δp_w - Water pressure loss at water side (kPa) →

Example:

At the selected air flow rate of 5328 m³/h ①, the velocity of the air flow through the VO 50-30/3R heater will be 3,7 m/s.

For the selected air flow rate (speed) at inlet air temperature in front of the heater of -15 °C ②, and heating water temperature gradient of +90/+70 °C ③, the outlet air temperature behind the heater will be +37,8 °C ④.

Heater output of 37 kW ⑦ comports with the selected air flow rate (speed) ① at the inlet air temperature in front of the heater ⑤ and the same water temperature gradient ⑥; while the required water discharge ⑨ will be 1,7 m³/h at water pressure loss ⑩ in a heater of 7,9 kPa.

Values in the nomogram can be interpolated and extrapolated.

- RP
- RQ
- RO
- RE
- RF
- RPH
- EX
- TR..
- EO..
- VO**
- SUMX
- CHV
- CHF
- HRV
- HRZ
- PRI

VO 60-30/3R (Cu/Al vodní ohřivač 600 x 300 mm)

Nomogram of thermodynamic characteristics

Air flow rate - Inlet air temperature - Water temperature gradient
 Outlet air temperature - Output - Water discharge and pressure loss

t_2 - Outlet air temperature behind the heater (°C) →
 15 25 35 45 55 65 75

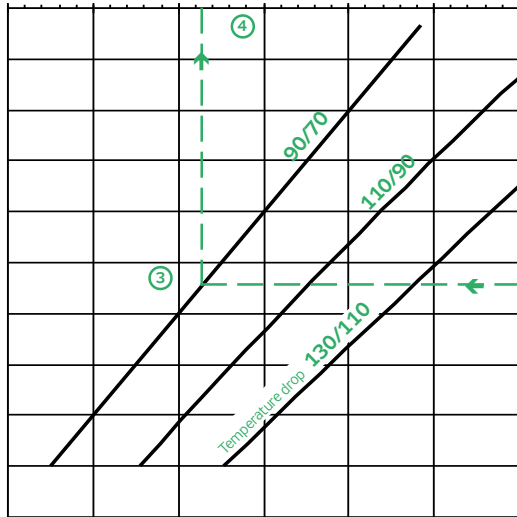

V - air flow rate (m³/h) →
 650 850 1050 1250 1450 1650 1850 2050 2250 2450 2650 2850 3050 3250

v - Air flow velocity in the heater (m/s) →
 1 1,5 2 2,5 3 3,5 4 4,5 5

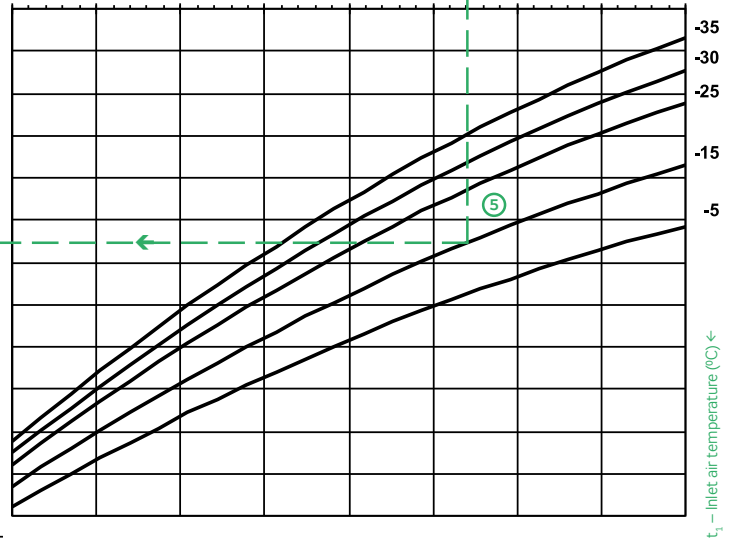
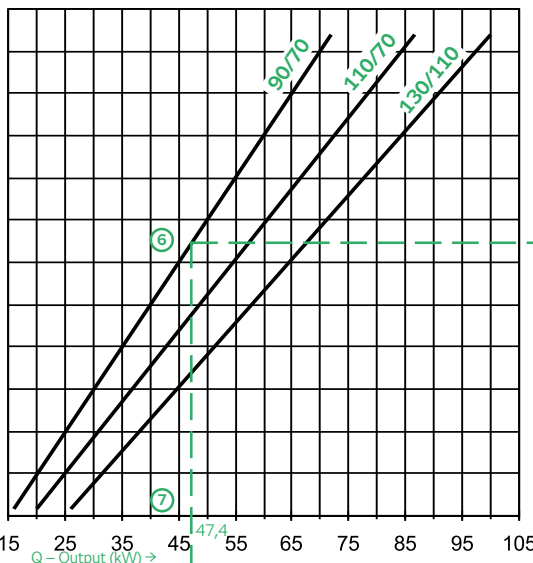
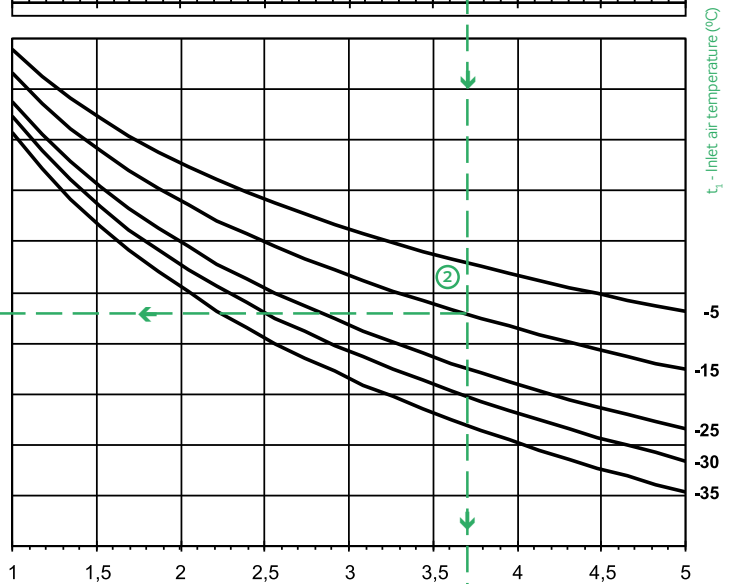

Q - Output (kW) →
 15 25 35 45 55 65 75 85 95 105

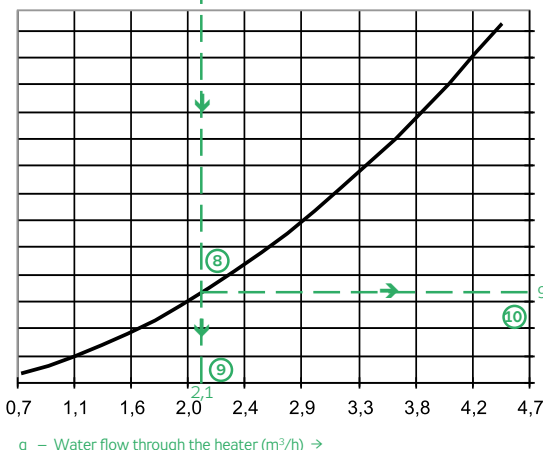

q_w - Water flow through the heater (m³/h) →

Δp_w - Water pressure loss at water side (kPa) →

Example:

At the selected air flow rate of 2410 m³/h ①, the velocity of the air flow through the VO 60-30/3R heater will be 3,7 m/s.

For the selected air flow rate (speed) at inlet air temperature in front of the heater of -15 °C ②, and heating water temperature gradient of +90/+70 °C ③, the outlet air temperature behind the heater will be +37,5 °C ④.

Heater output of 47,4 kW ⑦ comports with the selected air flow rate (speed) ① at the inlet air temperature in front of the heater ⑤ and the same water temperature gradient ⑥; while the required water discharge ⑨ will be 2,1 m³/h at water pressure loss ⑩ in a heater of 9,6 kPa.

Values in the nomogram can be interpolated and extrapolated.

VO 60-35/3R (Cu/Al vodní ohřivač 600 x 350 mm)

Nomogram of thermodynamic characteristics

Air flow rate - Inlet air temperature - Water temperature gradient

Outlet air temperature - Output - Water discharge and pressure loss

t_2 - Outlet air temperature behind the heater (°C) →

V - air flow rate (m³/h) →

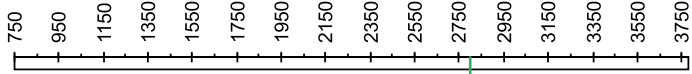

v - Air flow velocity in the heater (m/s) →

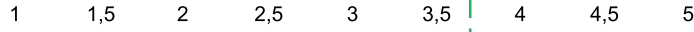

15 25 35 38,2 45 55 65 75

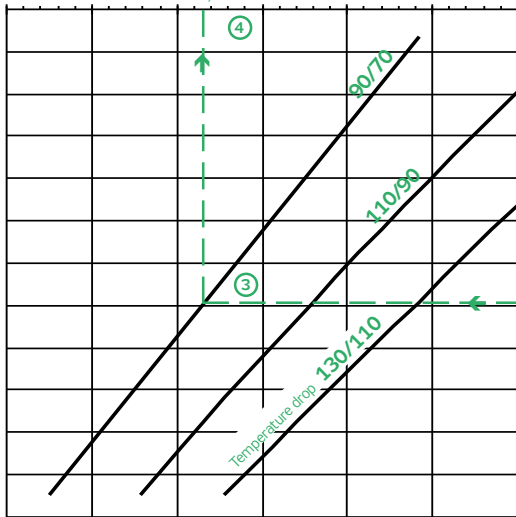

1 1,5 2 2,5 3 3,5 3,7 4 4,5 5

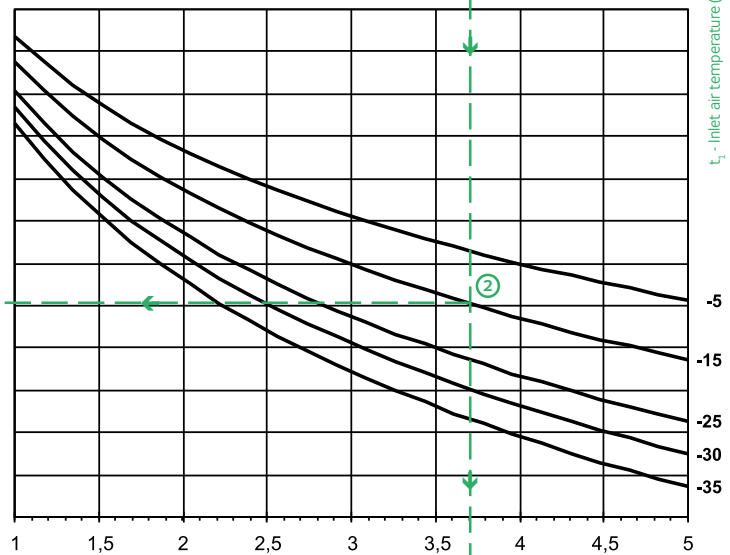

15 25 35 45 55 65 75 85 95 105 115

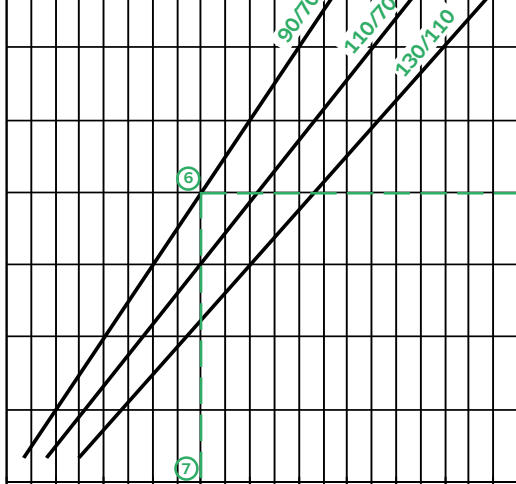

1 1,5 2 2,5 3 3,5 4 4,5 5

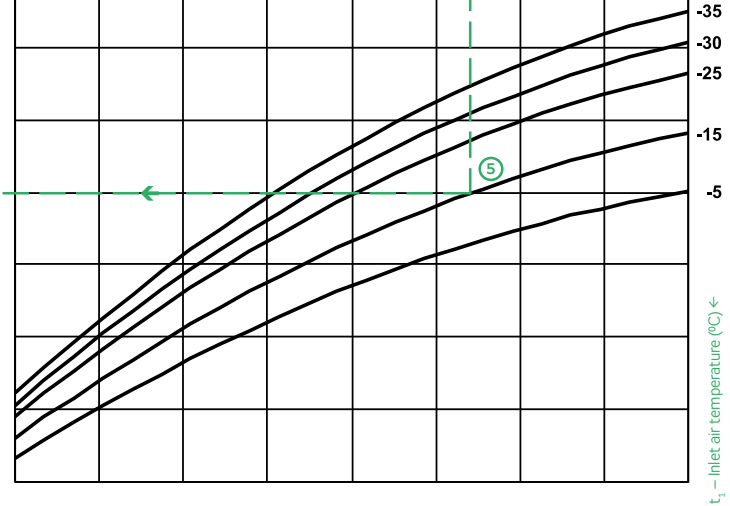

15 25 35 45 55 65 75 85 95 105 115

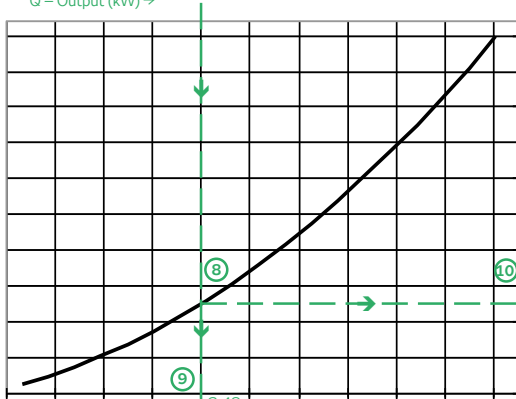

Δp_w - Water pressure loss at water side (kPa) →

Example:

At the selected air flow rate of 5328 m³/h ①, the velocity of the air flow through the VO 60-35/3R heater will be 3,7 m/s.
 For the selected air flow rate (speed) at inlet air temperature in front of the heater of -15 °C ②, and heating water temperature gradient of +90/+70 °C ③, the outlet air temperature behind the heater will be +38,2 °C ④.
 Heater output of 55,5 kW ⑦ comports with the selected air flow rate (speed) ① at the inlet air temperature in front of the heater ⑤ and the same water temperature gradient ⑥; while the required water discharge ⑨ will be 2,48 m³/h at water pressure loss ⑩ in a heater of 12,7 kPa.

q_w - Water flow through the heater (m³/h) →

Values in the nomogram can be interpolated and extrapolated.

- RP
- RQ
- RO
- RE
- RF
- RPH
- EX
- TR..
- EO..
- VO**
- SUMX
- CHV
- CHF
- HRV
- HRZ
- PRI

VO 70-40/3R (Cu/Al vodní ohřivač 700 x 400 mm)

Nomogram of thermodynamic characteristics

Air flow rate - Inlet air temperature - Water temperature gradient
 Outlet air temperature - Output - Water discharge and pressure loss

t_2 - Outlet air temperature behind the heater (°C) →
 15 25 35 38,2 45 55 65 75

V - air flow rate (m³/h) →
 1000 1500 2000 2500 3000 3500 3743 4000 4500 5000

v - Air flow velocity in the heater (m/s) →
 1 1,5 2 2,5 3 3,5 3,7 4 4,5 5

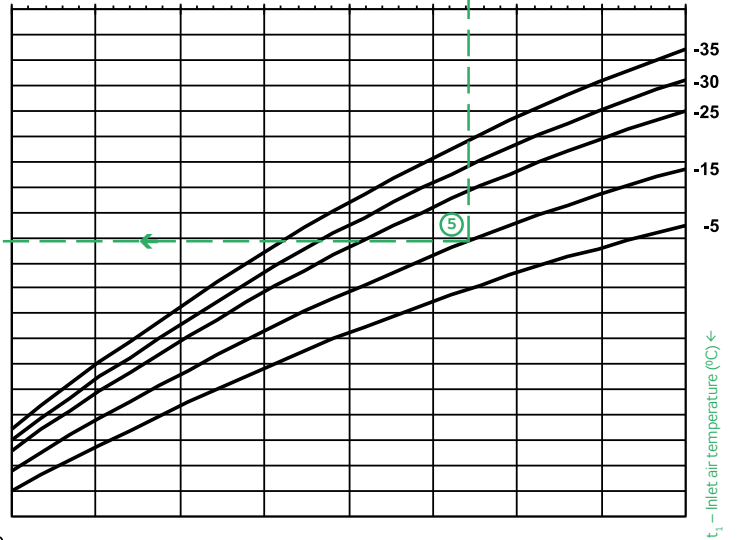
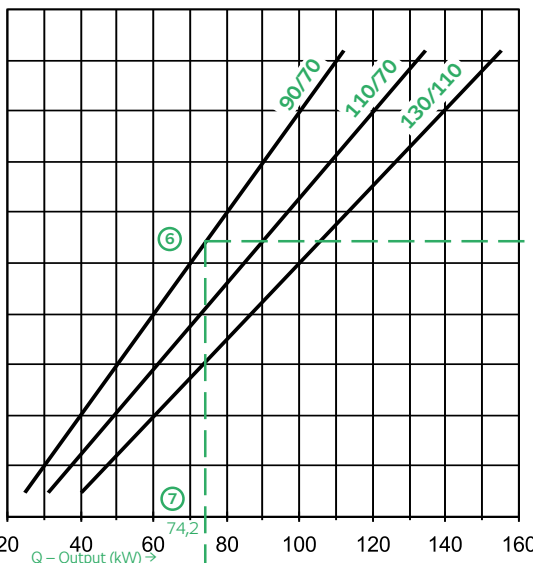
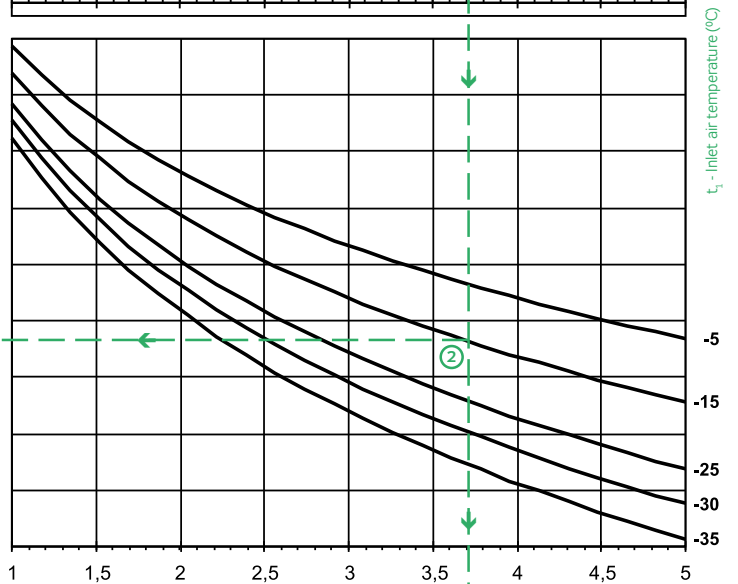
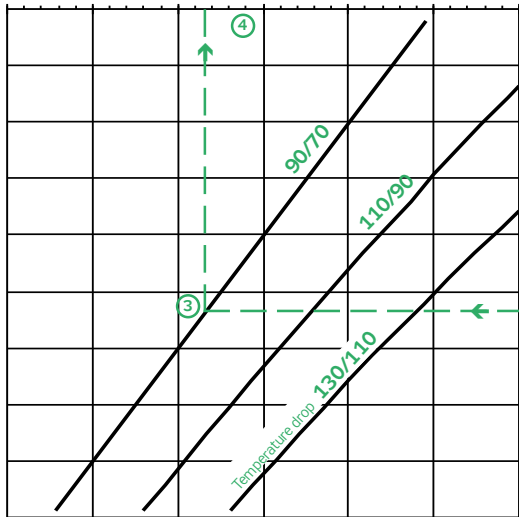

Q - Output (kW) →
 20 40 60 74,2 80 100 120 140 160

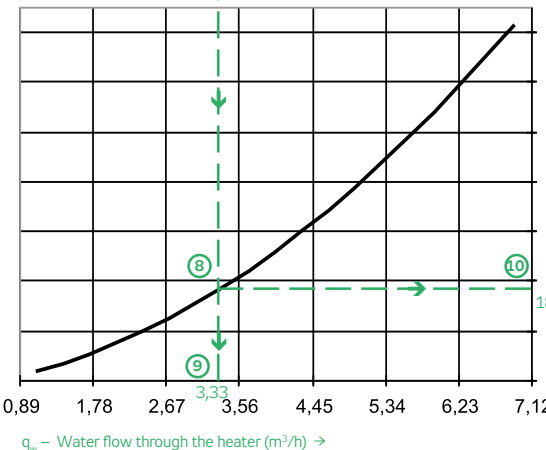

q_w - Water flow through the heater (m³/h) →
 0,89 1,78 2,67 3,33 3,56 4,45 5,34 6,23 7,12

Example:

At the selected air flow rate of 3743 m³/h ①, the velocity of the air flow through the VO 70-40/3R will be 3,7 m/s. For the selected air flow rate (speed) at inlet air temperature in front of the heater of -15 °C ②, and heating water temperature gradient of +90/+70 °C ③, the outlet air temperature behind the heater will be +38,2 °C ④. Heater output of 74,2 kW ⑦ comports with the selected air flow rate (speed) ① at the inlet air temperature in front of the heater ⑤ and the same water temperature gradient ⑥; while the required water discharge ⑨ will be 3,33 m³/h at water pressure loss ⑩ in a heater of 18,5 kPa.

Values in the nomogram can be interpolated and extrapolated.

VO 80-50/3R (Cu/Al vodní ohřivač 800 x 500 mm)

Nomogram of thermodynamic characteristics

Air flow rate - Inlet air temperature - Water temperature gradient

Outlet air temperature - Output - Water discharge and pressure loss

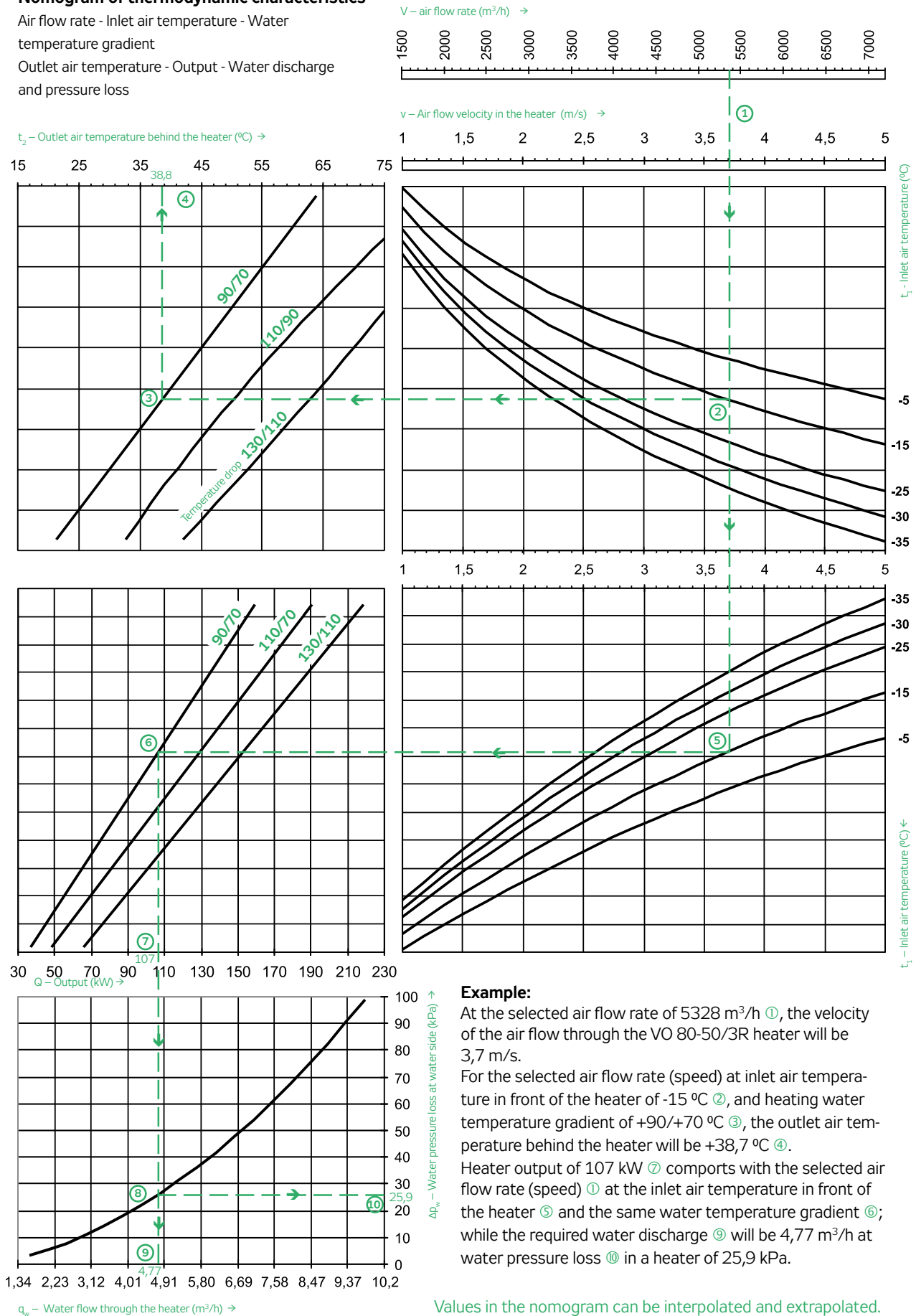

Values in the nomogram can be interpolated and extrapolated.

- RP
- RQ
- RO
- RE
- RF
- RPH
- EX
- TR..
- EO..
- VO**
- SUMX
- CHV
- CHF
- HRV
- HRZ
- PRI

VO 90-50/3R (Cu/Al vodní ohřivač 900 x 500 mm)

Nomogram of thermodynamic characteristics

Air flow rate - Inlet air temperature - Water temperature gradient
 Outlet air temperature - Output - Water discharge and pressure loss

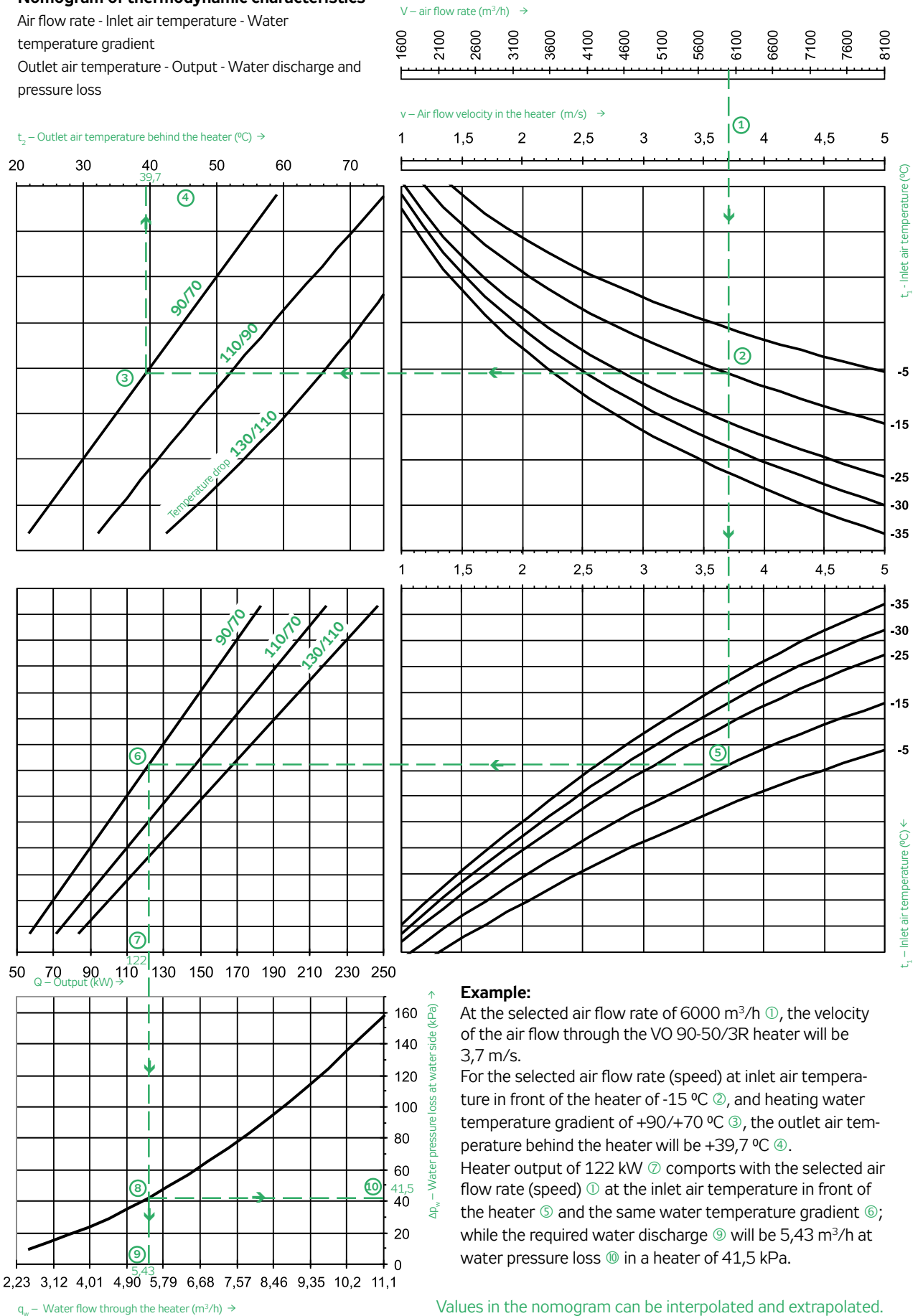

Example:
 At the selected air flow rate of 6000 m³/h ①, the velocity of the air flow through the VO 90-50/3R heater will be 3,7 m/s.
 For the selected air flow rate (speed) at inlet air temperature in front of the heater of -15 °C ②, and heating water temperature gradient of +90/+70 °C ③, the outlet air temperature behind the heater will be +39,7 °C ④.
 Heater output of 122 kW ⑦ comports with the selected air flow rate (speed) ① at the inlet air temperature in front of the heater ⑤ and the same water temperature gradient ⑥; while the required water discharge ⑨ will be 5,43 m³/h at water pressure loss ⑩ in a heater of 41,5 kPa.

Values in the nomogram can be interpolated and extrapolated.

NOMOGRAM OF AIR PRESSURE LOSSES FOR ALL VO HEATERS

The curve of pressure losses is valid for all VO heaters. The air pressure loss depends on the air flow velocity, and it is calculated for the air velocity in a free cross section of all Vento system dimensional ranges.

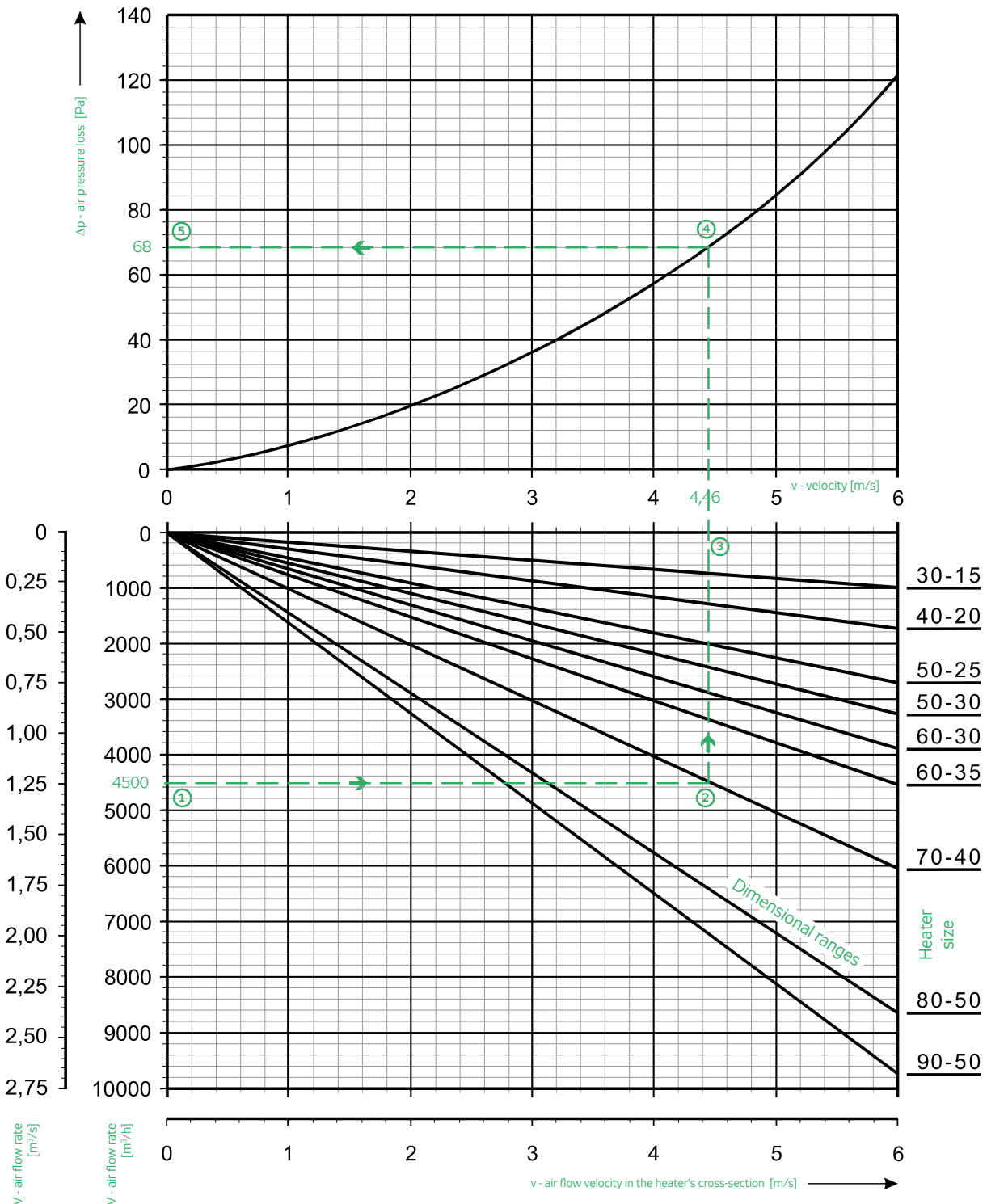

The nomogram of pressure losses is valid for all VO heaters. For the selected air flow rate ①, the air flow velocity ③ in the free heater's cross-section ②, can be read in the lower graph, and then the corresponding heater's air pressure loss ⑤ at the known velocity can be determined in the upper part ④.

Example:

At an air flow rate of 4,500 m^3/h , the velocity of the air flow in the VO 70-40 heater will be 4.46 m/s. The heater's air pressure loss for VO 70-40/2R at the above-mentioned air flow rate will be 68 kPa.

- RP
- RQ
- RO
- RE
- RF
- RPH
- EX
- TR..
- E0..
- VO**
- SUMX
- CHV
- CHF
- HRV
- HRZ
- PRI

RP
RQ
RO
RE
RF
RPH
EX
TR.
EO..
VO
SUMX
CHV
CHF
HRV
HRZ
PRI

HEATER ACCESSORIES

Water heaters in air-handling systems are reliable only if completed with accessories which ensure the following essential functions:

- Air-venting
- Antifreeze protection
- Output control

Ideally, they should always be used along with accessories of the Vento system, which ensure inter-compatibility and balanced parameters..

AIR-VENTING OF THE HEATER

The heater can be vented either manually or automatically. With regard to the fact that the heater is mostly installed in places difficult to access, at height or on ceilings, automatic air-venting is a necessity. The TACO automatic air-venting valve with outer G1/2" thread (see fig. #6) is designed to be screwed directly into the heater header pipe. It is installed on the very top of the headers.⁵⁾

Max. allowed operating parameters of heating water:

- Max. water operating temperature: **115 °C**⁶⁾
- Max. water operating pressure: **0,85 MPa**
- Min. water operating pressure: **20 kPa**

The valve must be installed in the vertical position or aslant with its head upwards, respectively horizontally; in no case downwards!

OBRÁZEK 6 – ODVZDUŠŇOVACÍ VENTIL TACO

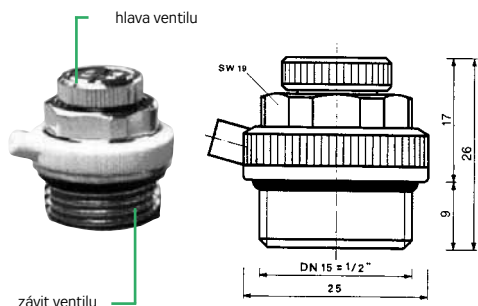

Minimum water pressure in the system ensures that even if the pressure in the intake part of the mixing set drops, the air-venting valve will not take up air into the outlet heater header pipe.

Warning!

The following antifreeze solutions can be used as heating media:

- water plus ethylenglycol (Antifrogen N)
- water plus 1,2-propylenglycol (Antifrogen L)

They enable the freezing temperature of the heating media to be dropped depending on the solution concentration.

⁵⁾ For detailed instructions, refer to the section Installation, Maintenance and Service.

⁶⁾ If the heating water temperature for the water heater operation is +116 °C or higher, it will be necessary to ensure air-venting by a float valve.

Other antifreeze agents can be used only upon presenting confirmation from the manufacturer on their compatibility with swelling materials (inserts).

ANTIFREEZE PROTECTION ACCESSORIES

Antifreeze protection of the heater is created by comprehensive interconnected equipment preventing freezing of the heater in normal operating conditions. The section only includes devices which are directly connected to or associated with the heater.

Temperature Sensors for Control Units

The temperature of the water flowing through the heater must be continuously measured and evaluated by the control unit. The NS 130R sensor (resistance Ni 1000), which is equipped with an action reading element situated in the casing made of stainless steel - class 17 248, is used to measure the water temperature.

The casing is provided with G1/2" outer thread, and it is intended for direct mounting into the bottom hole in the heater's header for return water (after removing the blinding plug from the header).

FIGURE 7 - TYPES OF TEMPERATURE SENSORS

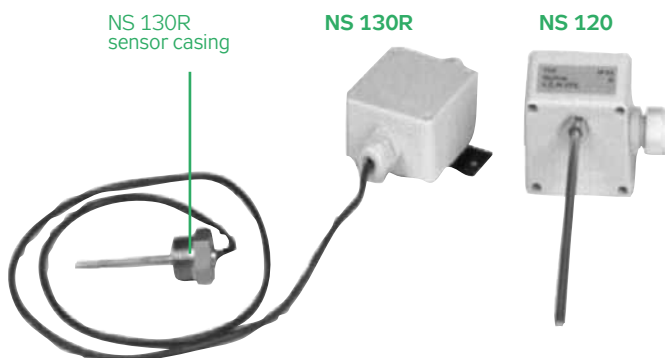

INSTALLATION

- VO heaters and mixing sets, as well as other Vento elements and equipment, are not intended, due to their concept, for direct sale to end customers. Each installation must be performed in accordance with a professional project created by a qualified air-handling designer who is responsible for proper selection of the heater and accessories. The installation and commissioning can be performed only by a specialized installer company licensed in accordance with valid regulations (if wiring is needed, specialized also in wiring).
- If water is used as the heating medium, the heater can then be situated only in an indoor environment where the temperature is maintained above freezing point (this does not apply for heated air).
- Outdoor use is not recommended. It is allowed only if antifreeze solution is used as the heating medium (mostly ethylene glycol solution at a concentration corresponding to the temperatures).
- There is no need for individual suspensions to install the water heaters. The heater can be inserted into the duct line, but it must not be exposed to any strain or torsion caused by the connected duct line.
- The TACO air-venting valves must be mounted onto the highest point of the inlet/outlet header pipe. The openings in the header pipes have G1/2" inner thread and were closed with plugs in the plant.
- The casing of the antifreeze protection NS 130 sensor can be mounted on the bottom side of the header pipe.
- An air filter must always be placed in front of the heater to avoid heater fouling.
- The heater can be situated either in front of or behind the fan. However, if the heater is in front of the fan, the heater output must be controlled so that the air temperature will not exceed the maximum allowed value for the given fan.
- The heater can be situated either in front of or behind the fan. However, if the heater is in front of the fan, the heater output must be controlled so that the air temperature will not exceed the maximum allowed value for the given fan.
- If the heater is situated behind the fan, we recommend inserting a 1-1.5 m long straight duct between the fan and the heater to calm the air flow down.
- The counter-current connection of the heater is needed to achieve maximum output (see fig. # 8).
- All calculations and nomograms included in the section "Water Heaters" are valid for the counter-current connection of the heaters. Such concurrent connection provides lower output, but it is more frost resistant. (1)
- The sophisticated design of the heaters enables you to turn on one heater arbitrarily, and you will always be able to arrange counter-current connection and install the valves and thermal sensor in the right place. (2)
- If the heater is covered by a ceiling, it is necessary to ensure access to the entire heater to enable checking and service; especially air-venting valves need checking and maintenance.

OPERATION, MAINTENANCE AND SERVICE

The water heater requires regular maintenance at least at the beginning and end of the heating season. During operation, it is necessary to check proper air venting and water leakages, respectively increasing pressure losses in the water piping or air duct (due to fouling). It is necessary to supervise pump and actuator operation, and keep the mixing set's filters clean. If the air-handling system is stopped due to the action of the antifreeze protection, the reason must be found and removed following the procedure included in the Installation Manual, in the section "Troubleshooting".

All important system protection functions, including antifreeze protection of the mixing sets and heaters, must be permanently controlled by the control unit.

Attention! During the winter season, the control unit must not be disconnected from the power supply for too long! Power supply failure during air-handling system operation is especially dangerous!

FIGURE 8 - HEATER'S POSITIONS

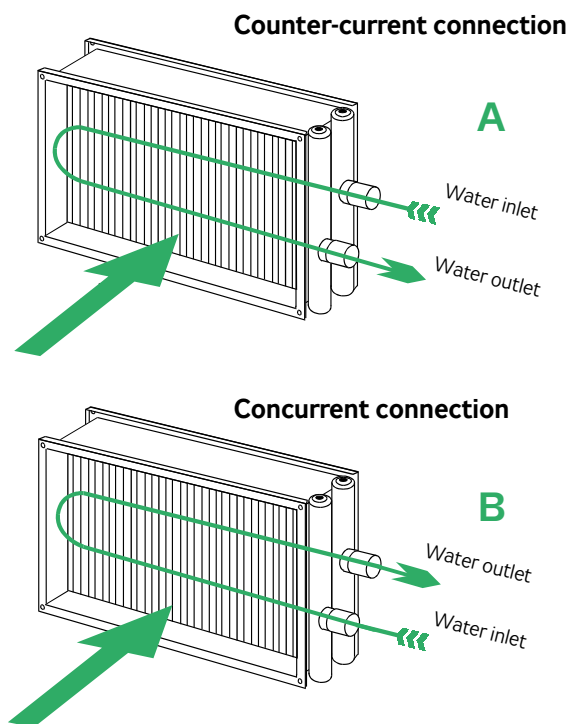

1) If the anti-freeze protection is correctly designed, the above-mentioned feature of the concurrent connection is insignificant.
 2) Therefore, only one version of the heaters is used in the Vento system (no right or left versions).

RP
RQ
RO
RE
RF
RPH
EX
TR..
EO..
VO
SUMX
CHV
CHF
HRV
HRZ
PRI