

DVV-EX Roof Fan

For ventilation of explosion hazardous areas



DVV-EX

Roof Fan for normal ventilation and smoke/heat extract



Roof fans DVV-Ex are designed to exhaust potentially explosive atmospheres (mixtures of air and inflammables such as gases and steam) from explosion hazardous areas. The DVV-Ex fans have impellers with backward-curved blades and IEC motor in explosion protection "flameproof enclosure" - Ex d. The casing is manufactured from seawater-resistant aluminium and the base frame from hot dip galvanised steel, with a copper inlet cone. Suitable for exhaust from zones 1 or 2, field of application II, for gases of groups A

and B and temperature classes T1 to T4. The fans are classified to category 2G. Marking of the serial equipped fan (c = constructional protection): II 2G c IIB T4. Terminal box in explosion protection "increased safety" - II 2G Ex e IIC T5/T6 is mounted on the casing. Up to request additionally equipped and marked fans are available to achieve extended temperature respectively gas range:

- II 2G c IIB T3 (-20<Ta<55°C)
- II 2G c IIB+H2 T3 (-20<Ta<55°C)
- II 2G c IIB T4 (-40<Ta<40°C)

To enable protection of motor from

overheating DVV-Ex fans have serial built-in thermistors (PTC) with external leads (connection to U-EK230E motor protection relay as accessories possible).

Speed control is possible via frequency converter.

Two speed motor is available on request.

On request the fan can be factory fitted with sound attenuator HSDV (accessories) on outlet (marking of the fan DVVI-Ex).

General

Systemair explosion proof fans have been developed to be used in effective supply and exhaust air systems allocated to category 2 (zone 1) and category 3 (zone 2) in explosion hazardous areas.

All fans are manufactured in accordance with ATEX guideline 94/9/EG certified for EC countries. Certificates can be downloaded from our homepage.

The fans are suitable for mounting in above mentioned explosion hazardous zones, for extraction of gases.

The ignition temperature of the medium, but also the classification in explosion groups is important. Explosion proof fans from Systemair are approved (according to type) for the transportation of substances corresponding to explosion group IIA, IIB and partially IIC.

Group	Some gases and vapours of substances
IIA	acetone, ammonia, ethylene, fuel oil, benzene, methane, propane
IB	ethylene, diethyl ether
IIC	hydrogen only

Table relates to ATEX classifications

Performance

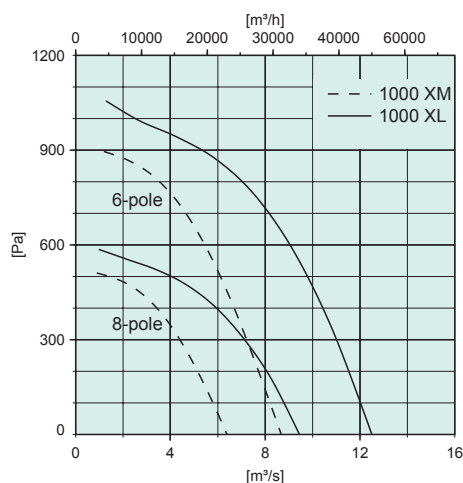
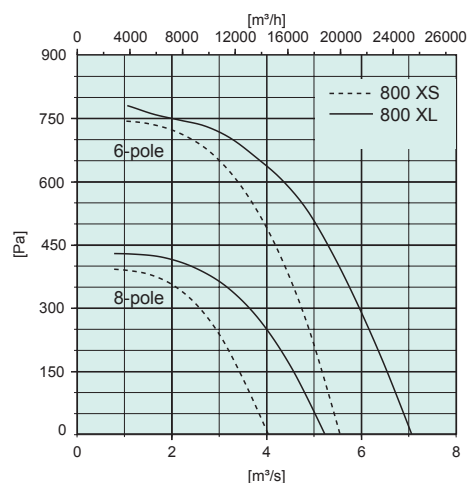
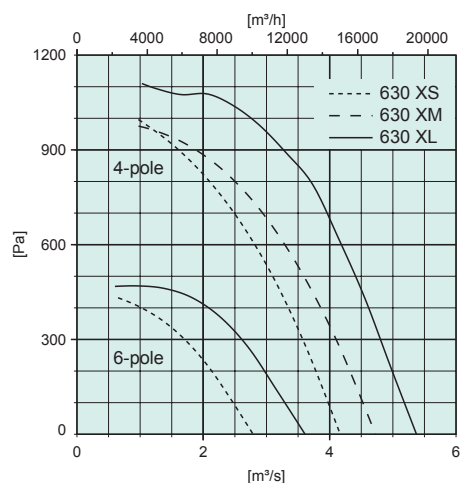
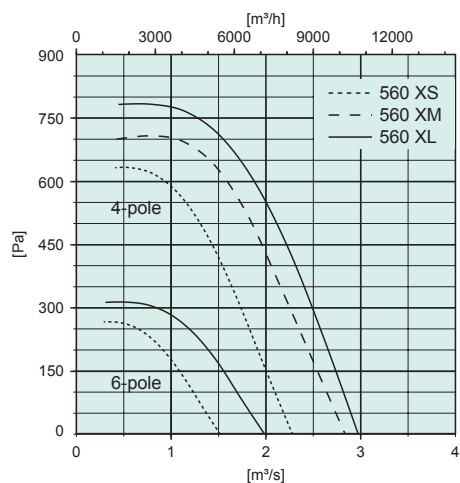

Technical data

Model 3x400V, 50Hz	Item No. DVV-EX	Input power P1 [kW]	Current [A]	Max. airflow [m³/h]	R. p. m. [min ⁻¹]	Sound pressure level at 4/10 m [dB(A)]	Weight [kg]
DVV-EX 560D6-XS	95418	0,52	1,5	5350	968	56/49	103
DVV-EX 560D4-XS	95416	1,35	2,4	7900	1410	66/59	103
DVV-EX 560D4-XM	95433	1,85	3,4	10200	1419	68/61	106
DVV-EX 560D6-XL	95419	0,85	1,8	7100	947	59/52	103
DVV-EX 560D4-XL	95417	2,77	4,8	10700	1429	69/62	114
DVV-EX 630D6-XS	95423	1,19	2,6	9900	950	61/53	134
DVV-EX 630D4-XS	95422	3,77	6,6	15000	1424	71/63	145
DVV-EX 630D4-XM	95424	4,5	8	17000	1444	73/66	159
DVV-EX 630D6-XL	95421	1,84	3,6	12780	946	64/58	145
DVV-EX 630D4-XL	95420	5,67	9,9	19345	1448	75/69	183
DVV-EX 800D8-XS	95426	1,49	3,57	14500	718	59/53	236
DVV-EX 800D6-XS	95425	3,38	6,5	19370	966	66/60	260
DVV-EX 800D8-XL	95428	2,22	4,7	18800	717	65/57	257
DVV-EX 800D6-XL	95427	5,14	9,9	25400	966	71/64	274
DVV-EX 1000D8-XM	95432	2,52	6,7	23000	741	65/57	364
DVV-EX 1000D6-XM	95431	5,86	12,1	30600	980	73/65	379
DVV-EX 1000D8-XL	95430	4,6	9	34000	727	66/58	369
DVV-EX 1000D6-XL	95429	10,37	18,7	45000	964	74/66	405

Motor insulation class F, IP55, S1 duty.

Dimensions

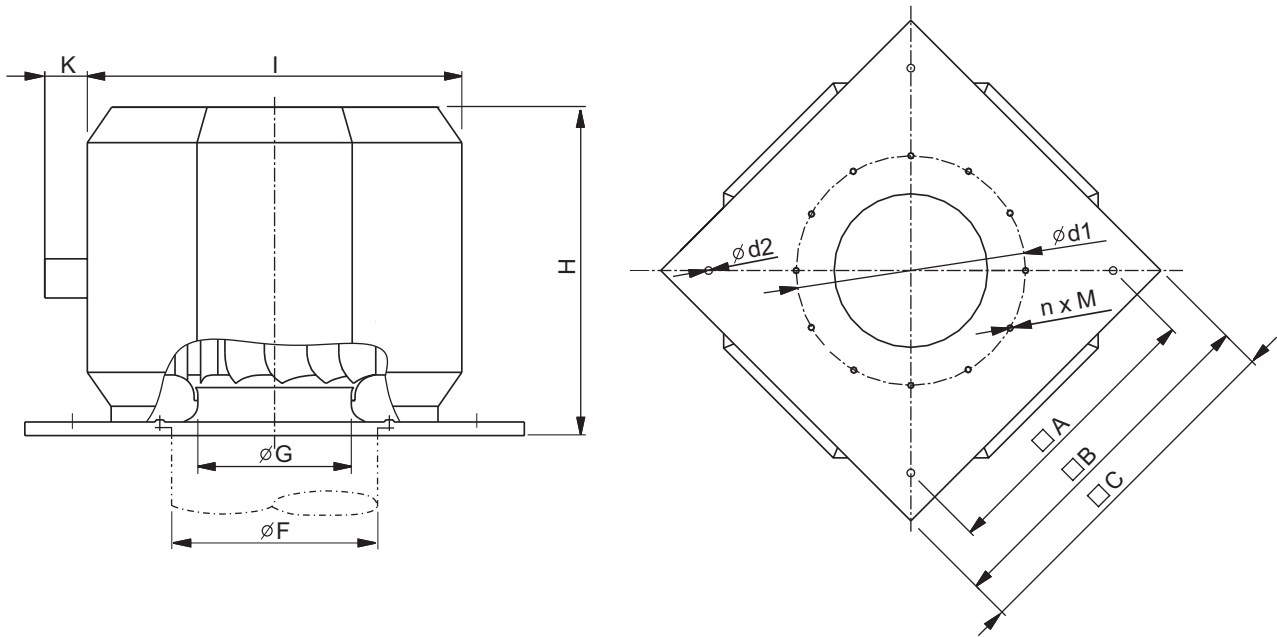

Model	□ A	□ B	□ C	$\varnothing F$	$\varnothing G$	H	I	K	$\varnothing d1$	$\varnothing d2$	n x M
DVV-EX 560	750	939	943	560	361	990	892	90	620	14	12 x M8
DVV-EX 630	840	1035	1039	630	451	964	1100	90	690	14	12 x M8
DVV-EX 800	1050	1251	1255	800	581	1105	1350	90	860	14	16 x M8
DVV-EX 1000	1050	1251	1255	800	675	1490	1500	90	860	14	16 x M8

Wiring diagram

(only direct start possible)

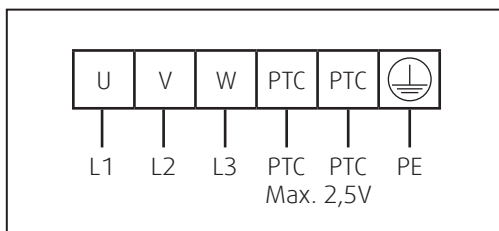

DVV-EX installation examples

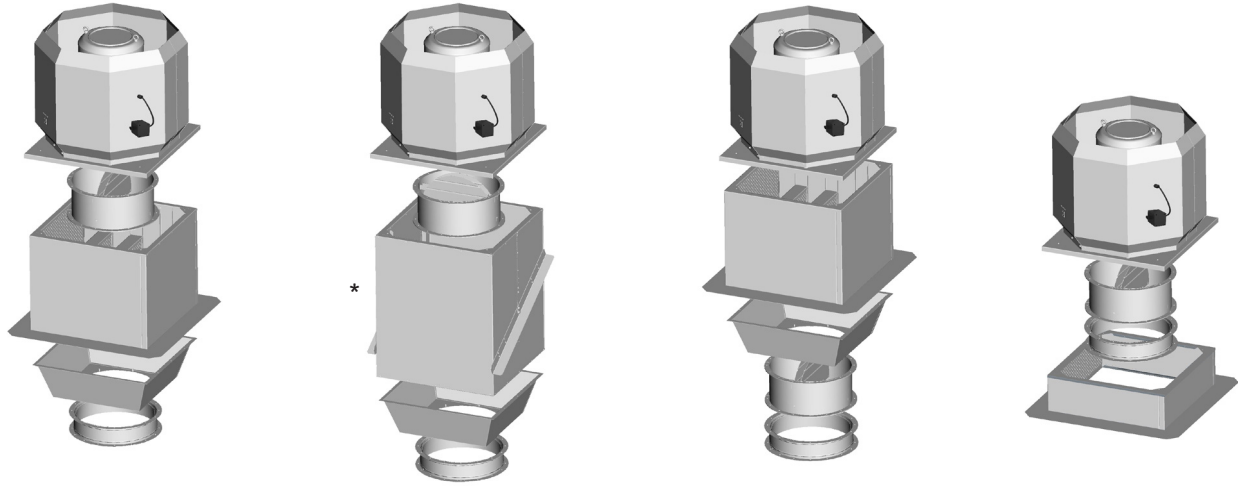

* Note: Accessorie available on request

Accessories

Details of following and electrical accessories are on-line available.

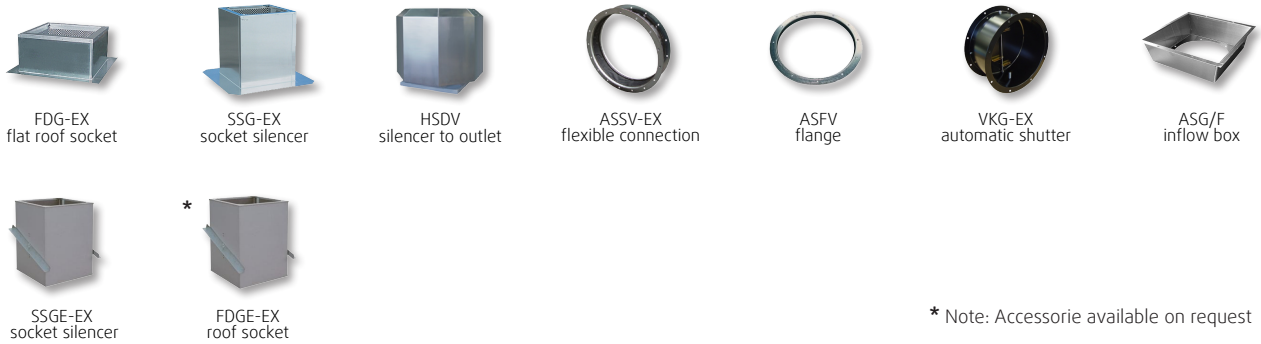

* Note: Accessorie available on request

Ordering key

DVV-EX 1000D6-XL

