

**LOSSNAY HEAT RECOVERY VENTILATOR (RESIDENTIAL USE)**
**MODEL**
**VL-250CZPVU-R-E  
VL-250CZPVU-L-E  
VL-350CZPVU-R-E  
VL-350CZPVU-L-E**
**Installation Manual**
**For dealer/contractor**

\* The figure shows VL-350CZPVU-R-E

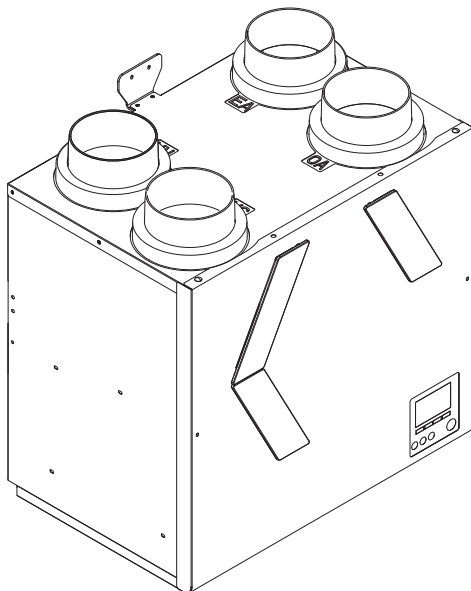

## Contents

1. Safety Precautions .....	2
2. Outside Dimensions .....	6
3. Standard Installation Example .....	10
3.1 Installation example .....	10
3.2 Working space .....	11
4. Installation Procedure .....	13
4.1 Wall bracket .....	13
4.2 Mounting the Product.....	13
4.3 Fixing the Product .....	13
4.4 Connecting Pipe.....	14
4.5 Connecting drain piping .....	15
5. Electrical Work .....	16
5.1 Standard use .....	16
5.2 External device connection use .....	17
■ Post-installation Checks .....	22
6. How to use Controller .....	23
6.1 Controller button functions.....	23
6.2 Menu structure .....	24
6.3 «Main menu» screen and operation .....	25
6.4 Commissioning menu .....	25
6.5 Function setting .....	41
6.6 Error list .....	44
6.7 Trial operation .....	44
7. Explaining to the User.....	46







- This product is for residential use.
- This product must be correctly installed to ensure that its performance and functions are properly demonstrated and to ensure its safe use and operation. Before installation, please read this installation manual thoroughly. Before using exclusive system components, read the installation manual for the system components thoroughly.
- For installation parts, be sure to use accessories and designated parts. Use of non-designated parts may be a cause of malfunction.
- Installation must be performed by dealers and electrical contractors. Incorrect installation by the customer may be a cause of equipment malfunction or an accident.
- Electrical work must be performed by a properly qualified electrician of the dealer or electrical contractor.
- Please note that enough working space (remove the cover, replace the filter, etc.) is required around the product for maintenance.
- Install the product indoor.







# 1. Safety Precautions

The following symbols indicate the degree of danger caused by incorrect handling of the product.

	<b>WARNING</b>		<b>CAUTION</b>
Incorrect handling of the product may result in serious injury or death.		Incorrect handling may result in minor injury or physical damage to the house or household goods.	

Symbols used in the text and on the main unit have the following meanings.

	Prohibited		Do not install in bathroom
	Do not disassemble		Be sure to ground
	Do not wet		Follow instructions

 <b>WARNING</b>	
 Prohibited	<p><b>Do not install the product in hot places, in the direct sunlight and in smoky places.</b> Failure to heed this warning may result in fire.</p>
 Do not disassemble	<p><b>Do not modify or disassemble the product beyond that is necessary.</b> Failure to heed this warning may result in fire, electric shock or injury.</p>
 Do not wet	<p><b>Refrain from immersing in water or splashing the product with water.</b> Failure to heed this warning could result in short circuit or electric shock.</p>
 Do not install in bathroom	<p><b>Do not install the product or the controller in a bathroom or other humid location.</b> Failure to heed this warning may result in electric shock or electric leakage.</p>
 Be sure to ground	<p><b>Make sure to install the ground wire.</b> Device failure and electric leakage may cause electric shock.</p>
 Follow instructions	<p><b>Use 220 to 240 V AC power.</b> Failure to heed this warning may result in fire, electric shock or damage to the circuit boards.</p> <p><b>For the outdoor air intake vent, choose a position where combustion gas or other similar exhaust air is not sucked in and the vent is not buried by snow.</b> Inability to bring in fresh air may result in lack of oxygen in the room.</p> <p><b>Select a place which is strong enough to support the product, and install the product securely.</b> Injury could result if parts fall.</p> <p><b>Electrical work must be carried out safely and reliably by a professional electrical contractor (properly qualified electrician) in accordance with internal wiring provisions and electrical-equipment technical standards.</b> Poor connection and faulty electrical work could result in electric shock or fire.</p> <p><b>Install an all-pole power supply isolator at the power supply side as per local electrical regulations. All supply circuits must be disconnected before obtaining access to the terminal devices. Use the specified cable size and connect the cables securely to prevent disconnection when they are pulled.</b> If there is a defect in the connection, there is a possibility of fire.</p> <p><b>Use the designated electric wires, and connect them securely so that they do not come loose.</b> Defective connections may result in fire.</p> <p><b>When metal ducts penetrate through metal-sheeted wooden buildings or structures, install the product so that there is no electrical contact between the metal ducts and the metal sheeting.</b> Electric leakage may cause ignition.</p> <p><b>Make sure to cover with the terminal block cover after electrical work.</b> Failure to heed this warning may cause dust, humidity, etc. to enter, resulting in electric leakage or fire.</p> <p><b>Secure duct piping with commercially available fixing bands, aluminum tape, etc. to prevent piping from coming loose. Install outdoor piping from the product so that it is tilted at a downward pitch of at least 1/30 towards the outside.</b> Failure to heed this warning may cause rain penetration, resulting in electric shock/fire or water damage to household property.</p> <p><b>If the product will not be operated for a long period of time after installation, make sure to turn off the circuit breaker.</b> It could cause electrical shock by deteriorated insulation or fire by the electric leakage.</p> <p><b>For installation work parts, make sure to use only accessories and designated parts</b> Use of non-designated parts may result in equipment damage or accidents.</p>

# **WARNING**



Follow  
instructions

**When using duct heaters (supply air preheaters, supply air after-heaters), make sure to use safety devices that do not have self-return functions. Do not supply the duct heaters with electricity directly from the product.**  
Failure to heed this warning may result in fire.

**When using duct heaters (supply air preheaters, supply air after-heaters) that do not have temperature control functions, select duct heaters that have the appropriate capacity according to the airflow passing through the heaters.**

Failure to heed this warning may result in fire because the heaters will overheat if the airflow is too little compared to the capacity of heaters.

# CAUTION



Prohibited

**Do not install the product at regions or locations that exceed the following operating conditions.**

If these operating conditions are exceeded, dew condensation water might drip.

Outdoor air temperature: -15 to 40 °C

Area around the product and ambient temperature and humidity: 0 to 40 °C 80%RH or less and at absolute humidity or less where the dew point temperature of 12 °C (20 °C 60%RH or equivalent) is reached under the above minimum outdoor air temperature conditions

**Do not install the product at locations where the product is prone to be damaged from salt or hot springs.**

Failure to heed this warning may result in malfunction of product.

**When installing the product, do not drop or throw the product, or subject the product to impact.**

Damage to structures inside the product may result in air or water leakage.

**Do not carry with a pipe guide.**

Failure to heed this warning may result in damage to pipe guide.

**Do not place the product directly on the floor.**

Failure to heed this warning may result in damage to the drain pipe and the control box.

**<The product>**

**The product is exclusively vertical mounting type.**

**If the product is used horizontally, household belongings can get wet by drained water or condensation.**

**Install the product and the duct piping on the indoor side of the insulation layer/airtight layer.**

The temperature of the air after heat is collected on the indoor side of the insulation layer may drop, or drain or dew condensation might result in the ceiling getting wet.

**Install the product (on the wall) in the direction of the duct connecting flange so that it is horizontal (within  $\pm 1^\circ$ ).**

Water leakage may result in water damage to the floor.

**Wear gloves when installing.**

Failure to heed this warning may result in injury.

**Securely install parts so that they are not twisted or deformed.**

Injury could result if parts fall.

**Install the product by two persons.**

Failure to heed this warning may result in product damage or injury if the product falls.

**A power supply isolator must be installed.**

Install in a position where the isolator will not be wet by water from the power cord when condensation on the exterior surface of the product drops.

**Install in a position where the power cord can be replaced when damaged.**

Otherwise, the power cord cannot be replaced.

**Make sure to connect wiring properly according to the wiring diagram.**

Misconnection may cause malfunction.

**<Duct piping>**

**Make sure to insulate ducts down to the base of the duct connecting flanges.**

Exposed parts get cold in winter, which may result in dew condensation forming due to moisture in the room.

**Do not allow duct piping to contact the inspection opening, ceiling hanging bolts, beams, pillars, and other duct piping.**

Failure to heed this warning may result in abnormal noise and vibration.

**Use an outdoor hood, that makes it less likely for rain water, snow or small animals (for example, bats) from entering the ends of the supply air and exhaust air ducts.**

To prevent the entry of small animals, install an outdoor hood having louvers 2 cm or less wide.

**When the product is anticipated not to be operated continuously, insulate the RA (Return Air) side ducts.**

Indoor humidity can cause condensation because exposed parts can become cold in winter.

**Place the duct heaters (supply air preheaters, supply air after-heaters) at least 2 m from the product.**

Failure to heed this warning may cause damage on the product due to the preheating from the heaters.

**<Drain piping>**

**Make sure to connect drain piping by the following procedure to prevent freezing and dew condensation forming on the surface of the piping**

- Connect the drain piping on the indoor side of the insulation layer

- Insulate the drain piping up to the end of the piping

- Do not let the end of drain piping be immersed in the rain gutter, etc.

(At times of heavy snow, the rain gutter freezes and drain water is not discharged, which results in water leaking from the product.)

**Do not use duct booster fan on the RA/EA duct or the OA/SA duct.**

If an external force is applied to the built-in bypass damper, the damper may be fixed on the bypass side, when it is switching between Heat exchange mode and Bypass mode, and heat exchange may be prevented.

**This appliance is not intended for use by persons (including children) with reduced physical sensory or mental capabilities, or lack of experience and knowledge, unless they have been given supervision or instruction concerning use of the appliance by a person responsible for their safety. Children should be supervised to ensure that they do not play with the appliance. (This appliance can be used by children aged from 8 years and above and persons with reduced physical, sensory or mental capabilities or lack of experience and knowledge if they have been given supervision or instruction concerning use of the appliance in a safe way and understand the hazards involved. Children shall not play with the appliance. Cleaning and user maintenance shall not be made by children without supervision.)**



Follow instructions



## Note

- Do not install the product at locations where toxic gas or gas containing corrosive components such as acids, alkaline, organic solvents, or paints is generated. (Failure to heed this warning may result in malfunction.)  
Do not install the product near bedrooms. (Failure to heed this warning may cause complaints about noise.)
- For living rooms (for example, bed rooms) where it is anticipated that building ambient noise will be below 30 dB(A), use commercially available ducts that have sound deadening qualities on the supply air side. (Sound from the product resonates inside the ducts and may result abnormal noise being emitted from the air vent.)
- Install supply air and exhaust air grills at locations where they are less likely to reverberate. (Failure to heed this warning may cause complaints about noise.)
- In cold regions or regions with strong winds, wind outside sometimes gets inside when operation of the product is stopped. So, we recommend providing a motorized shutter midway along the supply air and exhaust air ducts.
- Install the product so that discharged gas or exhaust air from burning appliances and equipment does not flow back inside the product.
- At the outdoor hood installation position, allow at least 3x the diameter of the duct through holes between the outdoor hood and the ducts so that exhaust air is not mixed in with supply air. (Preferably a distance of 450 mm or more should be ensured between the outdoor hood and the ducts.)
- Do not connect duct pipes in the ways shown below. (Failure to heed this warning may cause the air flow to decrease or result in abnormal noise.)

- Extremely sharp bends



- Many bends



- Bending right next to the duct connection flange

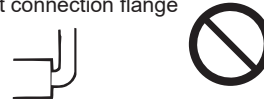

- Extreme narrowing of the duct diameter

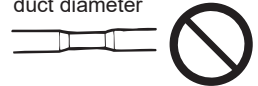

- Use an exhaust air filter that has a non-woven fabric type filter.
- To reduce the noise of drain discharge, make sure to connect commercially available check valves to the drain piping. Use check valves in line with their instructions.
- The opening face of the drain piping edge must have a vertical downward lack of water. Make the opening at the end of the drain piping face down so that water drains well.
- Make sure to install a drain pipe independently. (When you connect common drainage pipe of an apartment house, it may cause backflow of drain.)
- The duct from the outdoor hood should have an uphill slope of 1/30 or more. (It may cause rainwater to enter the inside of duct.)





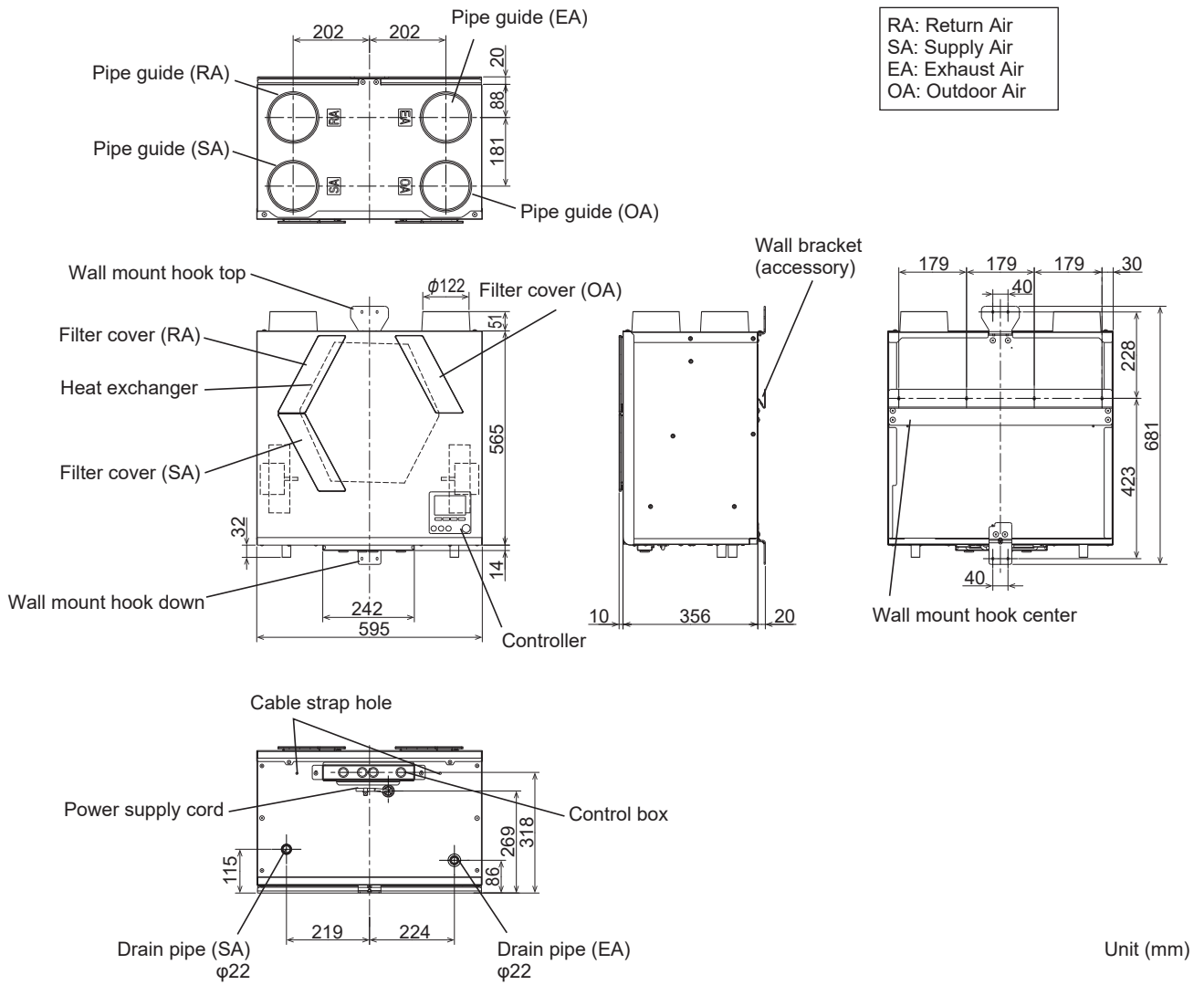

# 2. Outside Dimensions

## ■VL-250CZPVU-R-E

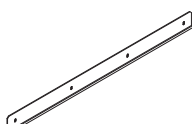

Unit (mm)

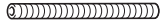
### Accessories





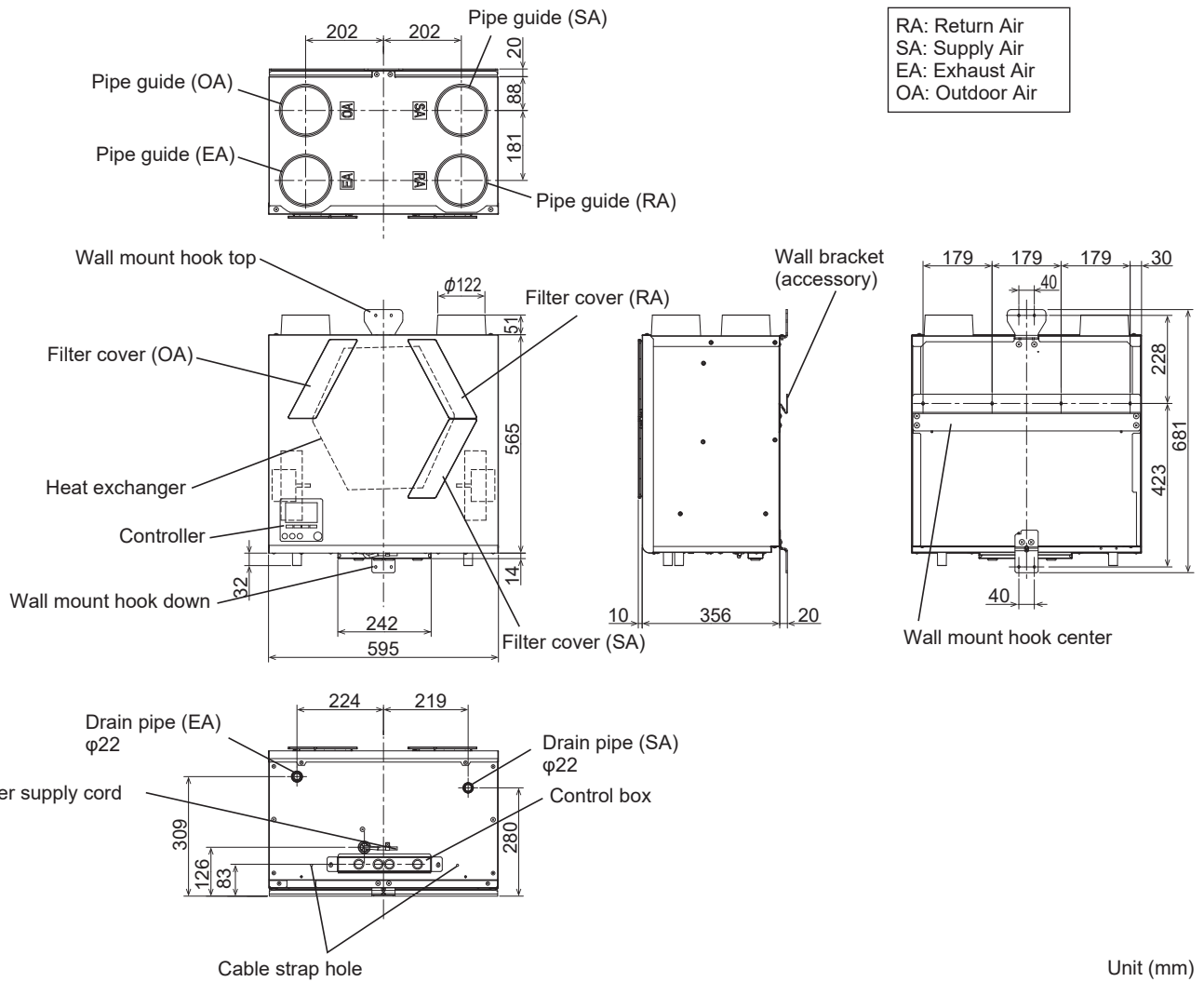

Wall bracket: 1 	Slim-Lossnay connection cable: 1 (100 mm) 	Drain hose fixture: 2 	Washer: 8 	Drain hose: 1 (250 mm) 	Cable strap: 1 
--	--	--	--	--	---

# VL-250CZPVU-L-E

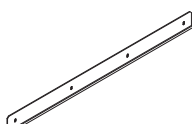

Unit (mm)

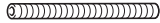
## Accessories

Wall bracket: 1 	Slim-Lossnay connection cable: 1 (100 mm) 	Drain hose fixture: 2 	Washer: 8 	Drain hose: 1 (250 mm) 	Cable strap: 1 
--	--	--	--	--	---





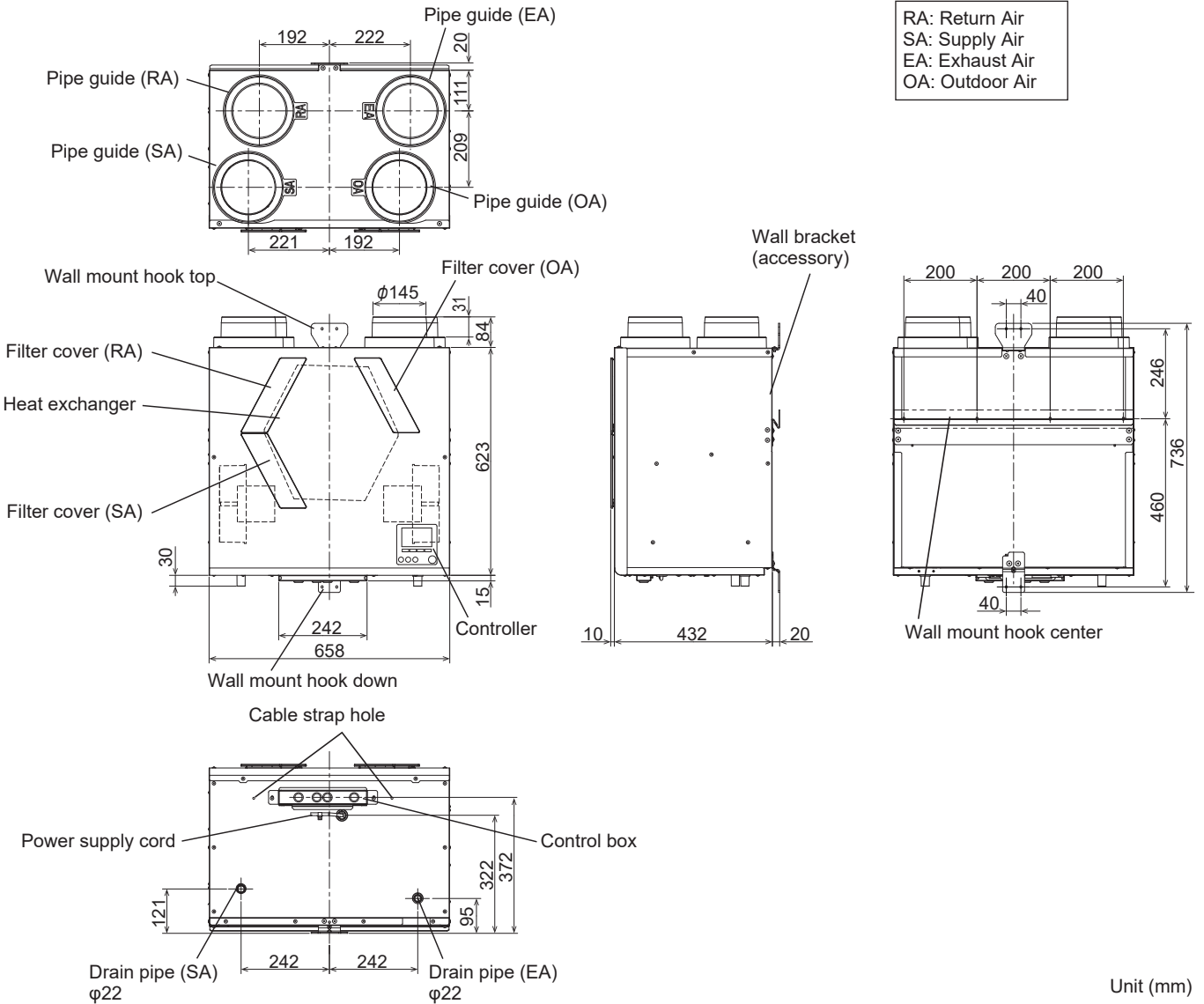

# VL-350CZPVU-R-E

RA: Return Air  
 SA: Supply Air  
 EA: Exhaust Air  
 OA: Outdoor Air

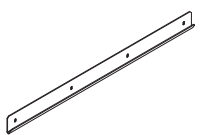

Unit (mm)

## Accessories





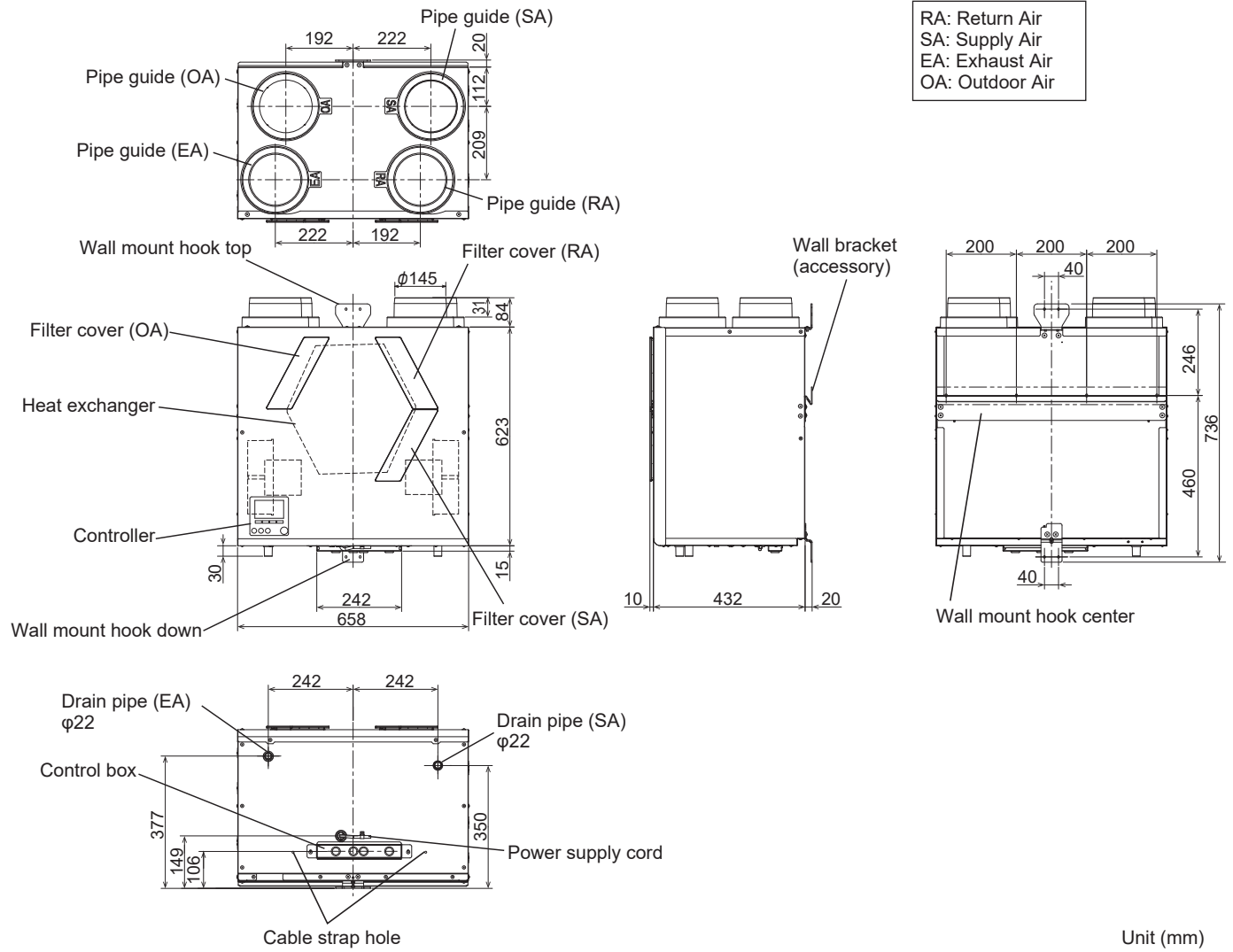

Wall bracket: 1 	Slim-Lossnay connection cable: 1 (100 mm) 	Drain hose fixture: 2 	Washer: 8 	Drain hose: 1 (250 mm) 	Cable strap: 1 
--	--	--	--	--	---

# VL-350CZPVU-L-E

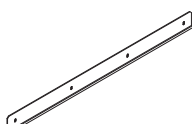

Unit (mm)

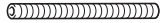
## Accessories

Wall bracket: 1 	Slim-Lossnay connection cable: 1 (100 mm) 	Drain hose fixture: 2 	Washer: 8 	Drain hose: 1 (250 mm) 	Cable strap: 1 
--	--	--	--	--	---

# 3. Standard Installation Example

## 3.1 Installation example

### Note

- Make sure that the exhaust air connection has two or more confluence points with the piping from the bathroom.
- Preheaters and electric dampers may be required in your region.
- Read the instructions carefully in advance when using optional components and commercially available components.

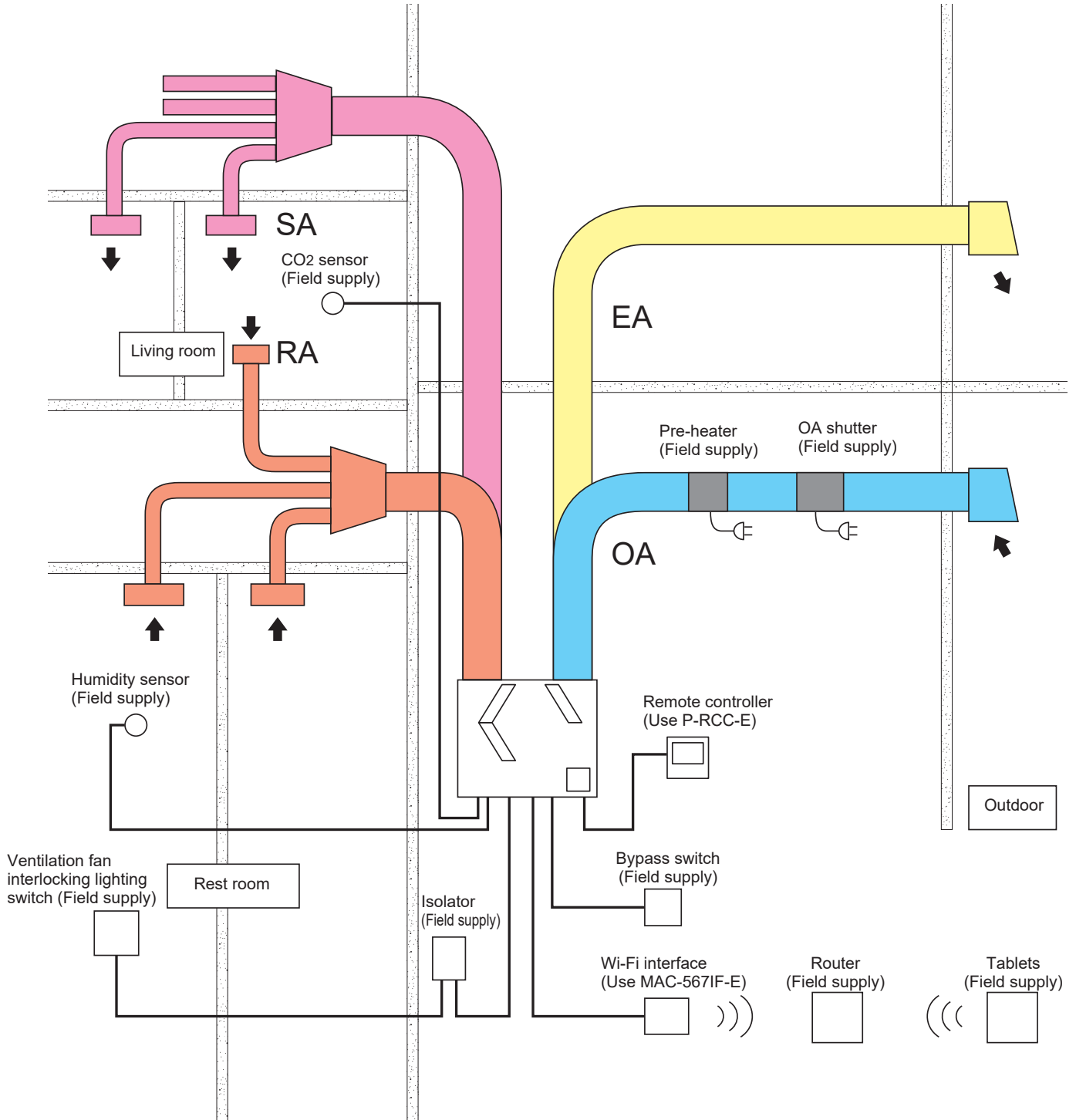

### 3.2 Working space (required space around the product)

This product requires regular maintenance (filter cleaning, parts replacement). Place the product from any other obstacles for maintenance.

#### ■VL-250CZPVU-R

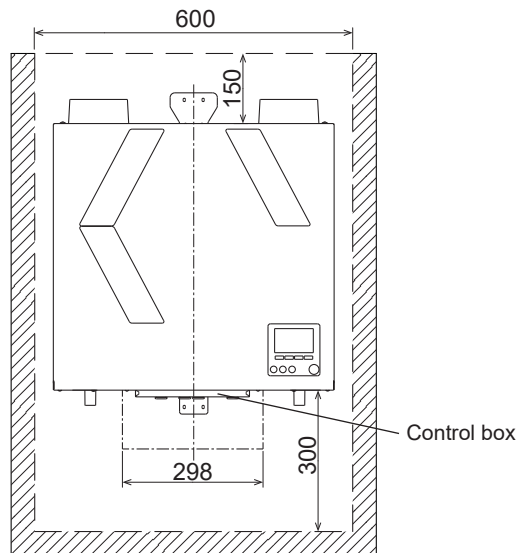
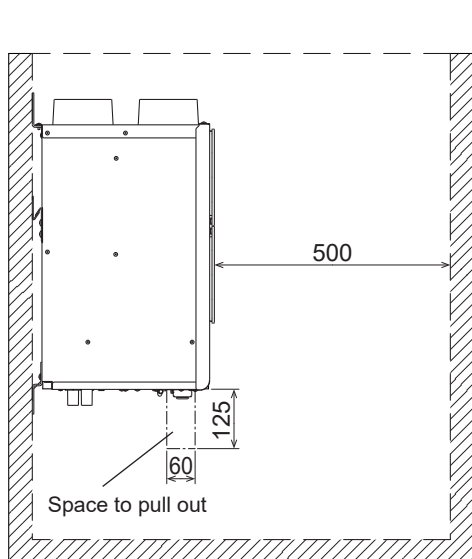

Unit (mm)

#### ■VL-250CZPVU-L

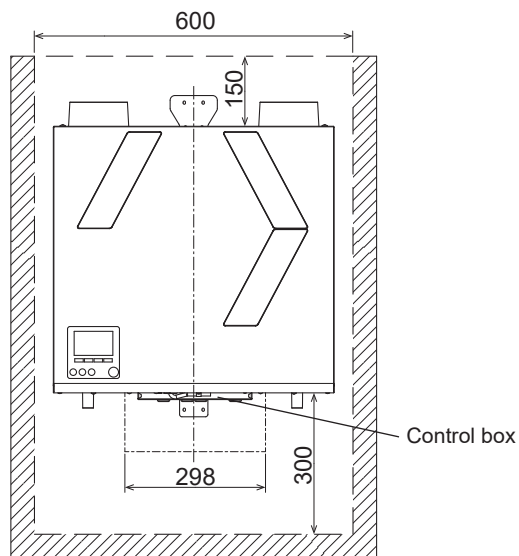
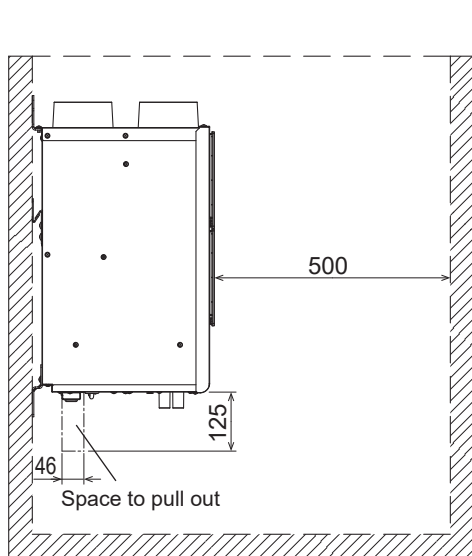

Unit (mm)

#### Note

- Secure about 2 mm of clearance from the side faces of the product to any other obstacles. (If not enough clearance is secured, maintenance cannot be performed. Plus, vibration can result.)
- Secure space below the product for withdrawing the control box. (If not enough space is secured, maintenance cannot be performed.)



■VL-350CZPVU-R

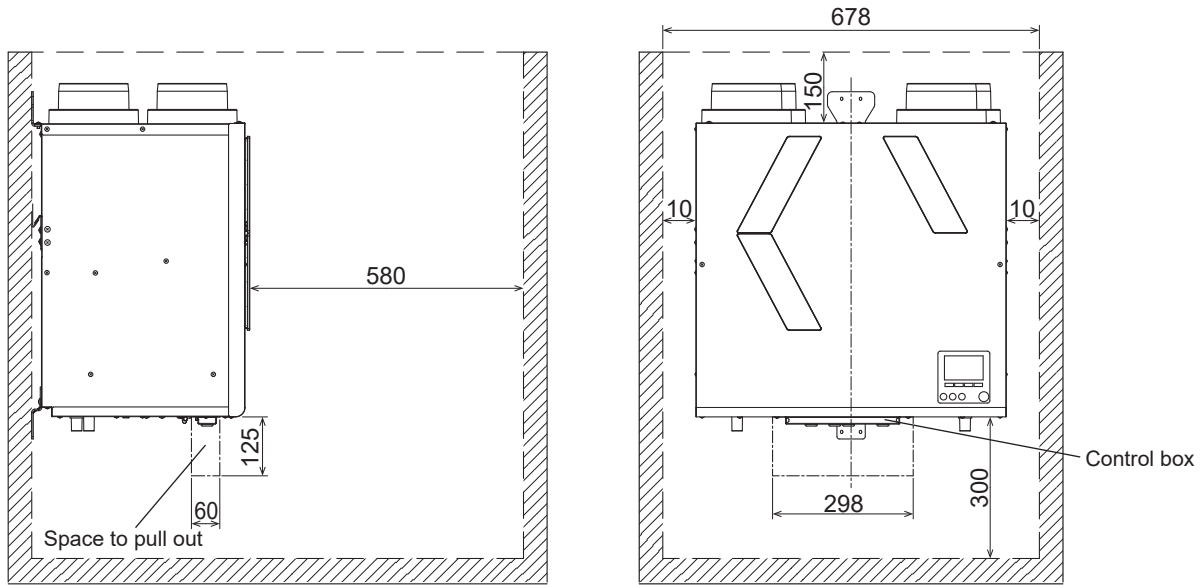

■VL-350CZPVU-L

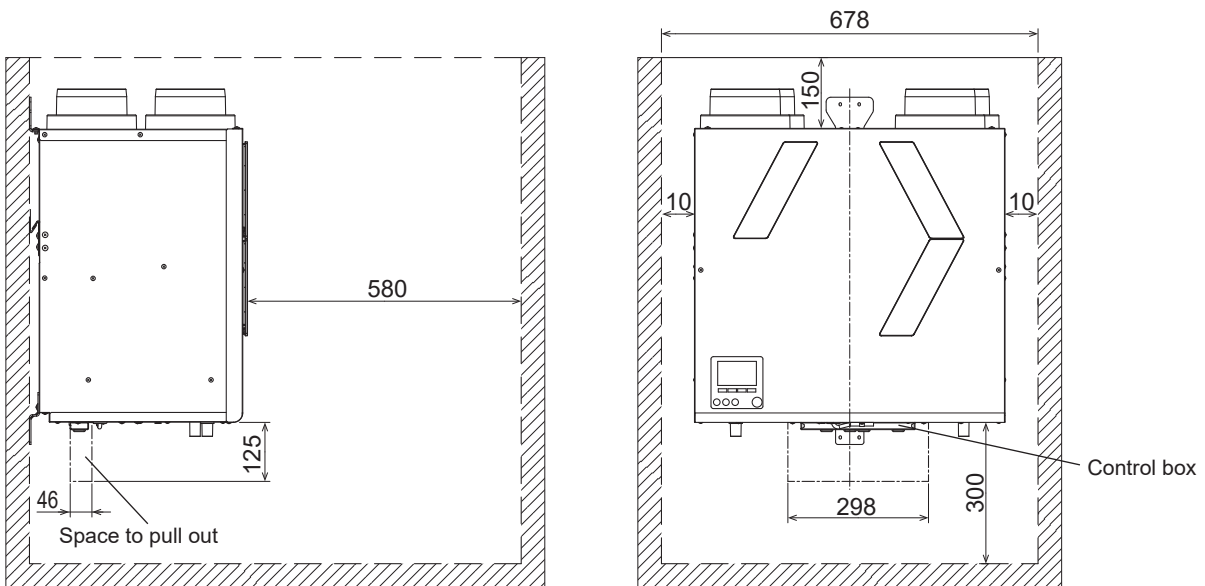

Unit (mm)

**Note**

- Secure about 10 mm of clearance from the side faces of the product to any other obstacles. (If not enough clearance is secured, maintenance cannot be performed. Plus, vibration can result.)
- Secure space below the product for withdrawing the control box. (If not enough space is secured, maintenance cannot be performed.)

# 4. Installation Procedure

## WARNING

Select a place which is strong enough to support the product, and install the product securely. Injury could result if parts fall.

## CAUTION

Install the product in the indoor side of the insulation layer/airtight layer.

When installed on the outdoor side of the heat insulating layer, the temperature of the heat-exchanged air will drop and condensation will form, which will cause the floor to get wet.

**The products should be attached to a vertical surface.**

The products may not be properly mounted and may cause deformation of the product.

**Transportation and installation of the product is carried out by two or more people.**

Cause of damage or injury of the product due to product fall.

**Wear gloves when installing.**

Failure to heed this warning may result in injury.

## Note

- The product is designed for wall mounting, only on a solid wall. (Wall strength is needed more than 250 kg/m<sup>2</sup>.)
- A gypsum block or stud/plasterboard wall will not suffice.

### 4.1 Wall bracket

One part of the wall bracket (Included) should be offered up to the wall, ensuring it's located horizontally. Make the fixing points through the pre drilled holes in the bracket and install with screws (normal diameter 4 mm), whilst ensuring the interlock side is at the top.

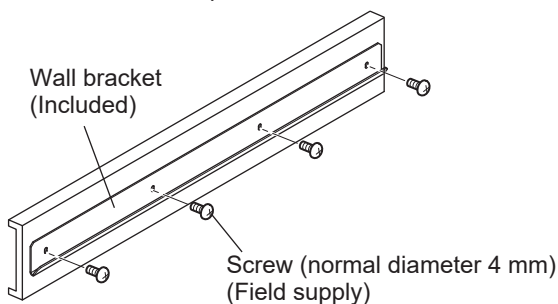

### 4.2 Mounting the Product

## CAUTION

**Do not carry with a pipe guide.**

Failure to heed this warning may result in damage to pipe guide.

**Do not place the product directly on the floor.**

Failure to heed this warning may result in damage to the drain pipe and the control box.

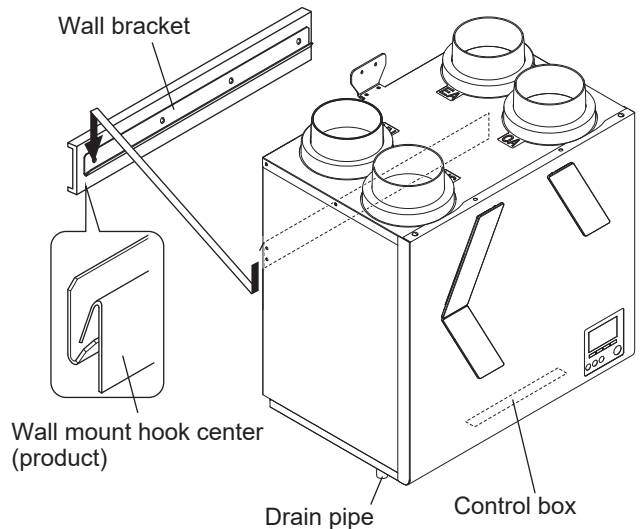

### 4.3 Fixing the Product

## CAUTION

**Install the product on the wall horizontally. (within  $\pm 1^\circ$ )**

Water leakage from the product may result in water damage to the floor.

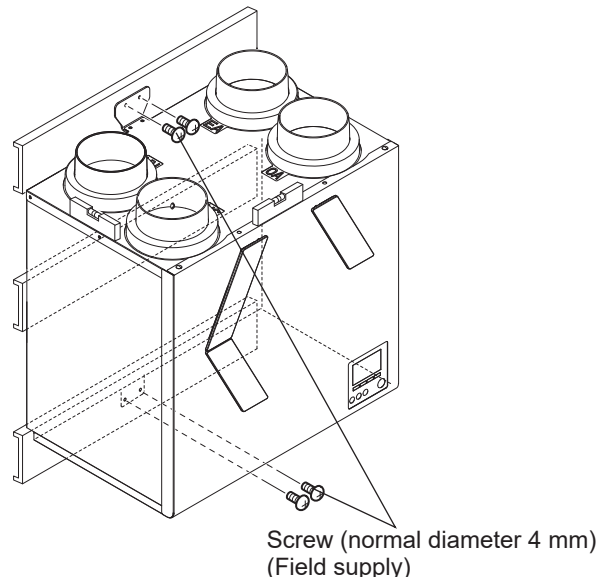

## Note

- Use a washer (Included), when there is a gap between the attached surface and the hooks.

## 4.4 Connecting Pipe

### 4.4.1 Piping Ducts

#### WARNING

Install the ducts in the indoor side of the insulation layer/ airtight layer.

When installed on the outdoor side of the heat insulating layer, the temperature of the heat-recovered air will drop and condensation will form, which will cause the floor to get wet.

**Secure duct piping with commercially available fixing bands, aluminum tape, etc. to prevent piping from loose. Install outdoor piping from the product so that it is tilted at a downward pitch of at least 1/30 towards the outside.**

Failure to heed this warning may cause rain penetration, resulting in electric shock/fire or water damage to household property.

#### Note

- When discharging the air from a bathroom, use ducts made of a material that does not allow water to leak.
- When using PVC ducts or metal ducts for the SA side ducts, make sure to connect ducts having silencer before the grill.
- The duct for exhaust from the bathroom and the pipe guide should be sealed with caulking material.
- When using caulking compound, take care to prevent it from oozing from the ducts. (Otherwise, it could cause aluminum tape to peel off.)
- Before connecting the ducts, make sure that there are no metal chips or other foreign matter (For example paper or vinyl) inside the ducts or inside the product.

#### ■VL-250CZPVU-R-E

#### ■VL-250CZPVU-L-E

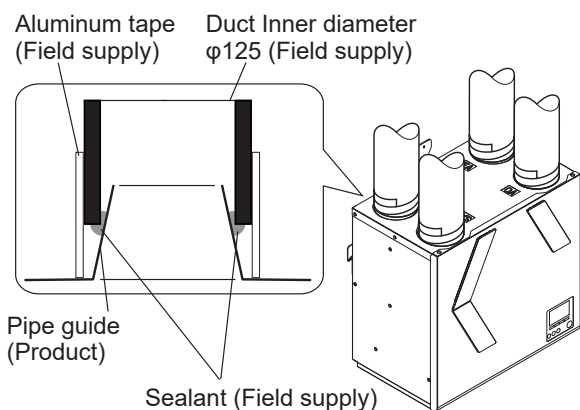

#### ■VL-350CZPVU-R-E

#### ■VL-350CZPVU-L-E

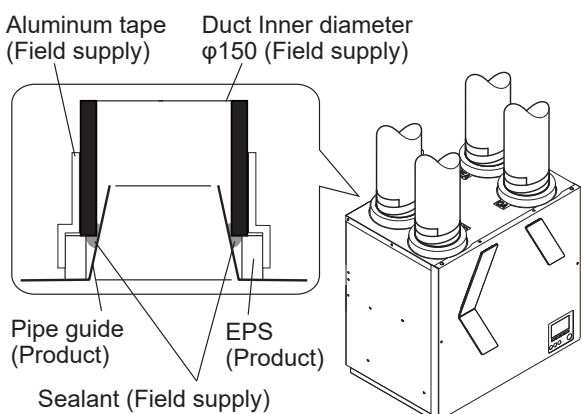

### 4.4.2 Insulating Ducts

#### CAUTION

To prevent dew condensation, insulate the ducts and pipe guide. (glass wool 25 mm or equivalent)  
Make sure to insulate up to the base of pipe guide.

When the product is anticipated to be stopped for a long time, insulate the RA (Return Air) side ducts also. (i.e. not operated for 24 hours).

Indoor humidity can cause condensation because exposed parts can become cold in winter.

#### ■VL-250CZPVU-R-E

#### ■VL-250CZPVU-L-E

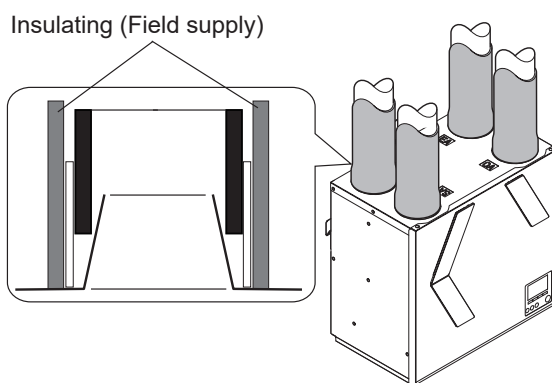

#### ■VL-350CZPVU-R-E

#### ■VL-350CZPVU-L-E

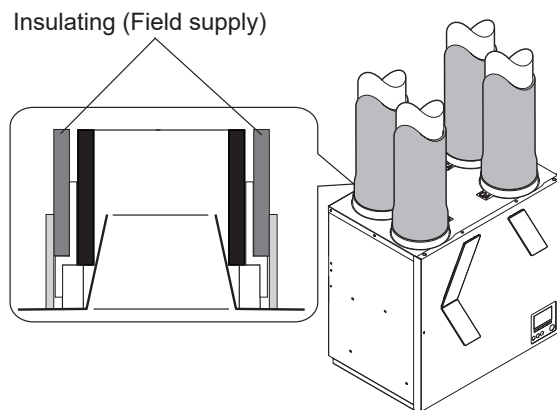

#### Note

- Attach insulation so that the aluminum tape is not exposed.

## 4.5 Connecting drain piping



### CAUTION

**Make sure to connect drain piping by the following procedure to prevent freezing and dew condensation forming on the surface of the piping**

- Connect the drain piping on the indoor side of the insulation layer

Insulate the drain piping up to the end of the piping

- Do not let the end of drain piping be immersed in the rain gutter, etc.

**(At times of heavy snow, the rain gutter freezes and drain water is not discharged, which results in water leaking from the product.)**

**This product has two drain pipes for EA and SA.**

EA means Exhaust Air side, SA means Supply Air side.

EA drain pipe : Piping required

SA drain pipe : Depend on temperature and humidity, see the following conditions.

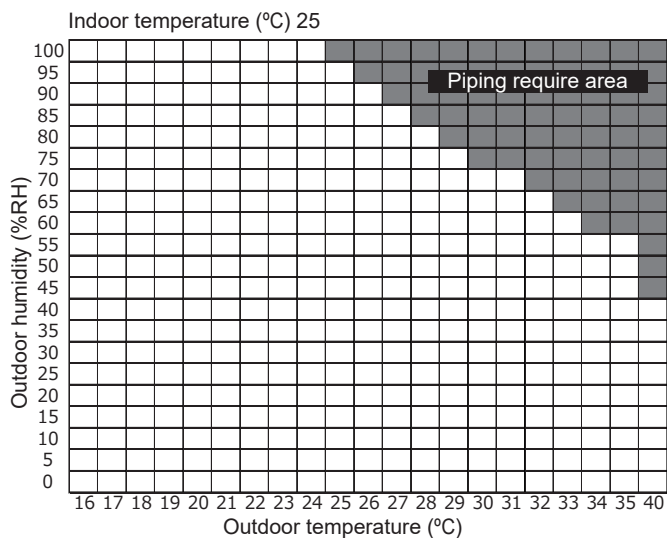
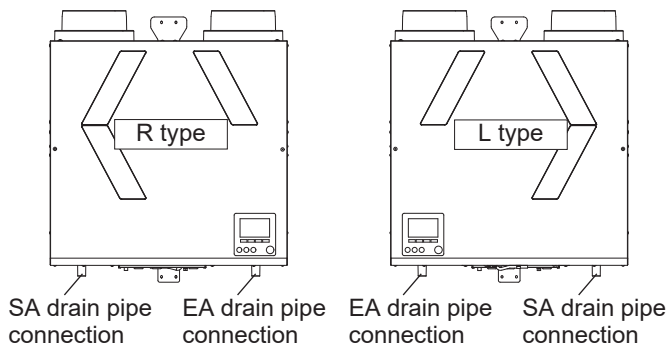

### 4.5.1 Connection method of drain hose (EA drain pipe)

- 1) Securely connect the accessory drain hose to the root of the connection port.  
Securely fix the accessory hose band by tightening with a flat head screwdriver. (Otherwise, water leakage can result.)
- 2) Connect one edge of the drain hose to the commercially available drain pipe (Drain pipe for building: hard PVC pipe (outside diameter:  $\phi 22$ )).  
Securely fix the accessory hose band by tightening with a flat head screwdriver.
- 3) Connect the drain pipe so that it has at least three degree of downward gradient from the lower part of the unit.  
(Otherwise, water leakage can result.)
- 4) Make sure to attach commercially available check valves.  
For how to use, follow their instructions. (If not used properly, water leakage can result.)

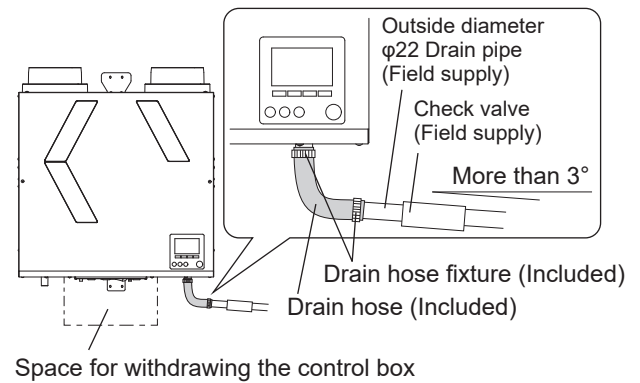

### Note

- Do not adhere drain hoses with drain connection ports.  
(Otherwise, maintenance cannot be performed.)
- Do not place the drain piping nearby the space for withdrawing the control box. (If the control box cannot be pulled out, product maintenance cannot be performed.)

### 4.5.2 Connection method of drain hose (SA drain pipe)

- 1) Extract the drain cap from the connection port of the SA drain. The cap is fix with tape.
- 2) Do the piping following the same procedures as the EA drain pipe.  
Drain hoses are not included; contact your dealer or contractor.

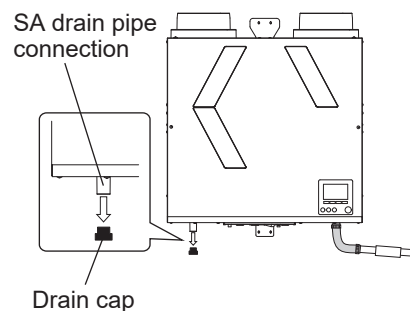

# 5. Electrical Work

## WARNING

Electrical work must be carried out safely and reliably by a professional electrical contractor (properly qualified electrician) in accordance with internal wiring provisions and electrical equipment technical standards.

Poor connection and faulty electrical work could result in electric shock or fire.

### Use 220 to 240 V AC power.

Failure to heed this warning may result in fire, electric shock or damage to the circuit boards.

### Make sure to install the ground wire.

In case of product failure and electric leakage, it may cause an electric shock.

## CAUTION

### A power supply isolator must be installed.

Install in a position where the isolator will not be wet by water from the power cord when condensation on the exterior surface of the product drops.

### Install an isolator in a position where the power cord can be replaced when damaged.

Otherwise, the power cord cannot be replaced.

If the supply cord is damaged, it must be replaced by the manufacturer, its service agent or similarly qualified persons in order to avoid a hazard.

Make sure to connect wiring properly according to the wiring diagram.

Misconnection may cause malfunction.

Please understand that expenses incurred in recovery work to deal with the above malfunction shall be borne by the contractor.

## 5.1 Standard use

### Power cord (product)

- LS (Black cord) means Live switch for kitchen and bath room. When you use LS, remove protective tube.

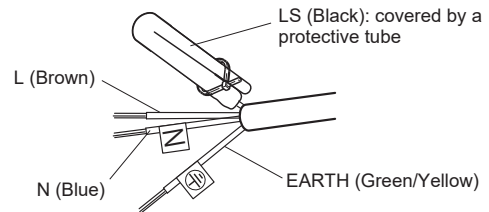

- Wiring example (for kitchen and bath switches)

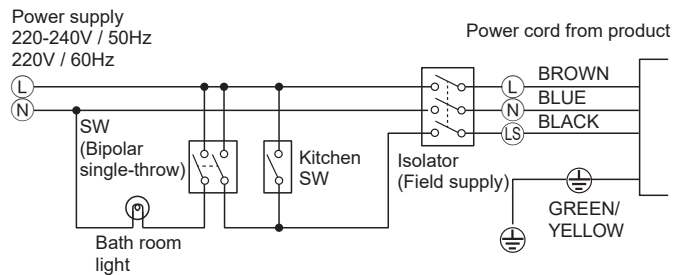

## CAUTION

Do not connect a load such as lighting to the live switch input.

It may cause product failure.

### Note

- When the switch is turned on, the circuit board secures 30 mA. If using the minimum load capacity of 10 mA, the maximum number of switches that can be used for the Live switch input is 3 pcs.
- Regarding the setting method of Boost(Purge) mode, see 6.4.5.3 Live switch. At the factory default settings, Live switch will not work just by connecting the LS.

## 5.2 External device connection use

Connect the each cable for external devices to control board according to the way below.

- 1) Remove 2 screws. Pull the control box. (It stops in the middle)

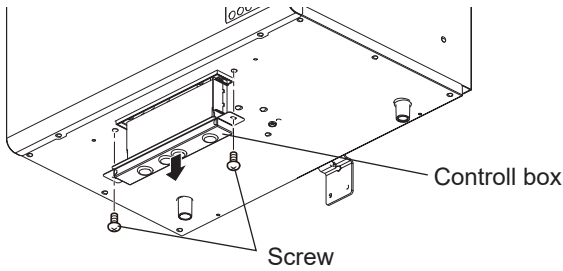

- 2) Remove an insulating sheet. (Be careful of the protrusions on both sides of the control box)

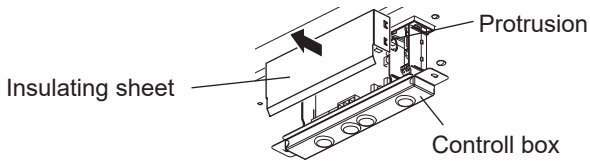

- 3) Connect the cables.

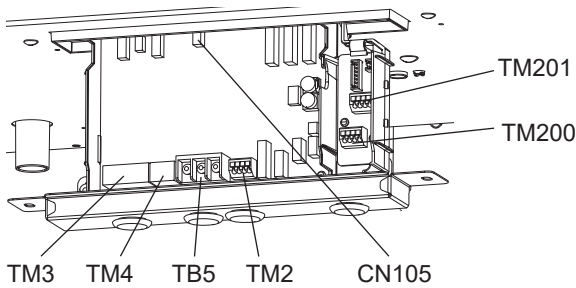

CN 105: IT interconnection Wi-Fi

TM200 1(+,-): Analog input 1 for Sensor 0-10V

2(+,-): Analog input 2 for Sensor 0-10V

TM201 ①-②: Volt-free contact for bypass switch

③-④: Volt-free contact for boost switch

TM2: Slim-Lossnay connection cable

TM3: Signal output

(Pre-heater, Malfunction, Operation monitor)

TM4: Operation the remote controller

Please use P-RCC-E (Optional cable)

TB5: Not in use

- 4) Make a cut in the Bush. Then pass the cord of the external device through the Bush.

Attach the insulating sheet on the control box.

Insert the control box to the product, attach two screws.

(Don't forget to place the insulating sheet)

Bind the external device wirings with a cable strap

(Included) and attach it under the product. (It is recommended to install it with flexibility so that it will not be loaded from the outside.)

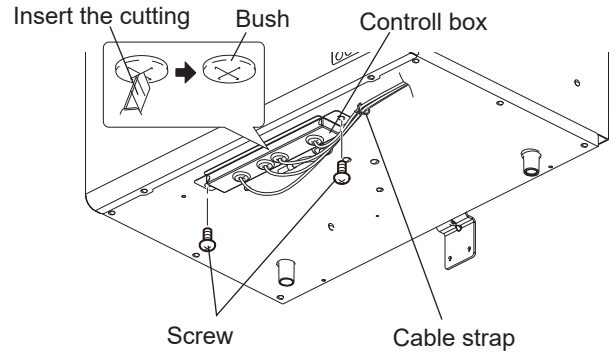

## 5.2.1 Diagram for control board

Control circuit board

Signal interface circuit board (VL-40S)

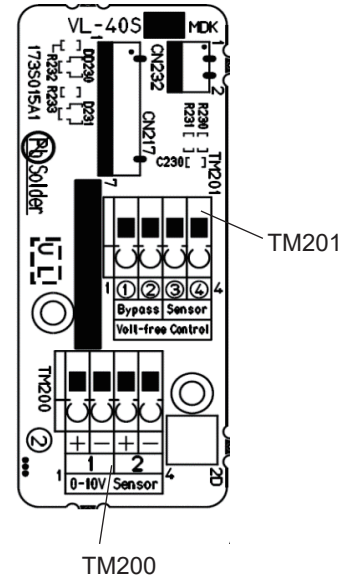
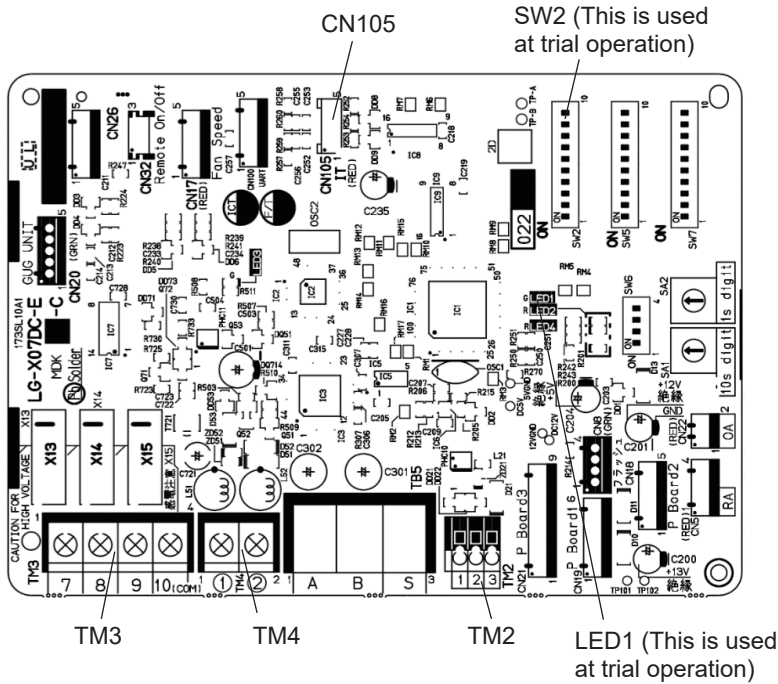

## 5.2.2 Terminal connection specifications and functions

Terminal	Category	No	Input/Output	Terminal rating	Selection requirement		Wiring example	Setting explanation
					Diameter and length of wires	Sensor, switch etc,		
TM200	1 + - Analog input (for sensor)	1	Input	Max: DC10 V Polarity	0.5 mm <sup>2</sup> - 0.75mm <sup>2</sup>	DC 0-10 V	fig 1	Section 6.4.5.2
	2 + - Analog input (for sensor)	2	Input					
TM201	① Volt-free contact (for bypass switch)		Input	No-Polarity	0.5 mm <sup>2</sup> - 0.75mm <sup>2</sup>	Contact rating: DC 15 V, 0.1 A Min. applicable load: 1 mA	fig 2	Section 6.4.5.4
	② Volt-free contact (for bypass switch)							
	③ Volt-free contact (for boost switch)							
TM2	1 Slim-Lossnay interlocking		Input	No-Polarity	0.5 mm <sup>2</sup> - 1.5mm <sup>2</sup> * See manual of external device (Slim).	—	fig 3	—
	2							
	3							
TM3	7 Volt-free contact signal for Bypass monitor or Preheater signal		—	Max: DC24V, 1A Min: DC5V, 0.1A No-Polarity	0.5 mm <sup>2</sup> - 0.75mm <sup>2</sup>	—	fig 4	Section 6.5.1
	8 Volt-free contact signal for Malfunction monitor or Outdoor shutter signal							
	9 Volt-free contact signal for Operation monitor (Exhaust fan, Supply fan, or After heater)							
	10 Common							
TM4	① Remote Controller		Input	No-Polarity	0.3 mm <sup>2</sup> Max. 200 m	—	fig 5	—
	②							
CN105	IT interconnection Wi-Fi		In/Out	—	—	—	fig 6	—





## WARNING

**Make sure to install safety devices that do not have self-return functions on the duct heaters (supply air preheaters, supply air after-heaters). Do not supply the duct heaters with electricity directly from the product.**

Failure to heed this warning may result in fire.

**When using duct heaters (supply air preheaters, supply air after-heaters) that do not have temperature control functions, select duct heaters that have the appropriate capacity according to the airflow passing through the heaters.**

Failure to heed this warning may result in fire because the heaters will overheat if the airflow is too little compared to the capacity of heaters.



## CAUTION

**Place the duct heaters (supply air preheaters, supply air after-heaters) at least 2 m from the product.**

Failure to heed this warning may cause damage on the product due to the preheating from the heaters.

### Note

- Select duct heaters (supply air preheaters, supply air after-heaters) based on the laws, regulations, and standards of the local government. Select duct heaters that have the CE marking.
- Install the earth leakage breakers of the duct heaters (supply air preheaters, supply air after-heaters) in line with the related laws, regulations, and standards.
- Do not use duct heaters (supply air preheaters, supply air after-heaters) outside the set air volume.
  - If the heater capacities are too large, the heaters may switch ON/OFF frequently.
  - If the heater capacities are too small, the air may not be heated.
- Make sure to check the operation at a commissioning after checking that the duct heaters (supply air preheaters, supply air after-heaters) and the product are electrically connected and that the product functions are set.
- If the ventilation mode is set to Auto while preheating functions are used on the duct heaters (supply air preheaters, supply air after-heaters), the operation may be set to the bypass ventilation operation.
- When the product is interlocked with air conditioners (Mr. Slim), the supply air operation and the output of the supply air preheaters are stopped while the air conditioners are defrosting.
- In the following cases, some Error code is displayed on the «Error information» screen.
  - And malfunction monitor signal is output.
  - OA thermistor detects higher than 15°C within 15 minutes after the heater output starts.
  - OA thermistor detects -10°C or lower, 60 minutes after the heater output starts.

fig 1

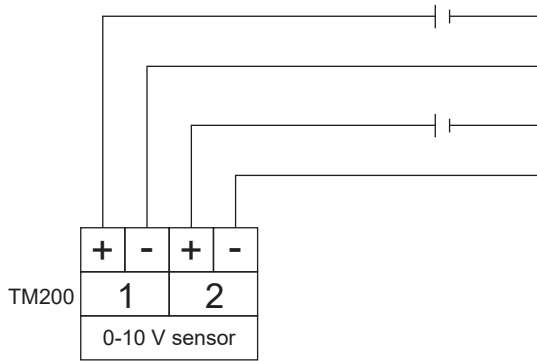

The unit can be operated by the DC power supply input from external devices.

**Note**

- Misconnection may cause malfunction of external device.
- Make sure to confirm the polarity.
- Make sure to connect electric wires correctly.
- Terminal block has a seal attached on No.2. When using No.2, remove the seal.

fig 2

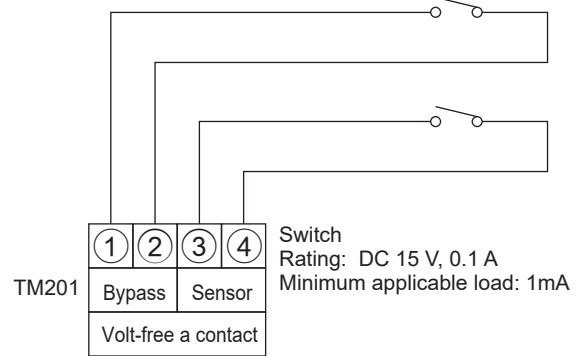

Switch  
Rating: DC 15 V, 0.1 A  
Minimum applicable load: 1mA

Volt-free a contact

Contact ON (closed) becomes input, and contact OFF (open) becomes OFF.

**Note**

- Since the circuit ensures 1 mA when the switch is turned on, the maximum number of switches that can be used for Volt-Free contact input is one when the minimum load capacity is 1 mA.

fig 3

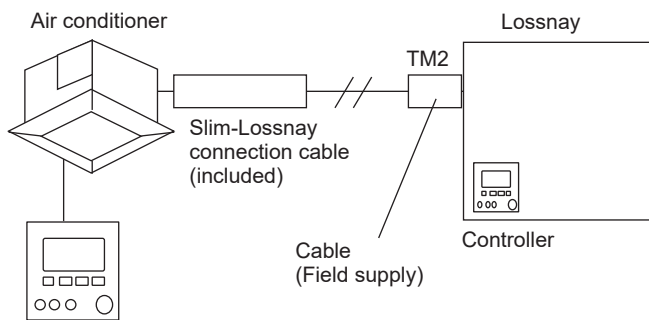

Mr. slim  
Controller

You can control the product by Mr.Slim's remote controller. Extend the Slim-Lossnay interlocking cable connected to Slim. Please attach to TM2 of the product. When interlocked with Mr. Slim, signals from Mr. Slim operate/stop Lossnay. (The product stops regardless of the Enable off button setting.)

**Note**

- Make sure to check the setting of Mr. Slim in line with the following.
- At the selection of the remote controller functions of Mr. Slim, check that the Lossnay connectivity setting is set to Not supported.
- This use method limits the function as below.
  - Other external input functions cannot be used together.
  - Interlocking commands from Mr. Slim do not operate the boost/purge modes.

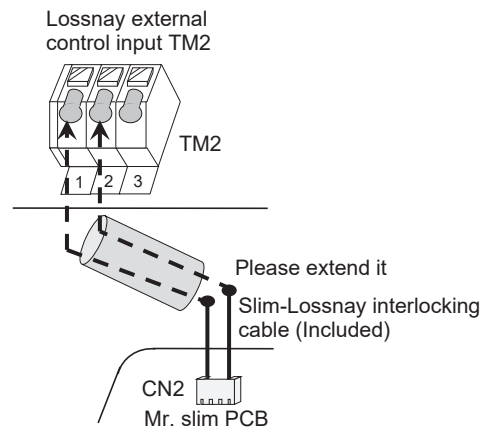
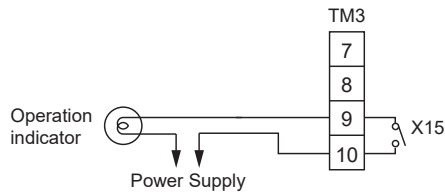

fig 4

**<Examples of electric wiring for function setting No.57 TM3 9-10>**

Function setting value [1]: Exhaust air fan  
 Function setting value [2]: Supply air fan



Function setting value [3]: Supply air after-heater

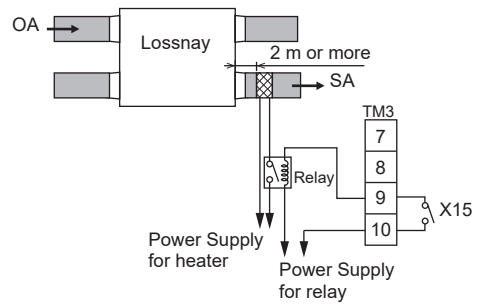

**<Examples of electric wiring for function setting No.58 TM3 7-10>**

Function setting value [1]: Bypass ventilation

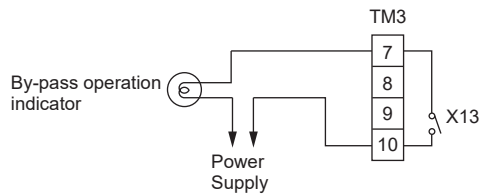

Function setting value [2]: Supply air preheater

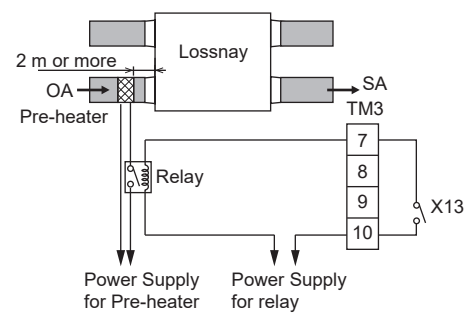

**<Examples of electric wiring for function setting No.81 TM3 8-10>**

Function setting value [0]: Malfunction monitor

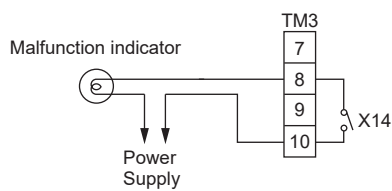

Function setting value [1]: Outdoor air shutter

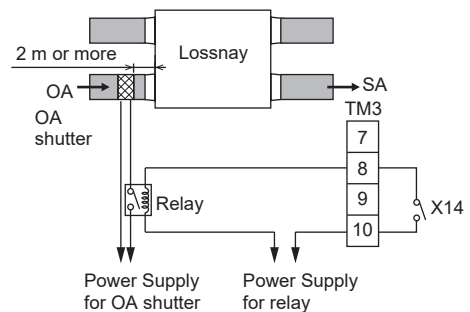
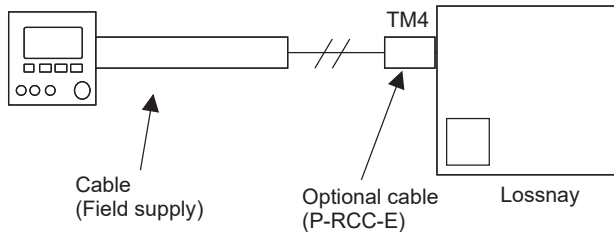

fig 5

Remote controller



**Note**

- Use the controller installed on the product. Install the remote controller with extension cables in line with the manual attached to P-RCC-E. The product cannot be controlled by multiple remote controllers.

fig 6

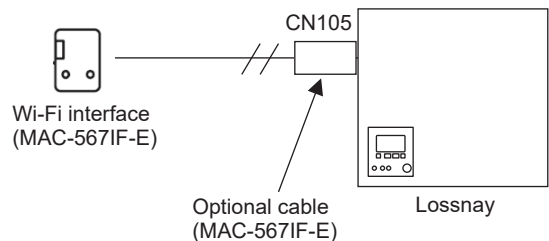

**Note**

- Application is not included; Contact your dealer or contractor.

## ■ Post-installation Checks

When you have finished installation work, inspect the following items according to the following Check list before turning the power on.

Make sure to correct any malfunctions that are found. (The functions is not being demonstrated or safety can not be ensured)

	Check Item	Remedy for Malfunction	Check
Installation of the product	Are the product and the duct piping installed on the indoor side of the insulation layer/airtight layer?	Install them on the indoor side of the insulation layer/airtight layer.	
	Is the product installed within $\pm 1^\circ$ of the horizontal?	Install within $\pm 1^\circ$ of the horizontal	
	Is sufficient work space ensured? * See 3.2 <i>Working space (required space around product)</i> at <b>3. Standard Installation Examples.</b>	Ensure the required work space	
Duct connections	Is the outdoor side duct installed tilted 1/30 or more towards the outside to prevent rain water from entering?	Install the duct tilted	
	Are there metal chips or other foreign matter (for example paper or vinyl) inside the product or the ducts?	Remove any foreign matter.	
	Are ducts insulated down to their base? * See <i>Duct piping/ 2. Insulating</i> at <b>4. Installation Procedure.</b>	Insulate	
	Are ducts connected to the product? (Air leakage causes dew condensation.)	Securely connect the ducts	
Drain piping	Is the drain piping connected on the indoor side of the insulation layer?	Connect the drain piping on the indoor side of the insulation layer	
	Is the drain piping insulated up to its end?	Insulate up to the end of the drain piping	
	Is the end of the drain piping inside the rain gutter?	It is not inside the rain gutter	
	Is the end opening facing down vertically in a condition to drain water well?	Make the opening face down so that water drains well	
Wiring	Is the power supply voltage correct?	Use 220 to 240 V power supply.	
	Is the wiring work the same as wiring diagram?	Wire as shown in the wiring diagram	
	Is the ground wire connected to the screw certainly?	Securely connect the ground wire	

# 6. How to use Controller

## 6.1 Controller button functions

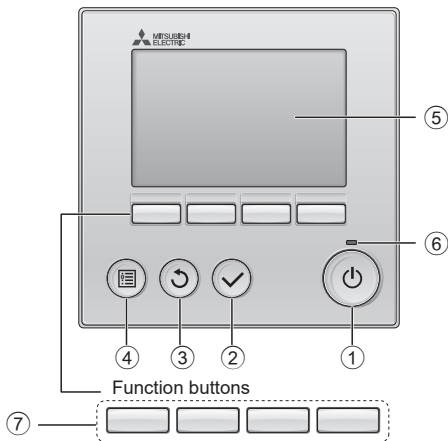

① **ON/OFF button**  
Off operation is disabled at the factory default setting.  
Please see 6.4.2.7 Control mode.

② **SELECT button**

③ **RETURN button**

④ **MENU button**

The «Main menu» screen is displayed.  
Please see 6.2 Menu structure.

⑤ **Backlit LCD**

The screen displays operation settings.  
Press any button to turn on the backlight.  
You will be able to operate buttons.

After turning on the backlight for a certain period of time,  
the backlight turns off.

⑥ **ON/OFF lamp**

The lamp lights up in green while the product is  
operated. It blinks in green, while the product has an  
error.

⑦ **Function buttons (F1, F2, F3, F4)**

Use to select each settings on each screen.

The functions of the buttons change depending on the  
screen.

See the function button guide at the bottom of the  
screen.

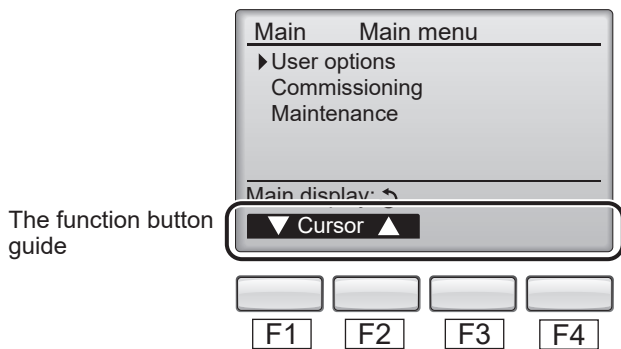

The function button  
guide

### Note

- If the function is not set in the function button , the function button guide will not be displayed.

## 6.2 Menu structure

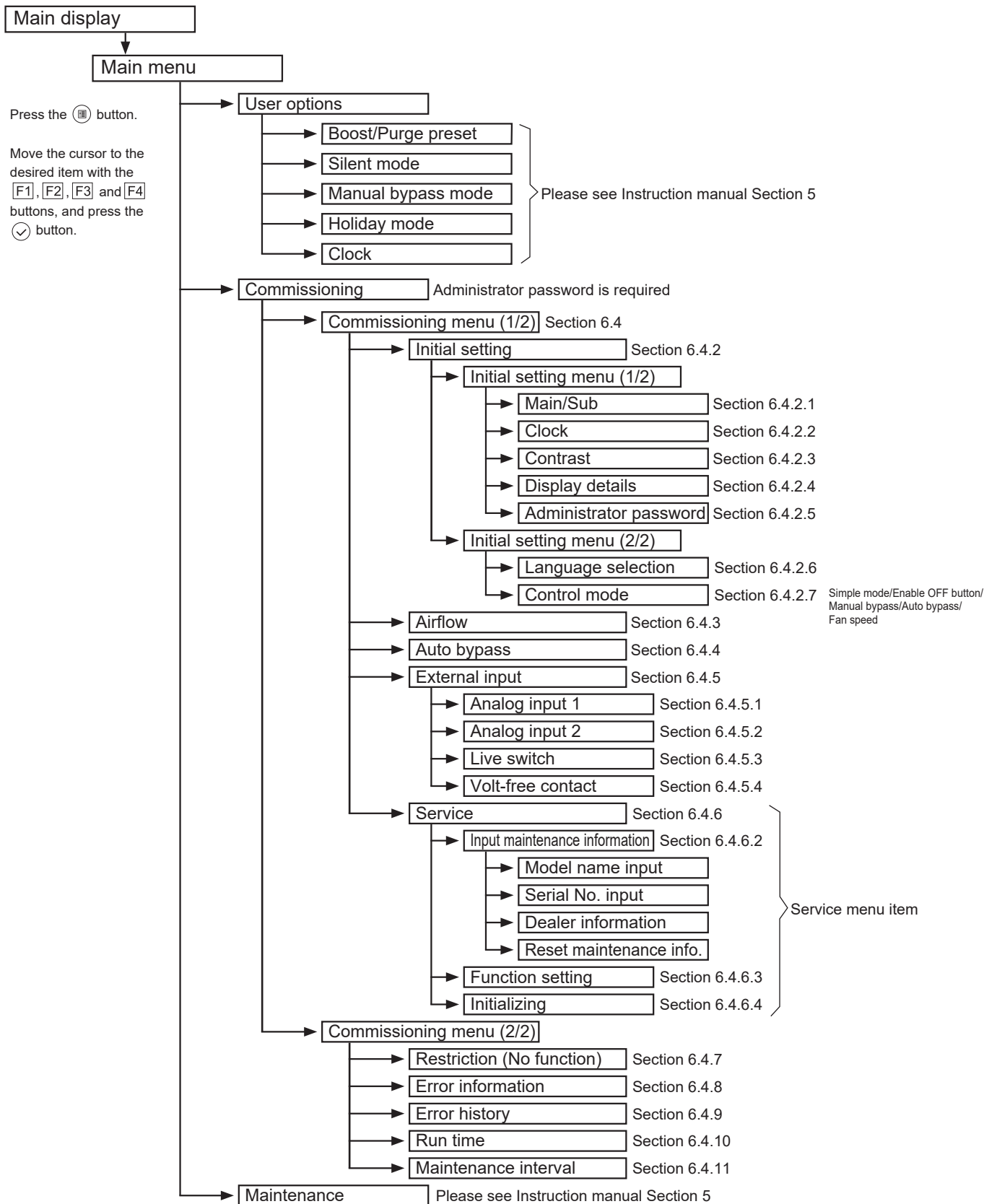

### Navigating through the screens

- To go back to the «Main menu» screen .....
- To return to the previous screen .....

### Note

- If no buttons are touched for 10 minutes (Air flow and Service menu item: 2 hours), the screen will automatically return to the «Main display» screen.
- Any settings that have not been saved will be lost.

## 6.3 «Main menu» screen and operation

### 6.3.1 Turning on the power

Before turning on the power:

- 1) Make sure that the connection is properly installed according to the Installation Manual.
- 2) Make sure that the product has been installed completely.

### 6.3.2 When the power is supplied, the screen below will appear.

Normal start up (indicating the percentage of process completion)

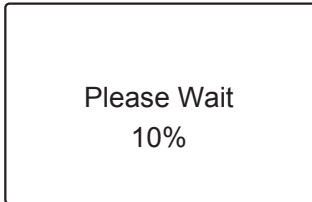

**Note**

- Only the first time, the «Language selection» screen will be appeared.
- The product will not start-up without language selection.
- See 6.4.2.6 Language selection.

### 6.3.3 Main display

After the successful startup, the «Main display» will appear.

The product is not in operation.

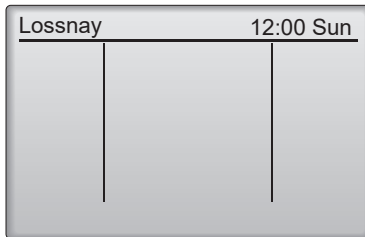

The product is in operation.

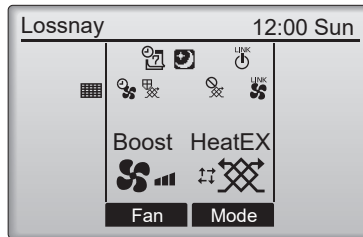

### 6.3.4 Main menu

Press the button, this screen appear.

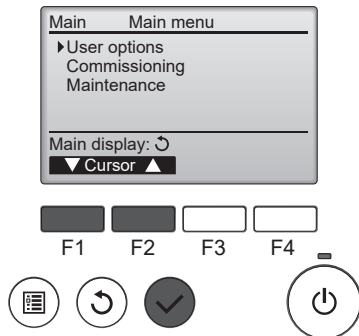

Press the button to move the cursor.

Press the button to go to the next screen.

## 6.4 Commissioning menu

- You can use Commissioning menu.

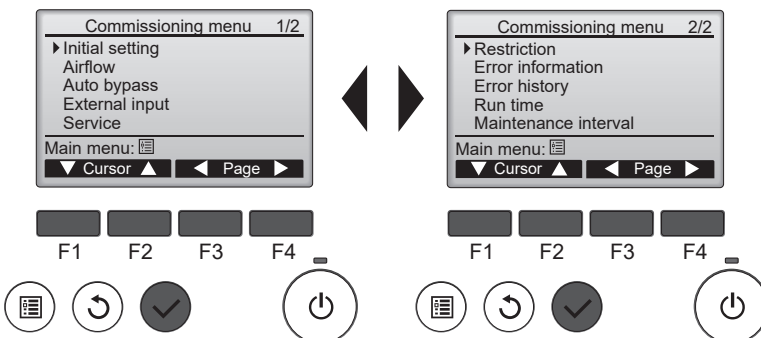

Press the button to move the cursor.

Press the button to go to the next screen.

- Administrator password is required. See 6.4.1 Administrator password.



### 6.4.1 Administrator password <Administrator password is required.>



Press the [F1], [F2] button to move the cursor.

Press the [F3], [F4] button to change the number.

Press the [✓] button to set the password.

#### Note

- The administrator password is required to set the items under «Commissioning menu».
- Factory default password is 9999.
- 6.4.2.5 Administrator password setting to change your password.

### 6.4.2 Initial setting menu

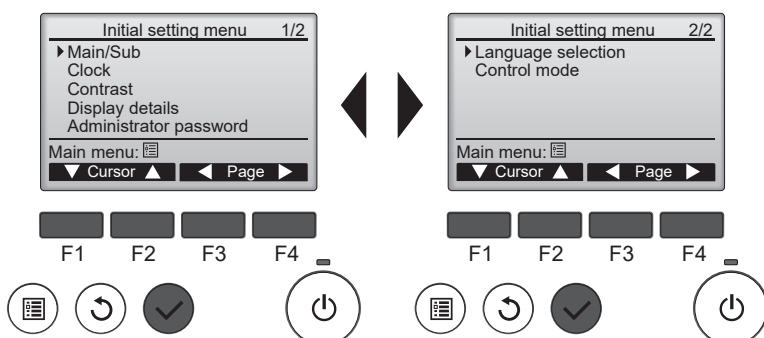

Press the [F1], [F2], [F3], [F4] button to move the cursor.

Press the [✓] button to go to the next screen.

#### 6.4.2.1 Main/Sub

The product does not have this function. Press the [↶] button to go back to the «Initial setting menu» screen.

#### 6.4.2.2 Clock

You can set Clock *year, month, day, hour, minute*.

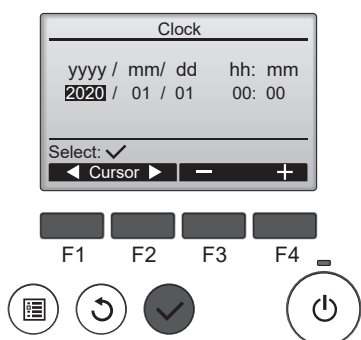

Press the [F1], [F2] button to move the cursor.

Press the [F3], [F4] button to change the value.

Press the [✓] button to save the changes.

#### Note

- Clock setting is necessary for setting the time, the Silent mode, the Holiday mode, the Manual bypass mode and the Error history. Make sure to perform clock setting when the product is used for the first.

### 6.4.2.3 Contrast

You can set Contrast of the screen.

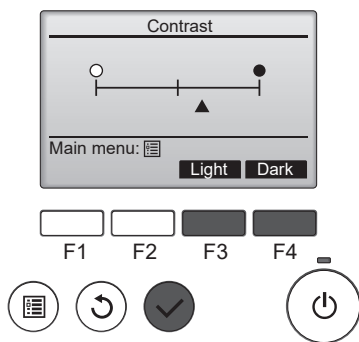

Press the **[F3]** button to adjust the contrast.

Press the **[✓]** button to save the changes.

#### Note

- Adjust the contrast to improve viewing in different lighting conditions or different installation locations. This setting does not always improve the display from all directions.

### 6.4.2.4 Display details

You can change the display details about clock and temperature, sensor value.

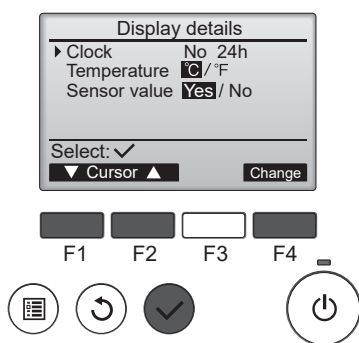

Press the **[F1]**, **[F2]** button to move the cursor.

Press the **[F4]** button to change the setting.

Press the **[✓]** button to save the changes.

[Clock]: See 6.4.2.4 Clock display

[Temperature]: Change the temperature display [Celsius (°C)/ Fahrenheit (°F)]

The factory default setting: °C

[Sensor value]: Change [Display (Yes)/Hide (No)] the sensor value on the «Main display» screen.  
The factory default setting: *No*

#### Note

- Sensor value includes [Outdoor temperature], [Return temperature], [Supply temperature], [CO<sub>2</sub> concentration].
- To display the [Sensor value] on the «Main display» screen, change the [Function setting] (See 6.4.6.3, 6.5), [External input] ([CO<sub>2</sub> concentration] display only, see 6.4.5) setting in addition to the setting.
- The outdoor and return temperatures are detected by the thermometer of the product.
- A CO<sub>2</sub> sensor must be connected display the [CO<sub>2</sub> concentration].
- The supply temperature is calculated based on the standard heat-exchange efficiency.
- The values will differ from the actual outdoor, return, supply temperatures, and CO<sub>2</sub> concentration.

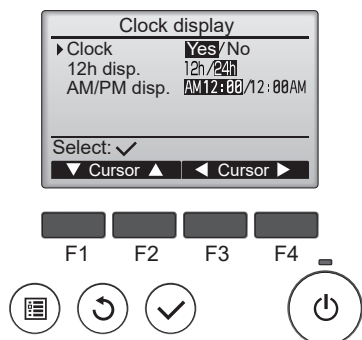

### Clock display

[Clock]: Change [Display (Yes)/Hide (No)] the time on the «Main display» screen.

The factory default setting: Yes

[12h disp.]: Change the time display [12 hour (12h)/24 hour (24h)] on the «Main display» screen.

The factory default setting: 24h

[AM/PM disp.]: Only selecting [12h disp.].

Change [AM/PM] display position.

The factory default setting: AM 12:00

- Time display format will also be reflected on the timer and schedule setting display. The time is displayed as shown below.

12-hour format: AM12:00 ~ AM1:00 ~ PM12:00 ~ PM1:00 ~ PM11:59

### 6.4.2.5 Administrator password setting

You can set the administrator password.

① Press the [F1], [F2], [F3], [F4] button to enter the current password.

Press the [Confirm] button to go to the next screen.



② Press the [F1], [F2], [F3], [F4] button to enter the new password.

Press the [Confirm] button to go to the next screen.



③ Press the [F4] button to update the new password.



### Note

- To prevent unauthorized access, change the default password. Have the password available for those who need it.

### 6.4.2.6 Language selection

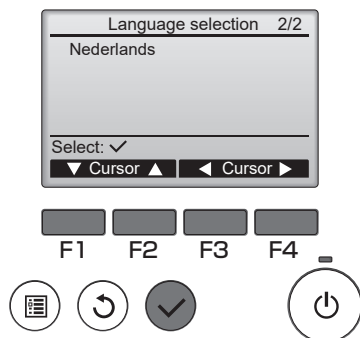

Press the [F1], [F2], [F3], [F4] button to move the cursor.

Press the [Confirm] button to save the language.

### 6.4.2.7 Control mode

Setting Fan speed, ventilation mode icon and limitation of function.

#### Note

- «Control mode» screen cannot be go to when the product is in operation. Press the  button on the «Initial setting» screen to stop the operation.

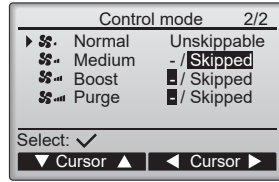
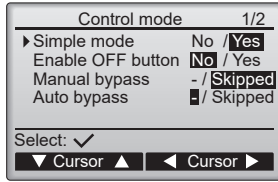







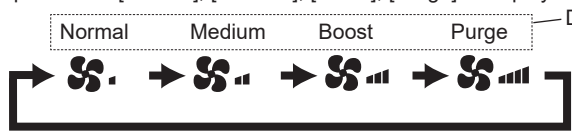
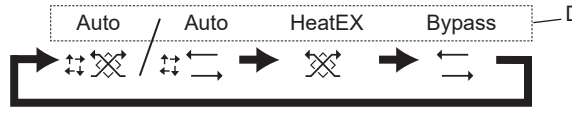

Press the **[F1]**, **[F2]** button to move the cursor.

Press the **[F3]**, **[F4]** button to change the setting.

Press the  button to save the changes.

The contents of setting items are as follows

Setting item	Base setting		Remarks
Simple mode	Yes (Factory default setting)	No	<p>Select [Yes] Fan speed icon: [Normal], [Medium], [Boost], [Purge] is displayed.</p>  <p>Ventilation mode icon: [Auto], [HeatEX], [Bypass] is displayed.</p>  <div style="border: 1px solid black; padding: 5px; margin-top: 10px;"> <p><b>Note</b></p> <ul style="list-style-type: none"> <li>- Make sure to select first [Yes/ No] (Simple mode).</li> <li>- If you change Yes/No, the settings of [Enable OFF button], [Manual bypass], [Auto bypass], and [Fan speed] will return to the Base settings.</li> </ul> </div>
Enable OFF button	No	Yes	<p>Select [Yes] to enable the [OFF function] of the .</p> <p>When you want the product to stop operating with the [Yes] setting, use an isolator.</p> <div style="border: 1px solid black; padding: 5px; margin-top: 10px;"> <p><b>Note</b></p> <ul style="list-style-type: none"> <li>- Except for the screen below, the [OFF function] is valid regardless of the setting of [Enable OFF button]. «Main display», «Main menu», «User options», «Boost/Purge preset», «Silent mode», «Manual bypass mode», «Holiday mode», «Clock», «Maintenance».</li> </ul> </div>
Manual bypass	Skipped	—	<p>Select [Skipped] to set the ventilation mode [Manual bypass operation (  )] to skip.</p> <p>When you want to use [Manual bypass operation] with the [Skipped] setting. Use the Manual bypass function.</p>
Auto bypass	—	—	<p>Select [Skipped] to set the ventilation mode [Auto bypass operation (  )] to skip.</p>
Fan speed	 Unskippable  Skipped  —  —	— Unskippable — —	<p>Select [Skipped] to set the Fan speed to skip.</p> <p>Base notch is [Unskippable].</p>

### 6.4.3 Air flow

Adjust the output of the fan speed.

#### Note

- Make sure to set the Airflow settings for all fan speeds to be used and measure the air volumes. The output of the notch whose fan speed has been changed from the factory default setting is different from the output of the notch whose fan speed has not been changed. For example, the fan outputs are different under the same 70% settings. (For 65% of **SS** whose fan output was changed from the factory default setting and 70% of **SS** whose fan output was not changed, the output of the latter can be lower than the former one.)
- Make sure to set the fan speed after making the supply air volume and the exhaust air volume equal. If there is a large difference in the supply and exhaust air volumes, the product protection function for winter may not operate properly.

#### 6.4.3.1 Accessing the «Airflow» screen

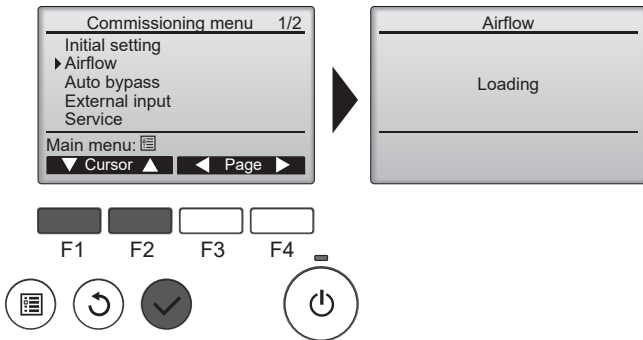

Press the **F1** and **F2** button to move the cursor.  
Press the button to go to the next screen.

The product data is loaded before the screen will appear. [Loading] is displayed. (10-60 seconds)

#### 6.4.3.2 Fan speed selection

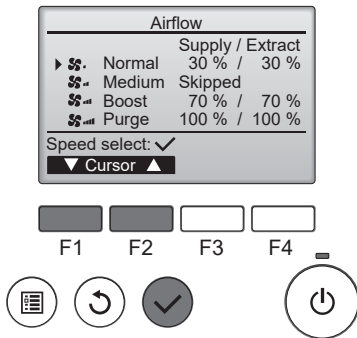

Press the **F1** and **F2** button to move the cursor.  
Press the button to select a fan speed.

The fan speed set to Skipped on the «Control mode» screen will show Skipped and the Airflow cannot be set.

#### 6.4.3.3 Adjust the supply air fan output/exhaust air fan output of the fan speeds

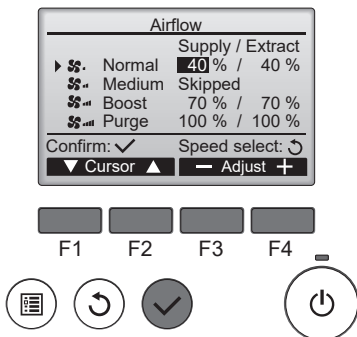

Press the **F1** and **F2** button to move the cursor.  
Press the **F3** and **F4** button to change the fan output. (Pressing and holding the button will increase the changing speed.)  
Press the button to set the fan output.

#### Note

- Press the button after changing the output of one fan speed to perform 6.4.3.4 Adjust the fan output of the product. (You can only change either supply or exhaust air speed output per one time.)

### 6.4.3.4 Adjust the fan output of the product

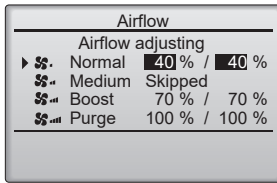

The product starts adjusting the fan output.

[Airflow adjusting] is displayed.

After completing the output adjustment of the fan on the product, it returns to the screen of 6.4.3.3.

#### Note

- Measure the air volume after Airflow adjusting has disappeared.

If readjustment is needed for the output of the same fan speed, repeat 6.4.3.3-6.4.3.4.

### 6.4.3.5 Output settings for other fan speeds

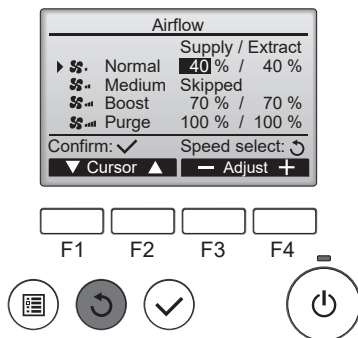

Press the button to return to 6.4.3.2 Fan speed selection.

Select other fan speed at 6.4.3.2.

Reperform 6.4.3.3-6.4.3.4

#### Note

- The fan speed icons below indicate the level of air volume. Make sure to set the product so that the output of the fan speed and the indication of the icon are the same.

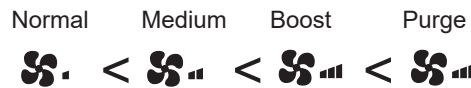

### 6.4.3.6 Saving the settings

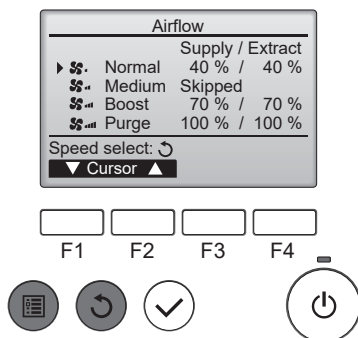

Press the button to return to 6.4.3.2 Fan speed selection.

When the or button is pressed at 6.4.3.2 Fan speed selection, the setting is saved and the «Commissioning menu» or «Main menu» screen is displayed.

#### Note

- Make sure to set the Airflow settings for all fan speeds to be used and measure the air volumes. If not performed, the outputs of the fan speeds and the indications of the icons may not be the same.

### 6.4.4 Auto bypass

In the Auto bypass mode, the product decides to operate heat exchange ventilation/bypass ventilation every 30 minutes. On the «Auto bypass» screen, set the threshold of the switching map for heat exchange ventilation/bypass ventilation. Outdoor temperature, indoor temperature, and their temperature difference can be set as the threshold.

[Outdoor temp. low limit]: The lowest limit of outdoor temperature in the bypass ventilation area  
The factory default setting: 16°C / Setting range: 10 to 25°C

[Target indoor temp.]: The lowest limit of indoor temperature in the bypass ventilation area  
The factory default setting: 16°C / Setting range: 15 to 30°C

[Outdoor temp. cooler by]: The upper limit of temperature difference between indoor temperature and outdoor temperature  
The factory default setting: 0K / Setting range: 0 to 7K

#### Note

- When °C/°F is switched on 6.4.2.4 «Display details» screen, the indications of the [Outdoor temp. low limit] and the [Target indoor temp.] will be switched. The table shows the changed values.

↓ The factory default setting

°C	10	11	12	13	14	15	16	17	18	19	20	21	22	23	24	25	26	27	28	29	30
°F	50	52	54	55	57	59	61	63	64	66	68	70	72	73	75	77	79	81	82	84	86

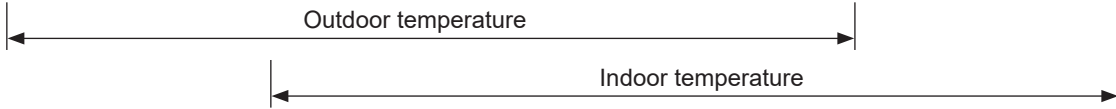

Setting reference example)

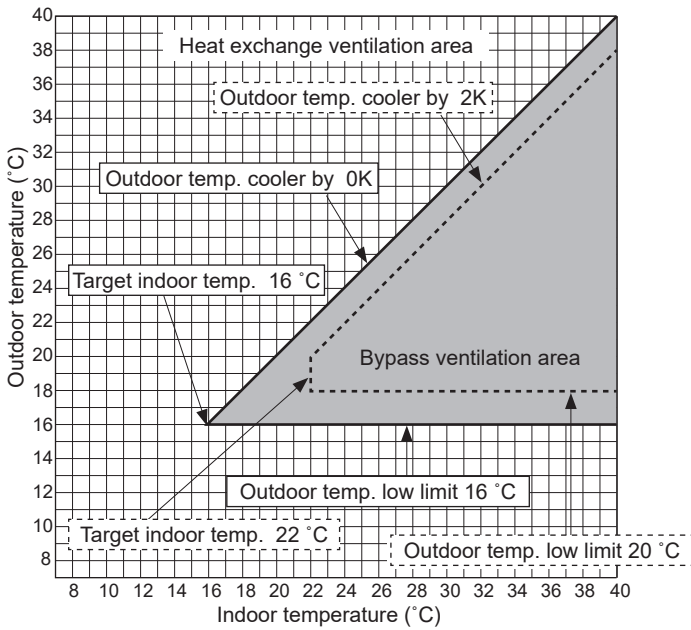

#### Note

- Conditions of prohibiting bypass ventilation: In the following conditions, the ventilation mode switches to the heat exchange ventilation mode.
  - Outdoor temperature: 8°C or lower (condensation prevention on the product).  
The prohibited conditions will be cancelled if the outdoor temperature becomes 10°C or higher.
  - When outdoor temperature thermistors or indoor temperature thermistors are in malfunction.
  - When a slim air-conditioner, interlocked with the product, is operating in the fan operation mode or heating mode.



#### 6.4.4.1 Accessing the «Auto bypass» screen

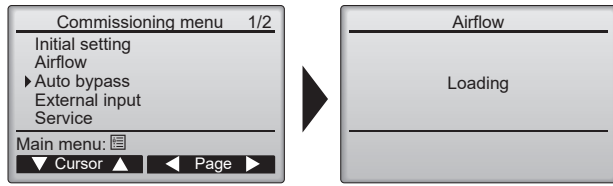

Press the **F1** and **F2** button to move the cursor.  
Press the **✓** button to go to the next screen.

The product data is loaded before the screen will appear.  
[Loading] is displayed. (10-60 seconds)

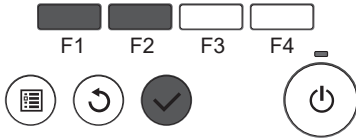

#### 6.4.4.2 The Auto bypass settings

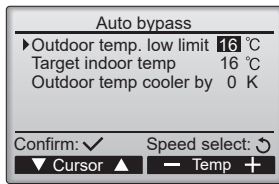

Press the **F1** and **F2** button to move the cursor.  
Press the **F3** and **F4** button to change the setting value.  
Press the **✓** button to save the changes.

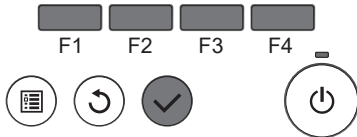

## 6.4.5 External input

The product has external input terminals. (See below.)

Function name	Input	Terminal
Analog input 1	0 -10 VDC	TM200 1(+,-)
Analog input 2	0 -10 VDC	TM200 2(+,-)
Live switch	220-240 VAC	Power cable LS (Black)
Volt-free contact	Contact input	TM201 ③-④

On the «External input» screen, you can set the operation for the external input.

### Note

- The product operates according to the highest fan speed input from the external input of the effective settings. When the fan speed is determined by the external input,  is displayed on the «Main display» screen.
- When the icon is displayed, the operation of the product may differ from the fan speed displayed on the controller. Also, a lower speed cannot be selected by the controller. (Note that a higher speed can be selected.)

### 6.4.5.1 Accessing «Analog input 1» screen

(Take the same process for Analog input 2, Live switch, and Volt-free contact screens.)

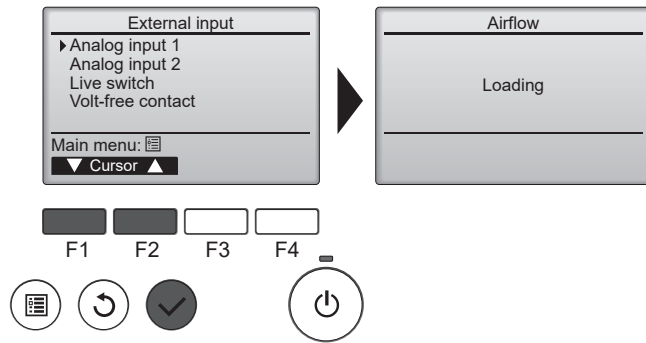

Press the **[F1]** and **[F2]** button to move the cursor.

Press the  button to go to the next screen.

The product data is loaded before the screen will appear. [Loading] is displayed. (10-60 seconds)

### 6.4.5.2 Analog input 1 (Take the same process for Analog input 2.)

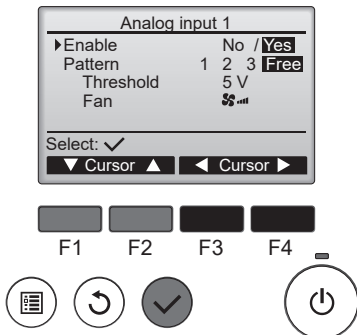

Press the **[F1]** and **[F2]** button to move the cursor.

Press the **[F3]** and **[F4]** button to change the setting value.

Press the  button to save the changes.

[Enable]: Select [Use(Yes) / No use(No)] for Analog input 1.  
The factory default setting: No













[Pattern]: Change the operation pattern for Analog input 1.  
The factory default setting: 1

[Threshold]: Change the threshold of the input voltage for the [Pattern=Free] operation.  
The factory default setting: 5 V

[Fan]: Change the operating fan speed if the input voltage in the [Pattern=Free] operation exceeds the threshold.  
The factory default setting: 

[Threshold] and [Fan] will be displayed only when [Pattern=Free] is selected.

The table shows the conditions for operation patterns.

Pattern	Input voltage [VDC]	CO <sub>2</sub> concentration [ppm]	Fan speed	Remarks
1	0.0 - 2.6	0 - 520		<ul style="list-style-type: none"> <li>- Select the CO<sub>2</sub> sensor whose relation between the CO<sub>2</sub> concentration and the output voltage is 2000 ppm = 10 VDC.</li> <li>- The fan speed will be the highest if the input voltage exceeds 6.0 VDC. (For 6.0 VDC or lower, refer to the left side of the table.)</li> <li>- The input voltages and CO<sub>2</sub> concentrations are standards. (Values are not guaranteed.)</li> <li>- If the input voltage is somewhere in between, the fan speed varies depending on the conditions.</li> <li>- When [Skipped] is selected for the fan speed on the «Control mode» screen, the fan speed will be one lower level.</li> </ul>
	3.0 - 4.1	600 - 820		
	4.5 - 5.6	900 - 1120		
	6.0 or more	1200 or more		
2	0.0 - 2.1	0 - 420		<ul style="list-style-type: none"> <li>- Select the CO<sub>2</sub> sensor whose relation between the CO<sub>2</sub> concentration and the output voltage is 2000 ppm = 10 VDC.</li> <li>- The fan speed will be the highest if the input voltage exceeds 5.0 VDC. (For 5.0 VDC or lower, refer to the left side of the table.)</li> <li>- The input voltages and CO<sub>2</sub> concentrations are standards. (Values are not guaranteed.)</li> <li>- If the input voltage is somewhere in between, the fan speed varies depending on the conditions.</li> <li>- When [Skipped] is selected for the fan speed on the «Control mode» screen, the fan speed will be one lower level.</li> </ul>
	2.5 - 3.4	500 - 680		
	3.8 - 4.6	760 - 920		
	5.0 or more	1000 or more		
3	0.0 - 1.0	/	—	<ul style="list-style-type: none"> <li>- Input voltage: 0.0-1.0 VDC: The fan speed can be set by the controller. Input voltage: 1.5 VDC or higher: The fan speed cannot be set by the controller.</li> <li>- If the input voltage is somewhere in between, the operation will be unstable.</li> <li>- When [Skipped] is selected for the fan speed on the «Control mode» screen, the fan speed will be one lower level.</li> </ul>
	1.5 - 2.5	/		
	3.5 - 4.5	/		
	5.5 - 7.0	/		
	8.5 - 10.0	/		
Free	Depends on the Threshold.	/	Depends on the Fan.	<ul style="list-style-type: none"> <li>- If the threshold exceeds the input voltage, the product operates at the fan speed set on the Fan.</li> <li>- The fan speed cannot be changed by the input voltage change for 15 minutes after the input voltage change exceeding the threshold.</li> <li>- The fan speed set to Skipped on the «Control mode» screen is not displayed.</li> </ul>

### Note

- Below settings are required to display the CO<sub>2</sub> concentration on the «Main display» screen.
- In the function setting, enable the indication of the CO<sub>2</sub> sensor. (See 6.4.6.3 and 6.5.)
- Connect the CO<sub>2</sub> sensor to the terminal for Analog input 1. (The sensor value for Analog input 2 is not displayed.)
- Set Analog input 1 to Pattern=1 or 2. (When Pattern =3 or Free is selected, [--- ppm] is displayed on the «Main display» screen.)

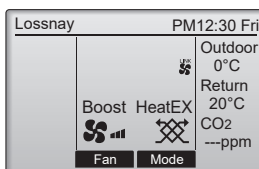

### 6.4.5.3 Live switch

Set the operation for the live switch input (220-240 VAC input linked with a lighting switch etc.).

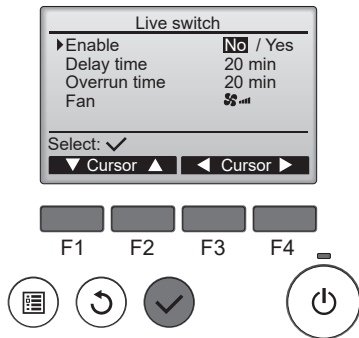

Press the **F1** and **F2** button to move the cursor.

Press the **F3** and **F4** button to change the setting value.

Press the  button to save the changes.

[Enable]: Select [Use(Yes)/No use(No)] of the Live switch.  
The factory default setting: *No*

[Delay time]: Change the delay time for the start of the Live switch operation from switch input ON.  
The factory default setting: *20 min*  
Setting range: 0-120 mins (5-min intervals)

[Overrun time]: Change the extension time from turning on the switch input to the end of the live switch operation.  
The factory default setting: *20 min*  
Setting range: 0-120 mins (5-min intervals)

[Fan]: Change the fan speed from the start to the end of the live switch operation.  
The factory default setting: 

### 6.4.5.4 Volt-Free contact

Set the operation for Volt-free contact input (input linked with non-voltage contact etc.).

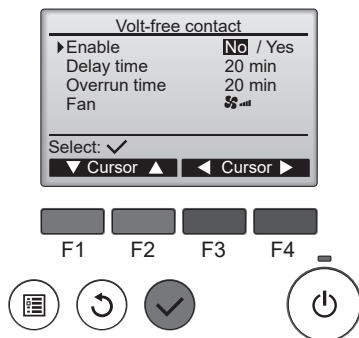

Press the **F1** and **F2** button to move the cursor.

Press the **F3** and **F4** button to change the setting value.

Press the  button to save the changes.

[Enable]: Select [Use(Yes)/No use(No)] of the Volt-Free contact.  
The factory default setting: *No*

[Delay time]: Change the delay time for the start of the Volt-Free contact operation from switch input ON.  
The factory default setting: *20 min*  
Setting range: 0-120 mins (5-min intervals)

[Overrun time]: Change the extension time from turning off the switch input to the end of the Volt-Free contact operation.  
The factory default setting: *20 min*  
Setting range: 0-120 mins (5-min intervals)

[Fan]: Change the fan speed from the start to the end of the Volt-Free contact operation.  
The factory default setting: 

## 6.4.6 Service

### 6.4.6.1 Accessing the «Service menu» screen

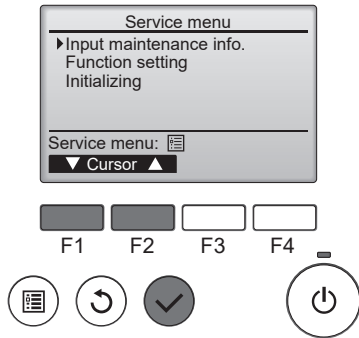

Press the **F1** and **F2** button to move the cursor.  
Press the **✓** button to go to the next screen.

### 6.4.6.2 Input maintenance info.

The following can be set.

The information input at (1), (2), and (3) is displayed on the «Error information» screen.

- (1) Model name input: Model names can be registered. (Up to 18 characters)
- (2) Serial No. input: Product serial No. can be registered. (Up to 8 characters)
- (3) Dealer information input: Dealers' phone numbers can be registered. (Up to 13 characters)
- (4) Initialize maintenance info.: The information set at (1), (2), and (3) above can be initialized.

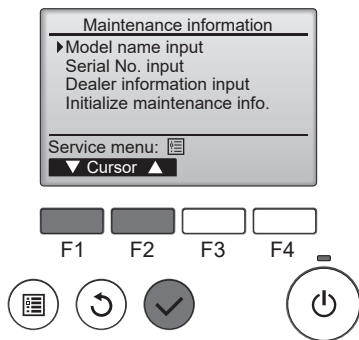

Press the **F1** and **F2** button to move the cursor.  
Press the **✓** button to go to the next screen.

### 6.4.6.3 Function setting

Set various functions.

#### Note

- The «Function setting» screen will not be displayed when the product operation is not stopped. Press the **⏻** button on the «Service menu» screen to stop the operation.

- (1) M-Net address: Use [0]. Other than [0], functions (2) and (3) cannot be used.
- (2) Function No.: Displays [Function No.] (See **6.5 Function setting**)
- (3) Data: Displays the setting for [Function No.] (See **6.5 Function setting**)
- (4) Function: Select Set (Setting)/Conf (Information confirmation) of [Function No].

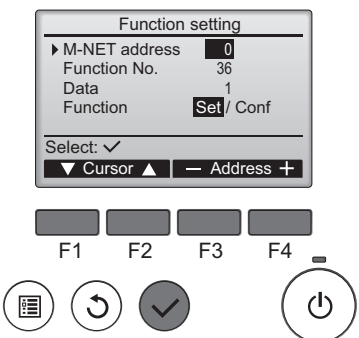

Press the **F1** and **F2** button to move the cursor.  
Press the **F3** and **F4** button to change the setting value.  
Press the **✓** button to go to the next screen.

### 6.4.6.4 Initializing

The setting values changed by the controller are returned to the factory default setting.

#### Note

- The «Function setting» screen will not be displayed when the product operation is not stopped. Press the  button on the «Service menu» screen to stop the operation.

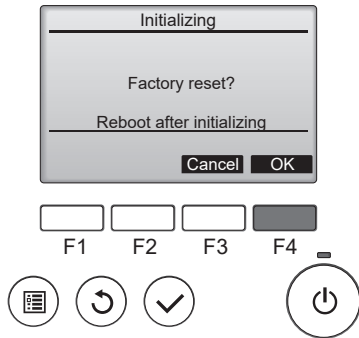



Press the **F4** button to initialize the data.

The product will restart automatically after initializing the data.

### 6.4.7 Restriction (No function)

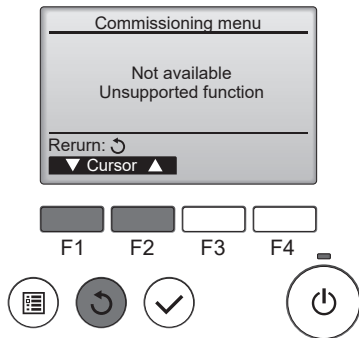
The product does not have this function.



Press the  button to return to the previous screen.

### 6.4.8 Error information

If an error occurs, the following screen will be displayed.

Check the abnormal condition, stop the operation, and consult your dealer.

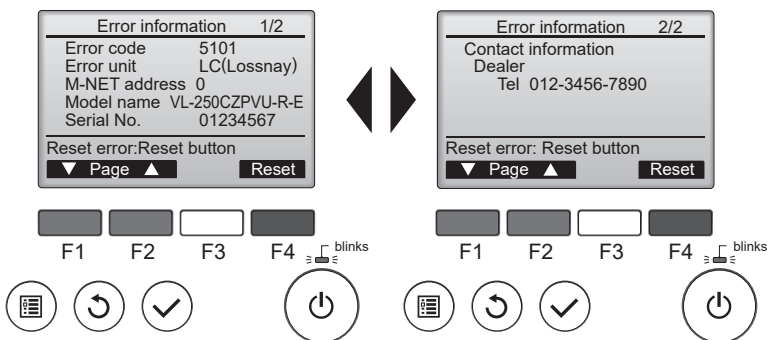

Press the **F1** and **F2** button to change the page.

Press the **F4** button to move to the Reset screen.

Model name, Serial No. and Dealer information will be displayed only when they are set at 6.4.6.2.

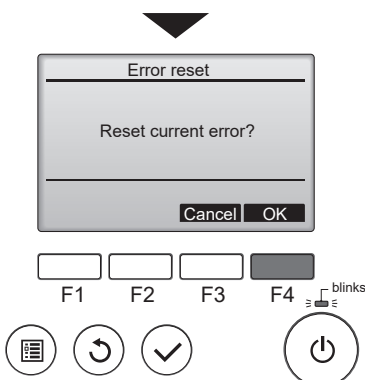

Press the **F4** button to reset the error information.

### 6.4.9 Error history

You can check the past error history.  
Error state cannot be reset from this screen.

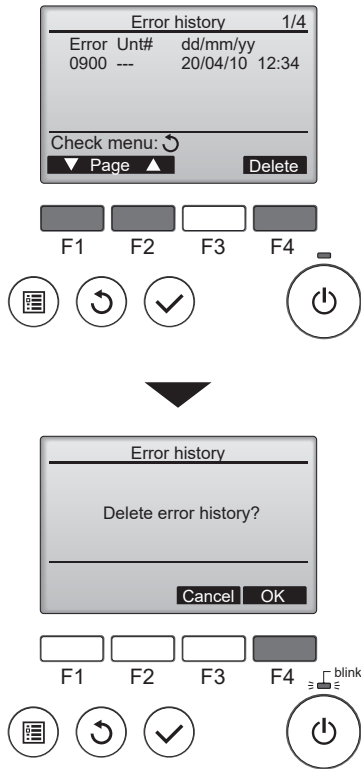

Press the **F1** and **F2** button to change the page.  
Up to 4 pages, 12 cases can be stored in the error history.  
Press the **F4** button to move to the Reset screen.

Press the **F4** button to reset the error information.

### 6.4.10 Run time

You can check the powered time and fan operation time of the product.

#### 6.4.10.1 Accessing the «Run time» screen

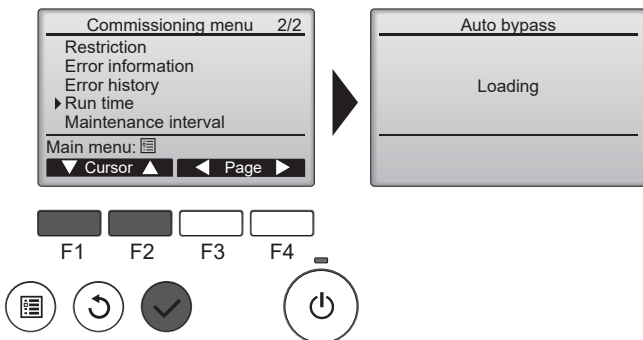

Press the **F1** and **F2** button to move the cursor.  
Press the **✓** button to go to the next screen.

The product data is loaded before the screen will appear.  
[Loading] is displayed. (10-60 seconds)

#### 6.4.10.2 Indication of Run time

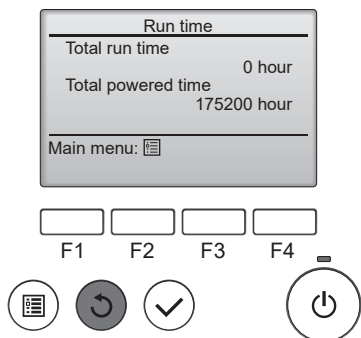

Press the **↺** button to return to the previous screen.  
[Total run time]: Operation time of ventilator.  
[Total powered time]: Product powered time.

## 6.4.11 Maintenance interval

Set the maintenance interval of the filters.

After the fan operation time exceeds the product maintenance interval, the maintenance sign (  ) will be displayed on the «Main display» screen.

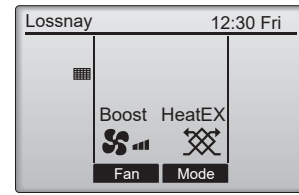

### 6.4.11.1 Accessing the «Maintenance interval» screen

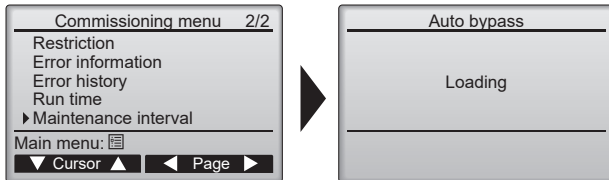

Press the **F1** and **F2** button to move the cursor.

Press the  button to go to the next screen.

The product data is loaded before the screen will appear. [Loading] is displayed. (10-60 seconds)

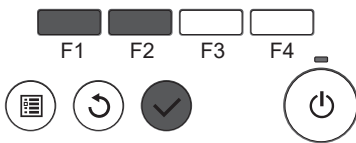

### 6.4.11.2 Indication of Maintenance interval

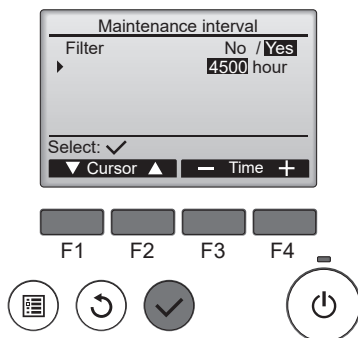

Press the **F1** and **F2** button to move the cursor.

Press the **F3** and **F4** button to change the setting value.

Press the  button to go to the next screen.

[Filter]: Select [Yes/No] to show the maintenance sign on the «Main display» screen.

The factory default setting: Yes

hour: Change the maintenance interval.

The factory default setting: 4500 hours





## 6.5 Function setting

### Function setting list

Function No.	Function name	Function setting value										Factory default setting	Function description
		[0]	[1]	[2]	[3]	[4]	[5]	[6]	[7]	[8]	[9]		
1	1: Filter maintenance indicator / 2: Fan power increase	—	1: Yes / 2: No	1: No / 2: No	1: Yes / 2: Yes	—	—	—	—	—	—	1	1: Set the filter maintenance indication to show/hide. 2: Set Use/No use of the function that increases the fan output every 1/3 of 6.4.11 Maintenance interval passes. - This function cannot be used when the fan output is set to the highest (100%).
5	Power recovery mode	—	Stop	Run	Auto- matic recovery	—	—	—	—	—	—	3	Set the operation mode when the power is recovered after the product stopped. [1] Stop: The operation mode becomes stop. [2] Run: The operation mode becomes running. [3] Automatic recovery: The operation mode becomes the mode that was set before the power failure.
36	Outdoor temperature indication	Hide	Show	—	—	—	—	—	—	—	—	0	Set to show/hide the temperature detected by the built-in thermistors. Set the settings of 6.4.2.4 also.
37	Indoor temperature indication	Hide	Show	—	—	—	—	—	—	—	—	0	No.36: <i>Lo</i> is displayed when lower than 2°C and <i>Hi</i> is displayed when 36°C or higher. No.37: <i>Lo</i> is displayed when lower than 9°C and <i>Hi</i> is displayed when 37°C or higher. No.38: This is the same as No.37.
38	Supply air (calculated value) temperature indication	Hide	Show	—	—	—	—	—	—	—	—	0	<b>Note</b> If both function settings No. 38 and 84 are [1], only the function setting No. 84: CO <sub>2</sub> concentration is displayed on the «Main display» screen. (Since the same display position is allocated, the priority is given to the indication of function setting No.84: CO <sub>2</sub> concentration.)
39	Correction of temperature exchange efficiency (tens digit)	Function setting value: 0 to 9 → Temperature exchange efficiency (tens digit): 0 to 9										8	Set the value of temperature exchange efficiency used for the calculated value of No.38 Supply air temperature indication.
40	Correction of temperature exchange efficiency (ones digit)	Function setting value: 0 to 9 → Temperature exchange efficiency (ones digit): 0 to 9										5	Factory default setting: 85%
41	Correction of outdoor temperature	Function setting value: 0 to 14 → Correction of outdoor temperature: -7°C to 7°C (1°C intervals)										7	When No.36 Outdoor temperature indication and No.37 Indoor temperature indication are set to <i>Show</i> , set the correction value of the temperature shown on the controller. Example: If the temperature detected by the built-in thermistor is 20°C and the correction value is +3°C (the function setting value is 10), the temperature indicated by the controller will be 23°C.
42	Correction of indoor temperature	Function setting value: 0 to 14 → Correction of indoor temperature: -7°C to 7°C (1°C intervals)										7	<b>Note</b> - The indication value is not corrected when <i>Lo</i> or <i>Hi</i> . - Correction values are not reflected to the control (such as «Auto bypass») using outdoor/indoor temperatures.

Function No.	Function name	Function setting value									Factory default setting	Function description	
		[0]	[1]	[2]	[3]	[4]	[5]	[6]	[7]	[8]			[9]
57	External output setting 1	—	Exhaust air fan monitor	Supply air fan monitor	Supply air after-heater	—	—	—	—	—	—	1	<p>Set the ON/OFF conditions of terminal blocks TM3 9-10.</p> <p>[1] Exhaust air fan monitor: The terminal blocks turn ON/OFF in line with the operation/stop of the exhaust air fan. (The terminal blocks will perform the operation which is the same as ON/OFF of the controller.)</p> <p>[2] Supply air fan monitor: The terminal blocks turn ON/OFF in line with the operation/stop of the supply air fan. (Depending on the conditions such as outdoor temperatures, the terminal blocks will stop automatically.)</p> <p>[3] Supply air after-heater: The output is turned ON 10 seconds after the supply air fan operation./ The supply air fan stops three minutes after the output is turned OFF.</p> <p>- Set the setting when supply air after-heaters are connected.</p>
58	External output setting 2	—	Bypass ventilation monitor	Supply air preheater	—	—	—	—	—	—	—	1	<p>Set the ON/OFF conditions of terminal blocks TM3 7-10.</p> <p>[1] Bypass ventilation monitor: The terminal blocks turn ON/OFF in line with the status (bypass/heat exchange ventilation) of the ventilation mode. (The terminal blocks turn ON/OFF in line with the built-in bypass damper.)</p> <p>[2] Supply air preheater: The output is turned ON 10 seconds after the supply air fan operation./ The supply air fan stops three minutes after the output is turned OFF.</p> <p>- Set the setting when supply air preheaters are connected.</p> <p>- The output of the terminal blocks become OFF when the outdoor temperature is 15°C or higher.</p> <p>- The output ON/OFF conditions can be changed at the function settings Nos.59 and 60.</p>
59	Conditions of preheaters ON (Function setting No.58: Supplementally setting)	Function setting value: 0 to 15 → Threshold of outdoor temperature: 0°C to -15°C (1°C intervals)									0	<p>Set the ON/OFF conditions of the function setting No.58 [2] Supply air preheater.</p> <p>No.59:</p>	
60	Conditions of preheaters OFF (Function setting No.58: Supplementally setting)	1 hour	2 hours	3 hours	4 hours	5 hours	—	—	—	—	—	0	<p>Set the threshold of the outdoor temperature whose output of preheaters turns ON. (The output turns ON when it becomes lower than the threshold temperature.</p> <p>No.60:</p> <p>Set the time to turn OFF the output of preheater after turning ON the output.</p>

Function No.	Function name	Function setting value										Factory default setting	Function description	
		[0]	[1]	[2]	[3]	[4]	[5]	[6]	[7]	[8]	[9]			
81	External output setting 3	Mal-function monitor	Outdoor air shutter	—	—	—	—	—	—	—	—	—	0	<p>Set the ON/OFF conditions of terminal blocks TM3 8-10.</p> <p>[1] Malfunction monitor: Turns the output ON when a malfunction occurs on the product. (This is used to indicate malfunctions aside from the controller.)</p> <p>[2] Supply air shutter: Set the setting so that the output ON/OFF match with the open/closed of the shutter installed on the OA duct.</p> <p>- Output ON (shutter: open) conditions: 10 seconds before starting the supply air operation</p> <p>- Output OFF (shutter: closed) conditions: The built-in thermistors detect that the outdoor temperature is -18°C or lower and 20 seconds have elapsed after the supply air fan stopped.</p>
82	Standard air speed setting			—	—	—	—	—	—	—	—	—	0	<p>Set the base notch.</p> <p>The setting can be changed in 6.4.2.7 Control mode. The priority is given to the latest setting.</p>
84	CO <sub>2</sub> concentration indication	Hide	Show	—	—	—	—	—	—	—	—	—	0	<p>Set Show/Hide the CO<sub>2</sub> concentration values connected to the Analog input 1.</p> <p>Set the settings of 6.4.2.4, and 6.4.5.2 also.</p> <p><i>Lo</i> is displayed when lower than 250 ppm and <i>Hi</i> is displayed when 2200 ppm or higher.</p> <div style="border: 1px solid black; padding: 2px;"> <p><b>Note</b></p> <p>If both function settings No. 38 and 84 are [1], only the function setting No. 84: CO<sub>2</sub> concentration is displayed on the «Main display» screen. (Since the same display position is allocated, the priority is given to the indication of function setting No.84: CO<sub>2</sub> concentration.)</p> </div>

In the following conditions, error code 3126 (malfunction on external devices) is displayed on the controller and the output of the function setting No.81 [1] Malfunction monitor turns ON.

- When the built-in OA thermistor detects 15°C or higher within 15 minutes from the start of output of the supply air preheater/after-heater.
- When the built-in OA thermistor detects -10°C or lower 60 minutes after the start of output of the supply air preheater/after-heater.

## 6.6 Error list

No	Error item	Error code	Unit operation	Error code reset	Description
1	Commissioning	0900	Commissioning operation	End the commissioning	The error is indicated when the product is in operation in the commissioning mode.
2	External device error	3126	Heater output: OFF	Stop the product.	The error is indicated when an abnormal temperature is detected by the built-in OA thermistor. It is assumed that there are wrong connections or wrong capacities of heaters.
3	Fan motor error	4116	Fan output: OFF Heater output: OFF	Stop the product.	Failure in fan motor
4	Temperature sensor error	5101	Supply air fan output: OFF Heater output: OFF Bypass ventilation is prohibited.	Cancel the error state.	The error is indicated when the built-in OA thermistor is in malfunction.
5	RA temperature sensor error	5102	The Heat exchange ventilation is fixed when the ventilation mode is Auto.	Cancel the error state.	The error is indicated when the built-in RA thermistor is in malfunction.
6	Function setting error	7113	Fan output: OFF Heat exchange ventilation is fixed.	Power supply reset	There is an error in the SW6 setting.

## 6.7 Trial operation

### 6.7.1 Operation check by using the controller

After installing the product (mounting, wiring, controller's setting), please check the operation of the system.

#### ■ Perform trial operation with the user in attendance.

- Noise sometimes increases for several minutes after the power to the product is turned off. This is operation to maintain the ventilation air volume at the appropriate volume, and is not a malfunction.
- It is difficult to tell the ventilation state when there is wind outside or during operation of a range hood fan, etc. When turning on the power, stop operation of the range hood fan or other noise sources.

Press each of the buttons by following the procedure below to check that operation is normal.

Operation Item	Operation Pad	Display	Step
1. Powering on			Turn the power on *It takes approximately five minutes to switch the screen.
2. Starting operation	ON/OFF lamp 		When power is supplied at factory default, the fan starts running. (See: 6.4.2.7 Control mode [Enable OFF button])
3. Selecting air volume			Press the <b>[F2]</b> button The fan speed is switched At factory default setting,  is skipped. (See: 6.4.2.7 Control mode [Fan Speed])
4. Selecting the ventilation mode			Press the <b>[F3]</b> button The ventilation mode switches in order <i>Automatic</i> → <i>Heat exchange</i> → <i>Bypass</i> At factory default setting,  is skipped. (See: 6.4.2.7 Control mode [Manual bypass])
5. Stopping operation	ON/OFF lamp 		Power break At factory default setting, the ON/OFF button does not stop the product. (See: 6.4.2.7 Control mode [Enable OFF button])

\* When the backlight is off, pressing any button turns the backlight on and does not perform its function. (Except the button)

## 6.7.2 Operation check

This is the function to check the operations of externally connected devices such as heaters. You can check the following specifications:

- When the output devices such heaters, malfunction monitors, and operation monitors are connected
- When the outdoor temperature is 8°C or lower (bypass damper operation check)

Operation method

- (1) Withdraw the control box.
- (2) Supply the product with power.
- (3) Turn On the commissioning switch (DIP-SW2-1). (Error code 0900 is displayed on the controller.)

Terminal	Function		Minutes					Seconds							
	No.	Data	0	10	20	30	40	50	0	10	20	30	0	0	0
-	-	-	FanSpeed	STOP	SS (purge)					STOP	SS (purge)				
-	-	-	Ventilation mode	Bypass					HeatEX						
TM3 7-10	58	1	Bypass monitor output	OFF	ON					OFF					
		2	Pre-heater output	OFF					ON						
TM3 9-10	57	1	EA fan monitor output	ON											
		2	SA fan monitor output	ON											
		3	SA fan monitor output delay operation	OFF										ON	
TM3 8-10	81	0	Malfunction monitor output	ON											
		1	External shutter output	OFF	ON										

- (4) Check that each function is operating properly.
- (5) Turn OFF the commissioning switch (DIP-SW2-1).

## 6.7.3 If trouble occurs during trial operation

Symptom	Remedy	Check																					
Will not operate even when the operation switch for the controller is pressed.	<ul style="list-style-type: none"> <li>• Check the power supply. (The specified power supply is single-phase 220-240 V / 50 Hz, 220 V / 60 Hz)</li> <li>• Check that there is 5 cm or more separating transmission cable from the power supply cable.</li> <li>• Run the product independently using the trial operation switch (SW2-1) and check if it runs. <table border="1" style="margin-left: 20px;"> <tr> <td>The product runs</td> <td>→</td> <td>Check the signal lines</td> </tr> <tr> <td>The product doesn't run</td> <td>→</td> <td>Check the power supply</td> </tr> </table> </li> <li>• Check if there are two or more controller connected. (The maximum is one.)</li> <li>• Check that the wiring between the product and the controller is within 50 m</li> </ul>	The product runs	→	Check the signal lines	The product doesn't run	→	Check the power supply																
The product runs	→	Check the signal lines																					
The product doesn't run	→	Check the power supply																					
The product does not stop.	<ul style="list-style-type: none"> <li>• Check that the trial operation switch (SW2-1) is set to off.</li> </ul>																						
The inspection indicator lamp (LED 1 Green) in the control box flashes.	<table border="1" style="width: 100%;"> <tr> <td>1 flash</td> <td>Fault on supply fan motor</td> <td rowspan="11" style="text-align: center; vertical-align: middle;">Turn the power off and consult your dealer.</td> </tr> <tr> <td>2 flashes</td> <td>Fault on exhaust fan motor</td> </tr> <tr> <td>4 flashes</td> <td>Fault on OA thermistor</td> </tr> <tr> <td>5 flashes</td> <td>Not used on this model</td> </tr> <tr> <td>6 flashes</td> <td>Not used on this model</td> </tr> <tr> <td>7 flashes</td> <td>Not used on this model</td> </tr> <tr> <td>8 flashes</td> <td>Not used on this model</td> </tr> <tr> <td>9 flashes</td> <td>Fault on controller communication</td> </tr> <tr> <td>10 flashes</td> <td>Fault on function setting</td> </tr> <tr> <td>11 flashes</td> <td>Fault on power supply to controller</td> </tr> </table>	1 flash	Fault on supply fan motor	Turn the power off and consult your dealer.	2 flashes	Fault on exhaust fan motor	4 flashes	Fault on OA thermistor	5 flashes	Not used on this model	6 flashes	Not used on this model	7 flashes	Not used on this model	8 flashes	Not used on this model	9 flashes	Fault on controller communication	10 flashes	Fault on function setting	11 flashes	Fault on power supply to controller	
1 flash	Fault on supply fan motor	Turn the power off and consult your dealer.																					
2 flashes	Fault on exhaust fan motor																						
4 flashes	Fault on OA thermistor																						
5 flashes	Not used on this model																						
6 flashes	Not used on this model																						
7 flashes	Not used on this model																						
8 flashes	Not used on this model																						
9 flashes	Fault on controller communication																						
10 flashes	Fault on function setting																						
11 flashes	Fault on power supply to controller																						
Abnormal vibration or abnormal noise	<ul style="list-style-type: none"> <li>• Check for loose Wall bracket.</li> <li>• Check for ducts out of position.</li> <li>• Check for loose or damaged parts.</li> <li>• Check for vane contact. (sound of foreign matter getting inside)</li> </ul>																						
Air is not supplied or discharged from grills	<ul style="list-style-type: none"> <li>• Check for foreign matter inside piping.</li> <li>• Check for ducts out of position.</li> <li>• Check piping to see if it is connected in such a way that it might cause air volume to drop or cause abnormal noise.</li> <li>• Check the ducts to see if they are bent excessively.</li> </ul>																						

\* When an inspection number blinks on the controller, follow the procedures shown in the installation and operating manuals provided with the controller.

## 7. Explaining to the User

---

- Explain to the user where the circuit breaker and the controller are located and how to clean the filters.
- Tell the user the results of checks performed using the checklist.
- Hand over the user a leaflet with the URL where this manual can be viewed.
- Explain correct use by following the descriptions in the **Instruction Manual**. In particular, **Safety Precautions** describe important notices and warnings relating to safety. Explain to the user that you should observe these.

**MITSUBISHI ELECTRIC CORPORATION**

HEAD OFFICE:

TOKYO BLDG., 2-7-3, MARUNOUCHI, CHIYODA-KU, TOKYO 100-8310, JAPAN